

20  
22

 **Beta** *Action*

**Promotion**  
valid until 30.11.2022  
Prices do not include V.A.T.

# Beta

## RSC55



**Configure  
your workshop  
on-line**

**WWW.RSC55.COM**

<b>WORKSHOP EQUIPMENT C45PRO - RSC55</b>	<b>2÷4</b>	
<b>CONTAINERS</b>	<b>5÷10</b>	
<b>ASSORTMENT AND THERMOFORMED TRAYS</b>	<b>11÷16</b>	
<b>COMBO - MODULAR SYSTEM</b>	<b>17-18</b>	
<b>WORKBENCHES</b>	<b>20-21</b>	
<b>TROLLEYS AND BASKETS</b>	<b>19 - 21 - 22</b>	
<b>TOOL BAGS</b>	<b>23÷26</b>	
<b>WRENCHES</b>	<b>27÷30</b>	
<b>SCREWDRIVERS</b>	<b>31</b>	
<b>COLOR CODE ITEMS</b>	<b>32 - 33</b>	
<b>SOCKETS</b>	<b>34÷36</b>	
<b>TORQUE WRENCHES</b>	<b>37 - 38</b>	
<b>PLIERS</b>	<b>39 - 40</b>	
<b>DRILLING AND THREADING TOOLS</b>	<b>41 - 42</b>	
<b>HAMMERS AND CHISELS</b>	<b>43</b>	
<b>GENERAL MAINTENANCE TOOLS</b>	<b>44÷49</b>	
<b>LIGHTING</b>	<b>50÷52</b>	
<b>1000V INSULATED TOOLS</b>	<b>53 - 54</b>	
<b>CUTTING TOOLS</b>	<b>55</b>	
<b>BETA CHEMICALS</b>	<b>56</b>	
<b>ABRA BETA</b>	<b>57 - 58</b>	
<b>ANGLE GRINDERS</b>	<b>59</b>	
<b>AUTOMOTIVE</b>	<b>60÷84</b>	
<b>CHAIN BLOCKS ROBUR</b>	<b>85 - 86</b>	
<b>PNEUMATIC TOOLS</b>	<b>86÷91</b>	
<b>SAFETY FOOTWEAR</b>	<b>92÷97</b>	
<b>WORKWEAR</b>	<b>98÷104</b>	

# C45PRO

# WORKSHOP EQUIPMENT COMBINATION C45PRO

## // C45PRO

Combination comprising:

- Fixed module with 7 drawers (C45PRO M7)
- Fixed service module (C45PRO MS)
- Mobile roller cab with 7 drawers (C45PRO C7)
- Two-door tool cabinet (C45PRO AS2)
- 3 perforated tool panels (C45PRO PF)
- 3 wall-mounted cabinets (C45PRO PM)
- 3 wall brackets, wide type (C45PRO SL)
- 1 wall bracket, narrow type (C45PRO SS)



### // 045000001 C45PRO X

€ 3.200,00 € 2.580,00

- Worktop made of stainless steel coated MDF (C45PX/3-2,0MT)



305 kg

### // 045000002 C45PRO W

€ 3.110,00 € 2.500,00

- Multi-ply wood worktop (C45PW/3-2,0MT)



303 kg



## // C45PRO A

Combination comprising:

- Fixed module with 7 drawers (C45PRO M7)
- Fixed service module (C45PRO MS)
- Fixed two-door module (C45PRO MA)
- 3 wall-mounted cabinets (C45PRO PM)
- 3 perforated tool panels (C45PRO PF)
- 2 wall brackets, wide type (C45PRO SL)
- 2 wall brackets, narrow type (C45PRO SS)



### // 045000003 C45PRO AX

€ 2.235,00 € 1.805,00

- Worktop made of stainless steel coated MDF (C45PX/3-2,0MT)



206 kg

### // 045000004 C45PRO AW

€ 2.145,00 € 1.725,00

- Multi-ply wood worktop (C45PW/3-2,0MT)



204 kg

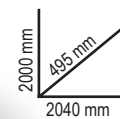

## // C45PRO B

Combination comprising:

- Fixed module with 5 drawers (C45PRO M5)
- Fixed two-door module (C45PRO MA)
- Single-door cabinet (C45PRO AS1)
- 2 wall-mounted cabinets (C45PRO PM)
- 2 perforated tool panels (C45PRO PF)
- 2 wall brackets, wide type (C45PRO SL)
- 1 wall bracket, narrow type (C45PRO SS)



045000021 **C45PRO BX**  
 € 1.980,00 € 1.590,00

- Worktop made of coated MDF stainless steel (C45PX/2-1,3MT)

191 kg



045000022 **C45PRO BW**  
 € 1.895,00 € 1.525,00

- Multi-ply wood worktop (C45PW/A2-1,3MT)

190 kg



## // C45PRO D

Combination comprising:

- 1 mobile roller cab with 7 drawers (C45PRO M7)
- 1 mobile roller cab with 7 drawers (C45PRO C7)
- 1 fixed service module (C45PRO MS)
- 1 fixed module with 5 drawers (C45PRO M5)

- 1 fixed module with 2 doors (C45PRO MA)
- 5 perforated tool panels (C45PRO PF)
- 5 wall-mounted cabinets (C45PRO PM)
- 7 wall brackets, wide type (C45PRO SL)
- 2 wall brackets, narrow type (C45PRO SS)
- 2 single-door tool cabinets (C45PRO AS1)



045000031 **C45PRO DX**  
 € 6.320,00 € 5.080,00

- 1 worktop made of stainless steel coated MDF 2,0 m (C45PX/3-2,0MT)
- 1 worktop made of stainless steel coated MDF 1,3 m (C45PX/2-1,3MT)
- 1 self-supporting complete corner with stainless steel coated MDF worktop (C45PRO C/X)



572 kg

2000 mm  
 495 mm  
 3500/2820 mm

045000032 **C45PRO DW**  
 € 6.100,00 € 4.910,00

- 1 multi-ply wood worktop 2 m (C45PW/3-2,0MT)
- Multi-ply wood worktop 1,3 m (C45PW/2-1,3MT)
- 1 self-supporting complete corner with wood worktop (C45PRO C/W)



568 kg

## WORKSHOP EQUIPMENT COMBINATION RSC55



055000065 **C55PB-PRO/7**  
 € 5.940,00 € 4.780,00

### WORKSHOP EQUIPMENT COMBINATION RSC55

Composed of:

#### C55B

Workbench with worktop (2050x700 mm) covered with a shockproof, nonscratch ABS coat resistant to oils and hydrocarbons.

Fitted with:

- Holes for a vice (1599F/150, to be ordered separately)
- Vertically adjustable feet

#### C55M7

Fixed module with seven drawers (588x367 mm) with ball bearing slides

- Aluminium opening system throughout length of drawer
- Drawer bases protected by foamed rubber mats
- Front centralized lock
- Can be fitted with thermoformed trays

#### C55MS

Fixed service module

- Built-in waste bin
- Paper roll compartment
- Storage drawer, 305x270 mm

#### C55/2PM + C55/PF

Tool wall system with 2 suspended cabinets

- 2 suspended cabinets, 1024x400x300 mm, with gas springs
- 2 under-cabinet panels, 1024x620x25 mm
- 2 under-cabinet perforated tool panels, 1024x620x25 mm



055000066 **C55PB-PRO/8**  
 € 4.950,00 € 4.020,00

### WORKSHOP EQUIPMENT COMBINATION RSC55

Composed of:

#### C55B

Workbench with worktop (2050x700 mm) covered with a shockproof, nonscratch ABS coat resistant to oils and hydrocarbons.

Fitted with:

- Holes for a vice (1599F/150, to be ordered separately)
- Vertically adjustable feet

#### C55C7

Mobile roller cab with seven drawers (588x367 mm) with ball bearing slides

- 4 castors Ø 100 mm, 2 fixed and 2 steering (one with brake)
- Aluminium opening system throughout length of drawer
- Drawer bases protected by foamed rubber mats
- Front centralized lock
- Can be fitted with thermoformed trays

#### C55MA

Fixed two-door module

- Push-pull opening system
- With lock
- Interior shelf, vertically adjustable

#### C55PS

Tool wall system with shutter and framework

- Aluminium shutter, vertically adjustable, with lock
- Removable perforated tool panel



# NEW

## //C37



### MOBILE ROLLER CAB

Main features:

- Sturdy multi-purpose worktop
- Quick release system made of aluminium, opening throughout length of drawer
- Corner bumpers throughout height of roller cab, to avoid damaging vehicles in garage
- Four castors Ø 125 mm: 2 fixed and 2 steering (one with brake)
- Tote-trays and holes for accommodating screwdrivers
- Built-in side bottle and paper holders, adjustable in several positions



## //C37A/7



### MOBILE ROLLER CAB WITH 7 DRAWERS WITH ANTI-TILT SYSTEM



n°	Max	Max
5	75 mm	30 kg
1	150 mm	35 kg
1	225 mm	35 kg



	Ral 2011	Ral 7016	Ral 3000	n°	Max	kg	€
C37/6	037000061	037000062	037000063	4	75 mm	30 kg	€ 621,00
				1	150 mm	35 kg	
				1	305 mm	40 kg	
C37/7	037000071	037000072	037000073	5	75 mm	30 kg	€ 643,00
				1	150 mm	35 kg	
				1	225 mm	35 kg	
C37/8	037000081	037000082	037000083	6	75 mm	30 kg	€ 678,00
				2	150 mm	35 kg	



€ 837,00 € 691,00

Ral 2011	Ral 7016	Ral 3000
037000271	037000272	037000273

## //C39

### MOBILE ROLLER CAB

- Four castors with steel cores, Ø 125 mm: 2 fixed and 2 steering (one with brake)
- Front centralized safety lock
- Sturdy multi-purpose worktop with tote-trays and holes for accommodating screwdrivers
- Pull-out drawer with opening system throughout its length
- Built-in side and rear bottle and paper holders



UPRIGHTS AND DRAWER FRONT MADE OF ALUMINIUM ALLOY + STURDINESS + LIGHTWEIGHTNESS

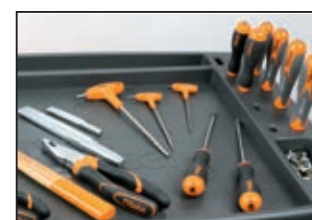

971 mm  
500 mm  
800 mm

	Ral 2011	Ral 7016	Ral 3000	n°	Max	kg	€
C39/6	039000031	039000032	039000033	4	70 mm	30 kg	€ 968,00
				1	140 mm	35 kg	
				1	280 mm	40 kg	
C39/7	039000001	039000002	039000003	5	70 mm	30 kg	€ 1.005,00
				1	140 mm	35 kg	
				1	210 mm	35 kg	
C39/8	039000041	039000042	039000043	6	70 mm	30 kg	€ 1.064,00
				2	140 mm	35 kg	

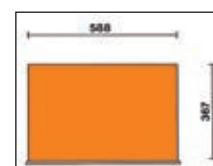

**NEW**



# DISCOVER THE NEW RSC!

Beta is proud to introduce **the new RSC product range**, designed to meet every professional's requirements and ensure remarkable reliability and high performance.

The new design, inspired by the Racing world, gives this range of cabs and trolleys a charming, unique style: based on the new colours and finishes, the new RSC product range stands out as one of a kind in the market.

The sturdy structure and the materials used guarantee high quality and a long service life, thus effectively complementing the daily work of industrial production departments, vehicle repairers and general maintainers. Furthermore, most of the RSC mobile roller cabs have been awarded prestigious TÜV certification, which is synonymous with guaranteed safety and quality, and is obtained upon successful completion of severe tests under the EK5/TA5 protocol.



## ACCESSORIES

024004901 **2400 RSC24/PL**  
~~€ 66,00~~ € 50,50

Wood worktop  
for roller cab RSC24



024004902 **2400 RSC24/PF**  
~~€ 53,00~~ € 40,50

Perforated tool panel with supports,  
for roller cab RSC24



024004909 **2400 RSC24/SPC**  
~~€ 98,00~~ € 76,50

Uchwyt na laptop,  
do wózka  
narzędziowego RSC24

- Z wymiowaną szufladą
- Nie może być stosowany z modelem RSC24AXL

**NEW**



050000901 **5000MS**  
~~€ 49,50~~ € 39,00

Folding shelf

- For use as additional worktop
- Worktop dimensions: 390x440 mm, protected by an anti-oil and anti-petrol rubber mat
- Load capacity: 20 kg.

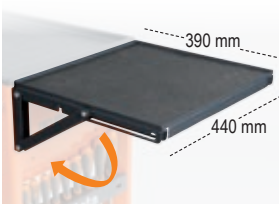

**2400 RSC24/PD**

Document holder,  
for roller cabs RSC24



**2400 RSC24/PC**

Paper roll holder



		€	€
ANTRACYT	024004907	<del>€ 30,50</del>	€ 24,50
CZARNY	024004908	<del>€ 24,50</del>	€ 24,50

		€	€
ANTRACYT	024004903	<del>€ 14,60</del>	€ 11,40
CZARNY	024004904	<del>€ 14,60</del>	€ 11,40



# //RSC24

## MOBILE ROLLER CAB

- Multi-purpose top with anti-fall edges and eight holes for accommodating screwdrivers
- Drawer bases protected by foamed rubber mats
- Four castors Ø 125 mm: 2 fixed and 2 steering (one with brake)
- Each drawer can accommodate up to 4 EVA foam or ABS thermoformed trays
- Front centralized safety lock.
- Static load capacity: 800 kg.
- Built-in bottle holder (can be applied on both sides).

The following accessories can be added:

- wood worktop 2400 RSC24/PL
- perforated tool panel 2400 RSC24/PF
- folding shelf 5000MS
- document holder 2400 RSC24/PD
- paper roll holder 2400 RSC24/PC



**NEW**

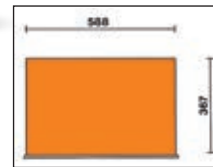
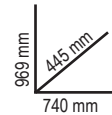

	Ral 2011	Ral 7016	Ral 5015 Ral 7016	Ral 9006 Ral 7016	Ral 9005	Ral 2011 Ral 7016	Ral 3000 Ral 7016	kg	€
RSC24/5	024004050	024004057	024004056	024004052	024004059	024004051	024004053	60	<del>€ 659,00</del> <b>€ 503,00</b>
RSC24/6	024004060	024004067	024004066	024004062	024004069	024004061	024004063	62	<del>€ 717,00</del> <b>€ 546,00</b>
RSC24/7	024004070	024004077	024004076	024004072	024004079	024004071	024004073	63	<del>€ 778,00</del> <b>€ 590,00</b>
RSC24/8	024004080	024004087	024004086	024004082	024004089	024004081	024004083	66	<del>€ 839,00</del> <b>€ 643,00</b>

RSC24/5		
n°	Max	Max
2	70 mm	25 kg
2	140 mm	30 kg
1	280 mm	35 kg

RSC24/6		
n°	Max	Max
4	70 mm	25 kg
1	140 mm	30 kg
1	280 mm	35 kg

RSC24/7		
n°	Max	Max
5	70 mm	25 kg
1	140 mm	30 kg
1	210 mm	30 kg

RSC24/8		
n°	Max	Max
6	70 mm	25 kg
2	140 mm	30 kg

# RSC24AXL

## MOBILE ROLLER CAB, WITH ANTI-TILT SYSTEM, LONG MODEL

- New ABS reinforced worktop with anti-fall edges, eight holes for accommodating screwdrivers and 6 tote trays.
- **Sturdy nylon front, with built-in label holder.**
- Drawer bases protected by foamed rubber mats.
- 4 castors, Ø 125 mm: 2 fixed and 2 steering (one with brake).
- Front centralized safety lock.
- Built-in side bottle holder (can be applied on both sides).

**Following accessories can be added:**

- Wood worktop 2400 RSC24/PL
- Document holder 2400 RSC24/PD-A
- Paper roll holder 2400 RSC24/PC-A

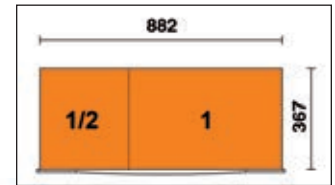
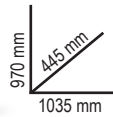

	Ral 2011 Ral 7016	Ral 7016	Ral 3000 Ral 7016	n°	↓ max	kg	€
RSC24AXL/7	024004271	024004277	024004273	5	70 mm	30 kg	€ 1.015,00
				1	140 mm	35 kg	
				1	210 mm	35 kg	
RSC24AXL/8	024004281	024004287	024004283	6	70 mm	30 kg	€ 1.087,00
				2	140 mm	35 kg	
RSC24AXL/9	024004291	024004297	024004293	8	70 mm	30 kg	€ 1.154,00
				1	140 mm	35 kg	

# RSC24L/7

## MOBILE ROLLER CAB WITH 7 DRAWERS AND SIDE SHELVES

**Main features:**

- 7 drawers (588x367 mm) with ball bearing slides: 5 drawers, 70 mm high; 1 drawer, 140 mm high; 1 drawer, 210 mm high.
- Drawer bases protected by foamed rubber mats.
- 4 castors, Ø 125 mm: 2 fixed and 2 steering with brakes.
- Front centralized lock.
- Static load capacity: 1,100 kg.
- Multi-ply wood worktop with holes for a vice (1599F/100, to be ordered separately).
- Side compartment with vertically adjustable shelf.
- Built-in paper roll holder.
- Double rear bottle holder.

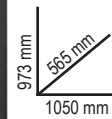

80 kg



€ 1.123,00 € 852,00

	Ral 2011 Ral 7016	Ral 7016	Ral 3000 Ral 7016	n°	↓ Max
024000371	024000377	024000373	5	70 mm	25 kg
			1	140 mm	30 kg
			1	210 mm	30 kg

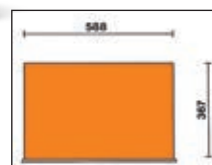

# //RSC24L-CAB

## MOBILE ROLLER CAB WITH 7 DRAWERS AND TOOL CABINET

Main features:

- 7 drawers (588x367 mm) with ball bearing slides:
  - 5 drawers, 70 mm high
  - 1 drawer, 140 mm high
  - 1 drawer, 210 mm high.
- Drawer bases protected by foamed rubber mats.
- 4 castors, Ø 125 mm: 2 fixed and 2 steering with brakes.
- Front centralized lock.
- Side tool cabinet with lockable door and vertically adjustable interior shelf.
- Static load capacity: 1,100 kg.
- Multi-ply wood worktop with holes for a vice (1599F/100, to be ordered separately).
- Built-in paper roll holder.
- Double rear bottle holder.

kg  
1100



973 mm  
585 mm  
1050 mm



€ 1.159,00 € 874,00

Ral 2011	Ral 7016	Ral 3000
Ral 7016	Ral 7016	Ral 7016
024004471	024004477	024004473

n°	mm	Max
5	70 mm	25 kg
1	140 mm	30 kg
1	210 mm	30 kg

kg 82

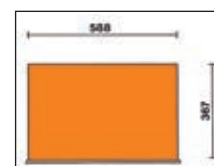

# //RSC28

## SUPERTANK TROLLEY WITH WOOD WORKTOP AND 10 DRAWERS

Main features:

- 10 drawers (588x367 mm) with ball bearing slides.
- Quick, safe system for opening and closing drawers, with nylon and fibreglass front.
- 5 side drawers:
  - 4 drawers, 70 mm high
  - 1 drawer, 210 mm high.
- 5 front drawers:
  - 4 drawers, 70 mm high
  - 1 drawer, 210 mm high.
- Drawer bases protected by foamed rubber mats.
- 4 high-capacity castors, Ø 150 mm: 2 fixed and 2 steering with brakes.
- 2 centralized safety locks.
- 3 front tool drawers.
- Multi-ply wood worktop with holes for a vice (1599F/150, to be ordered separately).
- Built-in tool compartment.
- Side compartment with foldaway door with lock.
- Built-in bottle holders.
- 135-mm-high storage compartment with plastic-covered base.

kg  
1200



943 mm  
800 mm  
1235 mm

kg 130



€ 1.990,00 € 1.505,00

Ral 2011	Ral 7016	Ral 3000
Ral 7016	Ral 7016	Ral 7016
028003001	028003007	028003003

n°	mm	Max
8	70 mm	25 kg
2	210 mm	30 kg

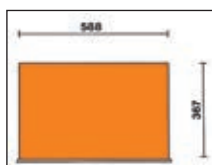

# C50S

## SERVICE TOOL TROLLEY WITH 3 DRAWERS

Main features:

- Thermoplastic worktop
- 3 drawers (588x367 mm) with ball bearing slides, 70 mm high
- Drawer bases protected by foamed rubber mats
- Front centralized safety lock
- Large lower shelf protected by an anti-oil and anti-rubber mat
- Four castors, Ø 125 mm: 2 fixed and 2 steering (one with brake)
- Static load capacity: 400 kg
- Capacity of each drawer: 15 kg, uniformly distributed
- Paper roll holder item 2400S-R/PC can be applied on request
- **Folding shelf item 5000MS can be applied on request**

kg  
400



- Convenient side screwdriver holder included
- Two side built-in spray can holders

890 mm  
460 mm  
770 mm



€ 397,00 € 320,00

Ral 2011	Ral 7016	Ral 3000
050000301	050000302	050000303

kg 38

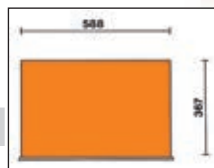

n°	mm	Max
3	70 mm	15 kg



1150 mm

050000901 **5000MS**

€ 49,50 € 39,00

Folding shelf for tool trolley item C50S RSC24-RSC24A

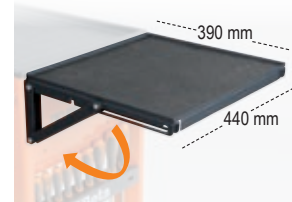

# C04TSS/7

€ 1.980,00 € 1.585,00

## MOBILE ROLLER CAB WITH 7 DRAWERS

kg  
700



made of stainless steel

- Four castors with steel cores, Ø 125 mm: 2 fixed and 2 steering (with brakes);
- Front centralized lock;
- Frame made entirely of stainless steel
- Castors, supports, ball bearings, drawer interiors and guides made of stainless steel
- Drawer handles made of aluminium



935 mm  
470 mm  
680 mm

kg 63

n°	mm	max
6	83 mm	25 kg
1	170 mm	30 kg

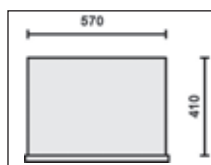
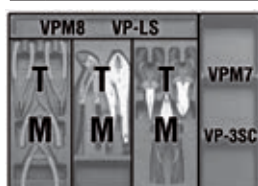

# ASSORTMENT



059880356 **5988VU/M**  
€ 1.985,00 € 1.615,00



SOFT  
MODULE  
SYSTEM

## ASSORTMENT OF 214 TOOLS IN SOFT FOAM TRAY

Recommended with: RSC24 -RSC24L/7 - C37 - C39 - RSC28 - RSC24L-CAB  
C59 - RSC55

Quantity/Description	Beta N.	TR
22 combination wrenches 6-7-8-9-10-11-12-13-14-15-16-17-18-19-20-21-22-24-27-30-32-36 mm	42	M01
11 double open end wrenches 6x7-8x9-10x11-12x13-14x15-16x17-18x19-20x22-21x23-24x27-30x32 mm	55	M30
11 double ended offset ring wrenches 6x7-8x9-10x11-12x13-14x15-16x17-18x19-20x22-21x23-24x27-30x32 mm	90	M30
9 ball head offset hexagon key wrenches $\varnothing$ 1,5+10 mm	96BPC/SC9	M30
1 socket holder	895/1	M100
1 socket holder	895/3	M100
1 socket holder	895/6	M100
13 1/4" hexagon sockets $\varnothing$ 4-4,5-5-5,5-6-7-8-9-10-11-12-13-14 mm	900	M100
9 hexagon hand sockets, long series $\varnothing$ 5-6-7-8-9-10-11-12-13 mm	900L	M100
5 1/4" socket drivers for hexagon screws $\varnothing$ 3-4-5-6-7 mm	900ME	M100
4 socket drivers for slotted head screws $\bullet$ 0,8x4-1x5,5-1,2x6,5-1,2x8 mm	900LP	M100
4 socket drivers for cross head Phillips® screws $\oplus$ PH1-PH2-PH3-PH4	900PH	M100
7 socket drivers for Torx® head screws $\odot$ T10-T15-T20-T25-T27-T30-T40	900TX	M100
1 1/4" drive extension bar 50 mm	900/20	M100
1 1/4" drive extension bar 100 mm	900/20L	M100
1 1/4" drive extension bar 150 mm	900/21	M100
1 1/4" drive universal joint	900/25	M100
1 1/4" drive spinner handle	900BG/30	M100
1 1/4" drive swivel T-handle	900/42	M100
1 1/4" reversible ratchet $\oplus$	900/55	M100
21 1/2" square drive hexagon sockets $\varnothing$ 8-10-11-12-13-14-15-16-17-18-19-20-21-22-23-24-26-27-28-30-32 mm	920A	M100
1 adaptor, 1/2" female and 3/8" male drives 125 mm	920/15	M100
1 1/2" drive universal joint 250 mm	920/25	M100
1 1/2" wobble extension bar 125 mm	920AN/125	M100
1 1/2" wobble extension bar 250 mm	920AN/250	M100
1 1/2" drive sliding T-handle 305 mm	920/42	M100
1 1/2" drive reversible ratchet $\oplus$	920/55	M100
8 1/2" sockets for Torx® head screws $\odot$ 10-12-14-16-18-20-22-24 mm	920FTX	M100
11 hexagon hand sockets $\varnothing$ 10-12-13-14-15-16-17-18-19-21-22 mm	920AL	M100
1 circlip pliers straight, internal $\varnothing$ 180 mm	1032	M129
1 circlip pliers bent, internal $\varnothing$ 170 mm	1034	M129
1 circlip pliers straight, external $\bullet$ 175 mm	1036	M129
1 circlip pliers bent, external $\bullet$ 175 mm	1038	M129
1 circlip pliers bent, external $\bullet$ 175 mm	1048	M129
1 self - locking pliers 240 mm	1052	M129
1 Diagonal cutting nippers $\angle$ 160 mm	1082BM	M129
1 construction worker's pincers 220 mm	1098	M129
1 tin snips 250 mm	1112	M129
1 electrician's scissors, straight blades	1128BM	M129
1 half-round needle nose pliers $\equiv$ 180 mm	1150BM	M129
1 Extra-long needle nose pliers $\bullet$ 160 mm	1166BM	M129
1 Extra-long bent needle nose pliers $\bullet$ 160 mm	1168BM	M129
6 screwdriver for slotted head screws $\bullet$ 2,5x50-3x75-4x100-5,5x125-6,5x150-8x200 mm	1201E	M213

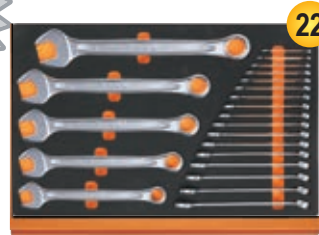

M01



M30

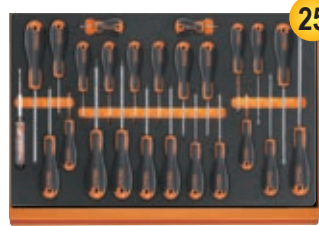

M213



M230

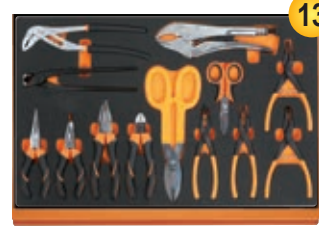

M129

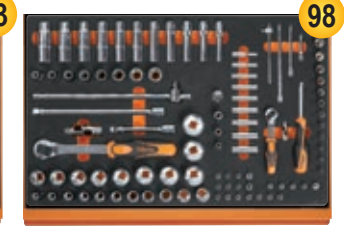

M100

1 screwdriver for slotted head screws, extra-short series $\bullet$ 4x30 mm	1201EN	M213
4 screwdriver for cross head Phillips® screws $\oplus$ PH0,60-PH1x80-PH2x100-PH3x150 mm	1202E	M213
1 screwdriver for cross head Phillips® screws, extra-short series $\oplus$ PH1x30 mm	1202EN	M213
12 screwdrivers for Torx® head screws, with handles $\odot$ T6-T7-T8-T9-T10-T15-T20-T25-T27-T30-T40-T45	1207E/TX	M213
1 mains testing screwdriver $\bullet$	1253	M213
3 drift punches 2-3-4 mm	30	M230
1 pin punches 2-3-4-5-6-8	31	M230
1 centre punch $\varnothing$ 4 mm	32	M230
1 flat chisels 150 mm	34	M230
2 flat chisels, ribbed type 200-250 mm	35	M230
1 cape chisels, standard type 125 mm	36	M230
1 engineer's hammer 500 g	1370	M230
1 soft face hammer $\varnothing$ 35 mm	1390	M230
1 measuring tape 3 m	1692	M230
1 telescopic magnet with flexible head	1712TF	M230
1 second-cut square files 200 mm	1719BMA...Q	M230
1 second-cut triangular files 200 mm	1719BMA...T	M230
1 second-cut flat files 200 mm	1719BMA...P	M230
1 second-cut half-round files 200 mm	1719BMA...M	M230
1 second-cut round files 200 mm	1719BMA...R	M230
1 steel wire brush	1737NX	M230
1 snap - off blade utility knife 18 mm	1771	M230



059040416 **5904VA/T**  
€ 1.158,00 € 962,00



## ASSORTMENT OF 102 TOOLS IN ABS

Quantity/Description	Beta N.	TR
21 combination wrenches 6-7-8-9-10-11-12-13-14-15-16-17-18-19-20-21-22-24-27-30-32 mm	42	T05
8 double open end wrenches 6x7-8x9-10x11-12x13-14x15-16x17-18x19-20x22 mm	55	+T06 T33
9 offset hexagon key wrenches $\varnothing$ 1,5+10 mm	96/SC9	T33
6 offset hexagon key wrenches $\varnothing$ 2-2,5-3-4-5-6 mm	96T	T52
8 T - handle wrenches with swivelling socket $\varnothing$ 7-8-10-12-13-14-17-19 mm	952	T63
19 1/2" square drive hexagon sockets $\varnothing$ 10-11-12-13-14-15-16-17-18-19-20-21-22-23-24-26-27-30-32 mm	920A	T83
1 1/2" drive extension bar 125 mm	920/21	T83
1 1/2" drive extension bar 255 mm	920/22	T83
1 1/2" drive universal joint	920/25	T83
1 1/2" drive sliding T-handle 305 mm	920/42	T83
1 1/2" drive reversible ratchet $\oplus$	920/55	T83
1 heavy-duty diagonal cutting nippers $\angle$ 160 mm	1084BM	T137
1 half-round needle nose pliers $\equiv$ 180 mm	1150BM	T137
1 extra-long needle nose pliers $\bullet$ 160 mm	1166BM	T137
1 circlip pliers straight, internal $\varnothing$ 180 mm	1032	T145
1 circlip pliers bent, internal $\varnothing$ 170 mm	1034	T145
1 circlip pliers straight, external $\bullet$ 175 mm	1036	T145
1 circlip pliers bent, external $\bullet$ 175 mm	1038	T145
1 self - locking pliers 240 mm	1052	T153
1 slip joint pliers boxed joints 250 mm	1048	T153
7 screwdrivers for cross head Phillips® screws $\bullet$ 2,5x50 -3x75 - 3,5x100 - 4x125 -5,5x100 - 5,5x150 - 6,5x150 mm	1260	T199
6 screwdrivers for cross head Phillips® screws $\oplus$ PH0x60 - PH0x100 - PH1x80 - PH1x120 - PH2x100 - PH2x150 mm	1262	T202
2 flat chisels, ribbed type 100-200 mm	35	T234
1 engineer's hammer 300 g	1370	T234
1 soft face hammer $\varnothing$ 35 mm	1390	T234
1 empty thermoformed tray		VP5

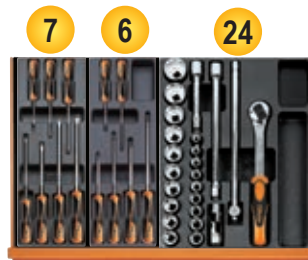

T199

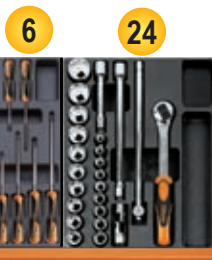

T202



T83



T145



T153



T137



T234



T52



T33



T05



T63



VP5



059040426 **5904VU/M**  
€ 843,00 € 704,00



**ASSORTMENT OF 91 TOOLS  
IN SOFT FOAM TRAY**

Recommended with: RSC24 - RSC24L/7 - C37 - C39 - RSC28 - RSC24L-CAB - C59 - RSC55



16 17 7 6



M05 M33 M199 M202

8 24



M50 M83

3 2 4 4



M137 M153 M234 M145

**Quantity/Description**

Quantity/Description	Beta N.	TR
16 combination wrenches 6÷21 mm	42	M05
8 double open end wrenches 6x7 - 8x9 - 10x11 - 12x13 - 14x15 - 16x17 - 18x19 - 20x22 mm	55	M33
9 offset hexagon key wrenches $\odot$ 1,5 - 2 - 2,5 - 3 - 4 - 5 - 6 - 8 - 10 mm	96/SC9	M33
7 screwdrivers for cross head Phillips® screws $\bullet$ 2,5x50 - 3x75 - 3,5x100 - 4x125 - 5,5x100 - 5,5x150 - 6,5x150 mm	1260	M199
6 screwdrivers for cross head Phillips® screws $\oplus$ PH0x60 - PH0x100 - PH1x80 - PH1x120 - PH2x100 - PH2x150 mm	1262	M202
8 offset hexagon key wrenches $\odot$ 2-2,5-3-4-5-6-7-8 mm	96T	M50
1 1/2" wobble extension bar 125 mm	920AN/125	M83
1 1/2" wobble extension bar 250 mm	920AN/250	M83
1 1/2" drive universal joint	920/25	M83
1 1/2" drive sliding T-handle	920/42	M83
1 1/2" drive reversible ratchet $\oplus$	920/55	M83
19 1/2" square drive hexagon sockets $\odot$ 10÷24 - 26 - 27 - 30 - 32 mm	920A	M83
1 Heavy-duty diagonal cutting nippers $\nless$ 160 mm	1084	M132
1 half-round needle nose pliers $\equiv$ 180 mm	1150	M132
1 extra-long needle nose pliers $\bullet$ 160 mm	1166	M132
1 slip joint pliers boxed joints 250 mm	1048	M153
1 self - locking pliers 240 mm	1052	M153
2 flat chisels, ribbed type 100-200 mm	35	M234
1 engineer's hammer 300 g	1370	M234
1 soft face hammer $\varnothing$ 35 mm	1390	M234
1 circlip pliers straight, internal $\odot$ 180 mm	1032	M145
1 circlip pliers bent, internal $\odot$ 170 mm	1034	M145
1 circlip pliers straight, external $\bullet$ 175 mm	1036	M145
1 circlip pliers bent, external $\bullet$ 175 mm	1038	M145



059041220 **5904VG/3M**  
€ 1.069,00 € 909,00



**ASSORTMENT OF 130 TOOLS  
IN SOFT FOAM TRAY**

Recommended with: RSC24 - RSC24L/7 - C37 - C39 - RSC28 - RSC24L-CAB - C59 - RSC55



16 5 2 8 5 4



M05 M06 M153



M50 M55 M292

10 45 4



M208 M85 M234

24 3 4

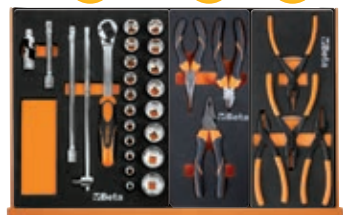

M83 M134 M145

**Quantity/Description**

Quantity/Description	Beta N.	TR
16 combination wrenches 6÷21 mm	42	M05
5 combination wrenches 22 - 24 - 27 - 30 - 32 mm	42	M06
1 slip joint pliers boxed joints 250 mm	1048	M153
1 self - locking pliers 240 mm	1052	M153
8 offset hexagon key wrenches $\odot$ 2-2,5-3-4-5-6-7-8 mm	96T	M50
5 drivers for Torx® head screws, with handles $\odot$ T10-T15-T20-T25-T30	97TTX	M55
1 adjustable wrench 250 mm	111	M292
1 electrician's scissors, straight blades	1128BMX	M292
1 measuring tape 5 m	1692/5	M292
1 snap - off blade utility knife 170 mm	1771	M292
5 screwdrivers for cross head Phillips® screws $\bullet$ 3x75 - 3,5x100 - 4x125 - 5,5x150 - 6,5x150 mm	1260	M208
3 screwdrivers for cross head Phillips® screws $\oplus$ PH0x60 - PH1x80 - PH2x100 mm	1262	M208
1 screwdrivers for slotted head screws, extra-short series $\bullet$ 4x30 mm	1260N	M208
1 screwdrivers for cross head Phillips® screws, extra - short series $\oplus$ PH1x30 mm	1262N	M208
5 bits for slotted head screws, coloured $\bullet$ 0,5x3 - 0,6x4,5 - 0,8x5,5 - 1x5,5 - 1,2x6,5 mm	860LP	M85
8 hexagon bits for power drivers, coloured $\odot$ 2 - 2,5 - 3 - 4 - 5 - 6 - 8 - 10 mm	860PE	M85
5 bits for cross head Phillips® screws, coloured $\oplus$ PH0 - PH1 - PH2 - PH3 - PH4	860PH	M85
4 bits for cross head Pozidriv® - Supadriv® screws, coloured	860PZ	M85
11 bits for Torx® head screws, coloured $\odot$ T6-T7-T8-T9-T10-T15-T20-T25-T27-T30-T40	860TX	M85
8 bits for Tamper Resistant Torx® head screws, coloured $\oplus$ T9-T10-T15-T20-T25-T27-T30-T40	860RTX	M85
1 magnetic bit holder with handle 230 mm	851SR	M85
1 reversible bit ratchet 100 mm	860/55	M85
1 magnetic bit holder extension bar 80 mm	882P	M85
1 adaptors for drivers $\blacksquare$ 1/4 - $\square$ 1/4	892	M85
2 flat chisels, ribbed type 100 - 200 mm	35	M234
1 engineer's hammer 300 g	1370	M234
1 soft face hammer $\varnothing$ 35 mm	1390	M234
1 1/2" wobble extension bar 125 mm	920AN	M83
1 1/2" wobble extension bar 250 mm	920AN	M83
1 1/2" drive universal joint	920/25	M83
1 1/2" drive sliding T-handle	920/42	M83
1 1/2" drive reversible ratchet $\oplus$	920/55	M83
19 1/2" square drive hexagon sockets $\odot$ 10÷24-26-27-30-32 mm	920A	M83
1 diagonal cutting nippers $\nless$ 160 mm	1082GBM	M134
1 combination pliers $\equiv$ 180 mm	1150GBM	M134
1 extra long needle knurled nose pliers $\bullet$ 160 mm	1166GBM	M134
1 circlip pliers straight, internal $\odot$ 180 mm	1032	M145
1 circlip pliers bent, internal $\odot$ 170 mm	1034	M145
1 circlip pliers straight, external $\bullet$ 175 mm	1036	M145
1 circlip pliers bent, external $\bullet$ 175 mm	1038	M145

024500001 **M01**  
 € 315,00 € 262,00

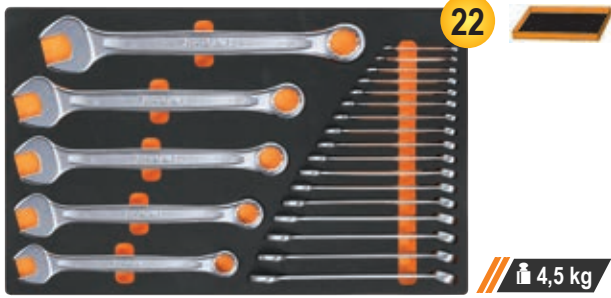

22

4,5 kg

42 6-7-8-9-10-11-12-13-14-15-16-17-18  
 19-20-21-22-24-27-30-32-36 mm



024500030 **M30**  
 € 262,00 € 215,50



31

4,2 kg

55 6x7-8x9-10x11-12x13-14x15-16x17-18x19-20x22-21x23-24x27-30x32 mm  
 90 6x7-8x9-10x11-12x13-14x15-16x17-18x19-20x22-21x23-24x27-30x32 mm  
 96BPC/SC9 1,5-2-2,5-3-4-5-6-8-10 mm

024500044 **M44**  
 € 188,00 € 151,50



12

141 8-9-10-11-12  
 13-14-15-16  
 17-18-19 mm

1,3 kg

024500060 **M60**  
 € 245,50 € 200,50



23

1,9 kg

○ 96T 2-2,5-3-4-5-6-7-8-10 mm  
 ○ 97BTX/SC8 T9-T10-T15-T20-T25-T27-T30-T40 mm  
 ○ 944BX 5-6-7-8-10-13 mm

024500063 **M63**  
 € 262,00 € 211,00



8

3,4 kg

○ 952 7-8-10-12-13-14-17-19 mm

024500100 **M100** 14" 12"  
 € 721,00 € 566,00



98

6,7 kg

895/1 - 895/3 - 895/6  
 ○ 900 4-4,5-5-5,5-6-7-8-9-10-11-12-13-14 mm  
 ○ 900L 5-6-7-8-9-10-11-12-13 mm  
 ○ 900ME 3-4-5-6-7 mm  
 ● 900LP 0,8x4-1x5,5-1,2x6,5-1,2x8 mm  
 ⊕ 900PH PH1-PH2-PH3-PH4  
 ○ 900TX T10-T15-T20-T25-T27-T30-T40  
 900/20 50 mm - 900/20L 100 mm  
 900/21 150 mm  
 900/25 - 900BG/30 - 900/42

⊕ 900/55  
 ○ 920A 8-10-11-12-13-14-15-16-17-18-19-20-21-22-23-24-26-27-28-30-32 mm  
 920/15 - 920/25  
 920AN/125 125 mm  
 920AN/250 250 mm  
 920/42  
 ⊕ 920/55  
 ⊕ 920FTX 10-12-14-16-18-20-22-24 mm  
 ○ 920AL 10-12-13-14-15-16-17-18-19-21-22 mm

**024500871 M105 14" 3/8" 12"**  
 € 786,00 € 627,00



116

7,7 kg

- 900 4-4,5-5-5,5-6-7-8-9-10  
11-12-13-14 mm
- 900L 5-6-7-8-9-10-11-12-13 mm
- 96BPC/SC9 1,5-2-2,5-3-4-5-6-8-10 mm  
895/1 - 895/3 - 895/6
- 900ME 3-4-5-6-7 mm
- 900LP 0,8x4-1x5,5-1,2x6,5-2x8 mm
- ⊕ 900PH PH1-PH2-PH3-PH4
- ⊖ 900TX T10-T15-T20-T25-T27-T30-T40
- 900/16 □ 1/4 - ■ 3/8
- 900/... 50-100-150 mm
- 900/25 - 900BG/30 - 900/42
- ⊕ 900/55
- 910A 6-7-8-9-10-11-12-13-14-15-16-  
17-18-19-20-21-22 mm
- 910/15 □ 3/8 - ■ 1/4
- 910/16 □ 3/8 - ■ 1/2
- 910/21 125 mm
- 910/22 250 mm
- 910/25 - 910/42
- ⊕ 910/55
- 920A 8-10-11-12-13-14-15-16-17  
18-19-20-21-22-23-24-26  
27-28-30-32 mm
- 920/15 □ 1/2 - ■ 3/8
- 920/25 125 - 250 mm
- 920AN 125 - 250 mm
- 920/42
- ⊕ 920/55
- 956E 16-17,8-20,8 mm

**024500115 M115 12"**  
 € 724,00 € 573,00



54

7,8 kg

- ⊕ 666N 40÷200 Nm
- 920A 13-14-15-16-17-18-19-20-21-22-24-  
26-27-30-32 mm
- 920FTX 12-14-16-18-20-22-24 mm
- 920PE 6-7-8-8L-10-10L-12-12L-14-14L
- 920TX T20-T25-T27-T30-T40-T45-T50-  
T55-T60-T20L-T25L-T27L-T30L-  
T40L-T45L-T50L
- 920/21 125 mm
- 920/22 255 mm
- 920/25
- 920/42 305 mm
- ⊕ 920/55

**024500120 M120 12"**  
 € 772,00 € 592,00



75

6,9 kg

- 920A 10-11-12-13-14-15-16-17-18-  
19-20-21-22-24-26-27-30-32 mm
- 920AN/125 125 mm
- 920AN/250 250 mm
- 920/25 - 920/42
- 920AL 10-12-13-14-15-16-17-18-19-22-24-27-30-32 mm
- ⊖ 920FTX 10-12-14-16-18-20-22-24 mm
- ⊕ 920/55
- 920PE 5-5L-6-6L-7-7L-8-8L-10-10L-12-12L-14-14L
- 920TX T20-T25-T27-T30-T40-T45-T50-T55-T60-  
T20L-T25L-T27L-T30L-T40L-T45L-T50L

**024500128 M128 12"**  
 € 574,00 € 445,00



50

8,9 kg

- 720 10-11-12-13-14-15-16-17-18-19-21-22-24-27-30-32 mm
- 720L 11-12-13-14-15-16-17-18-19-21-22-24-27-30-32 mm
- ⊖ 720TX T30-T40-T45-T50-T55
- 720ME 5-6-8-10-12-14-17-19 mm
- 720LC 17-19-21 mm
- 720/21 125 mm
- 720/25

**024500129 M129**  
 € 277,00 € 234,00



13

3,4 kg

- 1032 180 mm
- 1034 170 mm
- 1036 175 mm
- 1038 175 mm
- 1048 250 mm
- 1052 240 mm
- ⊚ 1082BM 160 mm
- 1098 220 mm
- 1112 250 mm
- 1128BM
- ≡ 1150BM 180 mm
- 1166BM 160 mm
- 1168BM 160 mm

**024500133 M133**  
 € 54,50 € 46,00



3

650 g

- ⊚ 1082G 160 mm
- ≡ 1150G 180 mm
- 1166G 160 mm

**024500134 M134**  
 € 69,50 € 59,50



3

750 g

- ⊚ 1082GBM 160 mm
- ≡ 1150GBM 180 mm
- 1166GBM 160 mm



024500162 **M162**  
€90,50 €75,50



8

- 1241 5,5x100-6,5x125-8x150-10x200 mm
- 1242 PH1x100-PH2x100-PH3x150-PH4x200 mm

1,4 kg

024500195 **M195**  
€191,50 €155,00



25

- 1260 2,5x50-3x75-4x100-5,5x125-6,5x150-8x200 mm
- 1260N 4x30 mm
- 1262 PH0x60-PH1x80-PH2x100-PH3x150 mm
- 1262 PH1X30 mm
- 1267TX T6-T7-T8-T9-T10-T15-T20-T25-T27-T30-T40-T45
- 1253 3,5x100 mm

2,3 kg

024500213 **M213**  
€123,50 €104,00



25

- 1201E 2,5x50-3x75-4x100-5,5x125-6,5x150-8x200 mm
- 1201EN 4x30 mm
- 1202E PH0x60-PH1x80-PH2x100-PH3x150 mm
- 1202EN PH1X30 mm
- 1207E/TX T6-T7-T8-T9-T10-T15-T20-T25-T27-T30-T40-T45
- 1253

1,8 kg

024500230 **M230**  
€285,00 €235,00



25

- 30 Ø 2-3-4 mm
- 31 Ø 2-3-4-5-6-8 mm
- 32 Ø 4 mm
- 34 150 mm
- 35 200-250 mm
- 36 125 mm
- 1370 500 g
- 1390 Ø 35 mm
- 1692 3 m
- 1712
- 1719BMA/Q 200 mm
- ▲ 1719BMA/T 200 mm
- 1719BMA/P 200 mm
- 1719BMA/M 200 mm
- 1719BMA/R 200 mm
- 1737
- 1771 18 mm

3,2 kg

024240001 **T01**  
€195,00 €163,00

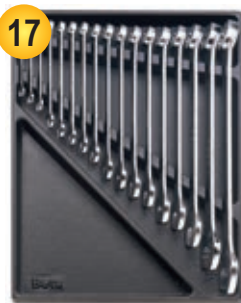

17

- 42 6-7-8-10-11-12-13-14-16-17-18-19-21-22-24-27-30 mm

2,7 kg

024240005 **T05**  
€149,50 €124,00



16

- 42 6-7-8-9-10-11-12-13-14-15-16-17-18-19-20-21 mm

1,5 kg

024240006 **T06**  
€181,50 €87,00



5

- 42 22-24-27-30-32 mm

2,1 kg

024240031 **T31**  
€155,50 €125,00



27

- 31 Ø 2-3-4-5-6 mm 32 Ø 4 mm
- 55 6x7-8x9-10x11-12x13-14x15-16x17-18x19
- 20x22-21x23-24x26-27x29-30x32 mm
- Ø96N/SC9 1,5÷10 mm

3 kg

024240040 **T40**  
€58,00 €48,50



7

- 90 6x7-8x9-10x11-12x13-14x15-16x17-18x19 mm

810 g

024240045 **T45**  
€208,50 €164,00



12

- 142 8-9-10-11-12-13-14-15-16-17-18-19 mm

1,3 kg

024240050 **T50**  
€105,50 €89,00



11

- 96T 2-2,5-3-3,5-4-4,5-5-6-7-8-10 mm

1,3 kg

024240055 **T55**  
€53,00 €46,50



6

- 97TTX T10-T15-T20-T25-T27-T30

330 g

**024240063 T63**  
~~€ 265,00~~ € 205,00

**8**

952 7-8-10-12-13-14-17-19 mm

**3,8 kg**

**024240083 T83**  
~~€ 189,50~~ € 157,50

**24**

12"

920A 10-11-12-13-14-15-16-17-18-19-20-21-22-23-24-26-27-30-32 mm  
 920/21 125 mm 920/42 305 mm  
 920/22 255 mm 920/55 275 mm  
 920/25

**3,6 kg**

**024240091 T91**  
~~€ 135,00~~ € 108,50

**25**

14"

900 4-4,5-5-5,5-6-7-8-9-10-11-12-13-14 mm  
 900ME 2,5-3-4-5-6-8 mm  
 900/20 50 mm  
 900/21 150 mm  
 900/25

**560 g**

**024240092 T92**  
~~€ 158,00~~ € 129,00

**22**

38"

910A 6-7-8-9-10-11-12-13-14-15-16-17-18-19-20-21-22 mm  
 910/21 125 mm 910/42 210 mm  
 910/22 250 mm 910/55 200 mm  
 910/25

**1,5 kg**

**024240124 T124**  
~~€ 66,00~~ € 55,50

**3**

**640 g**

1082GBM 160 mm  
 1150GBM 180 mm  
 1166GBM 160 mm

**NEW**

**024240137 T137**  
~~€ 75,50~~ € 63,00

**3**

**750 g**

1084BM 160 mm  
 1150BM 180 mm  
 1166BM 160 mm

**024240145 T145**  
~~€ 76,50~~ € 64,00

**4**

**640 g**

1032 180 mm  
 1034 170 mm  
 1036 175 mm  
 1038 175 mm

**024240153 T153**  
~~€ 43,00~~ € 36,50

**2**

**1,1 kg**

1048 250 mm  
 1052 240 mm

**024240199 T199**  
~~€ 39,50~~ € 32,00

**7**

**490 g**

1260 2,5x50 - 3x75 - 3,5x100 - 4x125 - 5,5x100 - 5,5x150 - 6,5x150 mm

**024240202 T202**  
~~€ 37,00~~ € 29,50

**6**

**490 g**

1262 PH0x60 - PH0x100 - PH1x80 - PH1x120 - PH2x100 - PH2x150 mm

**024240205 T205**  
~~€ 39,00~~ € 31,50

**7**

**460 g**

1267TX T6-T7-T8-T9-T10-T15-T20

**024240211 T211**  
~~€ 27,50~~ € 21,80

**7**

**490 g**

1201E 2,5x50-3x75-3,5x100 - 4x125-5,5x100-5,5x150-6,5x150 mm

**024240213 T213**  
~~€ 29,00~~ € 23,20

**6**

**490 g**

1202E PH0x60-PH1x80 - PH1x120-PH2x100 - PH2x150-PH3x150 mm

**024240234 T234**  
~~€ 69,50~~ € 57,50

**4**

**1,3 kg**

35 100-200 mm  
 1370 300 g  
 1390 ø 35 mm

**024240236 T236**  
~~€ 64,50~~ € 53,00

**5**

**870 g**

1719BMA/Q 200 mm  
 1719BMA/T 200 mm  
 1719BMA/P 200 mm  
 1719BMA/M 200 mm  
 1719BMA/R 200 mm

**024240239 T239**  
~~€ 98,50~~ € 81,50

**7**

**850 g**

31BM ø 2-3-4-5-6-8 mm  
 32 ø 4 mm

# COMBO

## COMBO IS BETA'S MODULAR SYSTEM

The tool cases can be easily joined to each other by a simple click, through the functional side snap-on mechanism. The tool cases can be combined as you like, depending on your requirements.

### COMBO ABS tool case, with transparent cover

Main features:

- Transparent cover made from sturdy polycarbonate for quick identification of contents
- Interior dimensions: 378x313x61 mm
- Can be padlocked

### 099000200 C99V0-P12

€ 117,50 **€ 95,00**

- Particularly suitable for carrying smallwares, including screws, nuts, washers, rivets and dowels
- Supplied complete with kit of 18 tote trays:
  - 2 red trays, 52x52 mm
  - 3 yellow trays, 104x52 mm
  - 2 blue trays, 104x104 mm
  - 1 green tray, 104x156 mm
  - 2 orange trays, 208x52 mm
  - 2 grey trays, 312x71 mm, and 6 adjustable partitions

kg  
25



kg  
3,2

445x358x118 mm

### 099000202 C99V0

€ 83,00 **€ 67,00**

445x358x118 mm



kg  
2,5

**NEW**

### 099000010 C99

€ 479,00 **€ 388,00**

#### BETA COMBO comprehensive modular system

System comprising:

- Aluminium folding tool trolley with telescopic handle C99P (485x520x1195 mm)
- ABS wall tool case C99V1 (445x358x152 mm)
- ABS wall tool case C99V2 (445x358x254 mm)
- ABS wall tool case with 2 portable tote trays C99V3/2C (445x358x322 mm)

### 099000250 C99V1

€ 84,50 **€ 68,00**

#### Wall tool case, made from ABS, empty

Main features:

- Inner dimensions: 383x320x103
- Max. interior carrying capacity: 25 kg
- Can be padlocked

kg  
25



445x358x152 mm

kg  
2,2

### 099000350 C99V2

€ 94,50 **€ 76,50**

#### Wall tool case, made from ABS, empty

Main features:

- Inner dimensions: 389x320x205
- Max. interior carrying capacity: 25 kg

kg  
25



445x358x254 mm

kg  
2,8

### 099000450 C99V3/2C

€ 177,50 **€ 143,50**

#### Wall tool case, made from ABS, with 2 portable tote trays

Main features:

- Inner dimensions: 395x320x100
- Supplied with 2 tote trays C99C-V3, empty

kg  
25



kg  
5,6

445x358x322 mm

### 099000101 C99P

€ 122,50 **€ 99,00**

#### Folding tool trolley, made of aluminium

Main features:

- Ultracompact folding tool trolley, made of anodized aluminium
- Telescopic handle
- Dimensions when open: 485x520x1195 mm
- Dimensions when closed: 485x60x905 mm
- Dimensions of folding base: 485x350 mm
- Two puncture proof wheels, Ø 175 mm
- Supplied with strap

kg  
100

1095 mm  
320 mm  
485 mm



kg  
5,8



059900001 **5990V1**  
 € 419,00 **€ 339,00**



**ASSORTMENT OF 44 TOOLS FOR TOOL CASE COMBO C99V1,**  
 in EVA foam tray

38/B6N

**COMBO**  
 Assortment recommended in combination with Beta Combo C99

Quantity/Description

Beta N.

- 9 ball head offset hexagon key wrenches  $\bigcirc$  1,5-2-2,5-3-4-5-6-8-10 mm 96BPC/SC9
- 1 snap - off blade utility knife 18 mm 1771
- 1 Slip joint pliers boxed joints 250 mm 1048
- 6 2 drift punches, 1 centre punch, 3 flat chisels with metal holder 38/B6
- 3 screwdrivers for slotted head screws  $\bullet$  3,5x100-5,5x125-6,5x150 mm 1260
- 3 screwdrivers for cross head Phillips® screws  $\oplus$  PH0x60-PH1x80-PH2x100 mm 1262
- 1 electrician's scissors, straight blades 1128BMX
- 16 combination wrenches 6-7-8-9-10-11-12-13-14-15-16-17-18-19-21-22 mm 42NEW
- 1 measuring tape 5 mt 1692/5
- 1 engineer's hammer 300 g 1370
- 1 Diagonal cutting nippers, bi-material handles, industrial finish  $\nabla$  160 mm 1082GBM
- 1 heavy duty combination pliers, bi-material handles, industrial finish  $\equiv$  180 mm 1150GBM



Assortment recommended in combination with C99V1



059900003 **5990V3** 14" 12"  
 € 536,00 **€ 435,00**

**ASSORTMENT OF 116 TOOLS FOR TOOL CASE COMBO C99V3/2C,**  
 in EVA foam tray

Quantity/Description

Beta N.

- 5 offset hexagon key wrenches  $\bigcirc$  2,5-3-4-5-6 mm 96T/S5P
- 1 adjustable wrench 250 mm 111
- 1 1/4" drive spinner handle 900BG/30
- 1 mains testing screwdriver  $\bullet$  1253
- 1 Pocket spirit level with magnetic V-shaped 1695XS
- 1 LED inspection torch, made of sturdy anodized aluminium 1833XS/2
- 31 bits with magnetic quick release bit holder in plastic case  $\bullet$   $\bigcirc$   $\oplus$   $\otimes$   $\otimes$  860MIX/A31
- 1 socket holder 895
- 12 1/4" hexagon sockets  $\bigcirc$  4-4,5-5-5,5-6-7-8-9-10-11-12-13 mm 900
- 1 1/4" drive extension bar 50 mm 900/20
- 1 1/4" drive extension bar 100 mm 900/20L
- 1 1/4" drive swivel T-handle 900/42
- 1 1/4" drive reversible ratchet, 72 tooth mechanism  $\otimes$  900/55Z
- 38 microscrewdriver with 36 interchangeable 4-mm bits and magnetic extension 1256/C36-2
- 1 soft face hammer  $\emptyset$  35mm 1390
- 1 1/4" drive universal joint 900/25
- 13 1/2" square drive hexagon sockets  $\bigcirc$  10-11-12-13-14-15-16-17-18-19-20-21-22 mm 920A
- 1 1/2" drive extension bar 125 mm 920/21
- 1 1/2" drive extension bar 255 mm 920/22
- 1 1/2" drive universal joint 920/25
- 1 1/2" drive sliding T-handle 920/42
- 1 1/2" drive reversible ratchet  $\otimes$  920/55



Assortment recommended in combination with C99V3/2C

**NEW**

# NEW Beta BRUTUS

048000230 **C48M**  
€ 2.175,00 € 1.745,00



### Electric platform cart, with panels

- Motorized platform, with 24V - 400W motor with 2x12V 33Ah battery supply and Curtis control card.
- Loading floor made from sturdy steel, coated with non-slip rubber, with round tubular panels preventing objects from falling during transport.
- The panels can be removed, to cater to individual transportation requirements.
- Fitted with 2 pneumatic traction wheels (Ø 260 mm) and 2 swivelling rubber wheels (Ø 150mm), electromagnetic brake and differential gear.
- Supplied with an external battery charger, 220V/50Hz - V/A 24/12e.



400



The control console is equipped with the following:

- ① ignition key
- ② speed adjusting knob
- ③ side butterfly handles for traction control
- ④ intermittent beep, which is activated when moving in reverse
- ⑤ battery charge indicator
- ⑥ electric brake cut-out button
- ⑦ emergency mushroom head button.

**GO AROUND AS LONG AS YOU LIKE!  
UP TO 4 HOURS BATTERY LIFE**



140 kg

**SPEED ADJUSTABLE  
FROM 4 TO 6 KM/H**

### FUNCTIONAL SPECIFICATIONS

- Carrying capacity: **400 kg**
- Driving speed: **4-6 km/h** (adjustable)
- Battery life: **4 hours**
- Maximum permitted slope with a full load: **6%**
- Maximum permitted slope with 100 kg load: **18%**

### SAFETY DEVICES:

- Electronic brake
- Buzzer
- Anti-crushing guard
- Battery charge indicator
- Curtis control cart

### TECHNICAL SPECIFICATIONS

- Overall dimensions: 1280x630x1100h mm
- Useful dimensions of loading platform with panels: 1180x580 mm
- Useful dimensions of loading platform without panels: 1260x620 mm
- Height of loading platform from floor: 320 mm
- Height of battery compartment from floor: 65 mm
- Weight with batteries: 140 kg

048000030 **C48P**

€ 180,50 € 145,50

### Folding tool trolley

- Loading platform made of reinforced polypropylene (PP), with non-slip coating and TPV inserts for corner protection
- Retractable handle for quick, compact storage
- Four non-marking castors, Ø 125 mm: 2 fixed and 2 steering with brakes
- Maximum capacity: 300 kg.
- Loading platform working width: 705 mm
- Loading platform depth: 480 mm
- Loading platform height: 200 mm



300



11 kg



# //C56B

## WORKBENCH WITH WOOD TOP

Main features:

- Multi-ply wood worktop with holes for a vice (1599F/125, to be ordered separately)
- Steel frame with 4 supporting legs
- Lower object shelf
- Can be fixed to floor



Ral 2011	Ral 7016	Ral 3000
056000401	056000402	056000403

// € 585,00 **€ 393,00**

KG  
600



930 mm  
720 mm  
2000 mm

// 54,5 kg

# //C59A

## WORKBENCH WITH 1 CAB WITH SIX DRAWERS

Main features:

- Worktop made from multi-ply wood with holes for vice item 1599F/125 (to be ordered separately)
- 6 drawers (588x367 mm) with ball bearing slides
- Drawers protected by foamed rubber mats
- Hard-wearing nylon drawer front
- Roller cabs can accommodate thermoformed trays
- Front centralized safety lock
- Lower object shelf
- Can be fitted with paper roll holder (2400S-R/PC) and bottle holder (2400S/PF), to be ordered separately



Ral 2011	Ral 7016	Ral 3000
059000001	059000021	059000041

// € 1.139,00 **€ 957,00**

KG  
1500



931 mm  
700 mm  
2000 mm

// 115 kg



n°		↓ max
4	70 mm	25 kg
1	140 mm	30 kg
1	280 mm	35 kg

# //C56

## WORKBENCH

- Worktop made of painted sheet metal with external edge
- Steel frame with 6 supporting legs
- Two drawers with lock
- Can be fixed to floor



Ral 2011	Ral 7016	Ral 3000
056000201	056000202	056000203

// € 669,00 **€ 564,00**

KG  
1200



930 mm  
640 mm  
2000 mm

// 82 kg

056000021 **C56PL 0**  
~~€ 278,00~~ **€ 227,50**

## FOLDING WORKBENCH LIGHTWEIGHT RELIABLE

- Lightweight, easy to carry.
- Worktop (800x500mm) made of galvanized sheet iron, for use on one side, protected by an anti-oil and anti-petrol rubber cover.
- Handle with rubber cover, for easy transportation.
- An additional sturdy, reliable worktop, always within reach



kg  
200



**EVEN LIGHTER!  
ONLY 18.5 KG**

860 mm  
500 mm  
910 mm

kg  
18,5



## //C51

### TROLLEY

- 3 tops covered in antislip ribbed rubber
- Two fixing options for central worktop
- Four castors Ø 100 mm:  
2 fixed and 2 steering (1 with brake)

kg  
200



kg  
21

900 mm  
450 mm  
800 mm



Ral 2011	Ral 7016	Ral 3000
051000001	051000002	051000003

~~€ 211,50~~ **€ 170,00**

## //C27S

### FOLDING TOOL TROLLEY FOR OUTDOOR JOBS, EMPTY

- Folding tool trolley. Its unique patented design guarantees an effortless transport
- 2 drawers, 588x277 mm, with ball bearing slides, for two-way opening
- Large lower object compartment, 588x277x220 mm
- Sheet metal frame
- 2 fixed castors, Ø 160 mm, and 2 steering castors with brake, Ø 100 mm
- Thermoplastic worktop with 6 built-in tool trays
- Centralized lock
- Can accommodate drawer partitions and MC foam tool trays



570 mm



995 mm

kg  
20

995 mm  
395 mm  
765 mm

n°	h	↓ max
2	70 mm	20 kg

~~€ 528,00~~ **€ 425,00**

Ral 2011	Ral 7016	Ral 3000
027000201	027000202	027000203

# //C41H

## TWO-MODULE TOOL TROLLEY

Main features:

- Sheet metal frame and plastic tops, synonymous with remarkable sturdiness and reduced weight
- 2 detachable modules:
  - 1 upper tool box,
  - 1 module with 2 drawers 95 mm in height, 1 pull-out case made of plastic, 66 mm high, and 1 drawer 295 mm in height
- Oversized castors (160 mm), built into frame for easy transport - for example, on steps
- Side centralized lock for closing drawers of lower module
- Drawers with ball bearing slides and double closing hook
- Telescopic aluminium handle
- Small tool holder built into upper tool box
- Lower drawer with double ballbearing slide

- |   |           |   |           |
|---|-----------|---|-----------|
|  | 041000002 |  | 041000021 |
|  | 041000024 |  | 041000006 |
|  | 041000012 |  | 041000008 |
|  | 041000010 |  | 041000005 |

€ 452,00 **€ 360,00**



## // 021200002 C20L

€ 57,50 **€ 46,50**

Five-section cantilever tool box, made from sheet metal, empty



550x200x210 mm

**5,4 kg**

## // 021170500 CP17

€ 68,00 **€ 54,50**

Tool box, made of stainless steel and plastic, removable tote-tray, empty



500x200x220 mm

**2,5 kg**



## // 021203001 C20TSS

€ 189,00 **€ 151,00**

Five-section cantilever tool box, made of AISI 304 stainless steel

can be used in critical environments - that is, in areas where the minimum contamination level is not permitted -, is resistant to rust and the main acids, and can be autoclave sterilized at 121 °C.



**4 kg**

450x200x210 mm

## // 021150201 CP15

€ 35,00 **€ 28,00**

Tool box, made from plastic, removable tote-tray and tool trays, empty

- 2 removable tool trays built into cover with adjustable partitions
- 1 interior tote-tray with adjustable partitions
- Carrying capacity: 30 kg



445x240x250 mm

**2,5 kg**





# TOOL BAGS

Beta

020330250 **2033L/VV**  
~~€ 254,00~~ **€ 205,00**

**Tool case, made from aluminium, empty**

- Highly shock resistant
- Nonscratch finish
- Ergonomic handle with rubber grip
- Double closure with combination
- 2 tool panels with elastic bands
- Interior bottom with removable partitions



**NEW**

470x375x205 mm

4,8 kg

020800100 **2080/VG**  
~~€ 122,00~~ **€ 96,00**

**ABS organizer tool case with swivel trays**

- With upper small parts organizer (145 mm in diameter) and 4 swivel trays:
  - 1 tray 305 mm in diameter
  - 3 trays 445 mm in diameter
- Supplied complete with 12 partitions for use in 3 larger swivel trays, to obtain up to 8 compartments per level



550 mm

445 mm

3,4 kg

**NEW**

020800000 **2080/V12**  
~~€ 42,00~~ **€ 34,00**

**Organizer tool case with 12 removable tote-trays**

Removable, folding clear tote-trays, for immediate recognition of contents



300x330x145 mm 1,8 kg

020380000 **2038/TV**  
~~€ 654,00~~ **€ 525,00**

**Tool trolley, made of thick polypropylene, empty**

- Highly shock resistant
- Aluminium sealing profile
- Telescopic handle and big ball bearing castors
- Capacious bottom
- Document pocket
- 3 tote drawers



2 TSA approved locks with keys



2 ergonomic rubber-coated handles (including 1 side handle)



9 kg

430x500x340 mm

2 removable tool panels

020290000 **2029/VV**  
~~€ 241,00~~ **€ 194,00**

**Tool case, made of thick polypropylene, aluminium edged, empty**

- 2 interior tool panels



490x380x230 mm

6,1 kg



021030000 **C3**  
~~€ 48,00~~ **€ 38,50**

**Mini tool bag,**  
 made from technical fabric  
 Main features:

- 1 exterior front pocket with zip closure
- 2 side pockets with tote trays
- 1 convenient rear pocket with Velcro closure
- 1 removable interior tool panel, with elastic bands on both sides
- Complete with shoulder strap



330x320x150 mm

890 g



**A MINI TOOL BAG  
 TO ALWAYS  
 BRING WITH YOU!**

**NEW**



USB interface for charging mobile devices



021050000 **C5**  
~~€ 114,50~~ **€ 92,00**

**Rucksack, empty**

- Removable interior tool panel
- Six exterior pockets and two interior pockets
- Waterproof plastic base
- Double safety lace for fixing rucksack to shoulders
- Ergonomic padded back



2,5 kg

500x400x180 mm

021050100 **C5S**  
~~€ 42,50~~ **€ 34,00**

**Tool rucksack, made of hard-wearing polyester**

- Double handle on top centre of rucksack for firm, balanced hold
- Two large front pockets
- Two capacious interior pockets
- 2 Velcro tool straps
- Handy roll-up interior bag, composed of 4 tool panels
- Adjustable reinforced shoulder straps
- Maximum carrying capacity



370x300x100 mm

900 g



021060010 **C6T**  
~~€ 168,00~~ **€ 131,00**

**Rucksack with castors, empty**

- Telescopic handle for easy transport
- Built-in castors with practical dustproof cover for use as a rucksack
- Two removable tool panels
- Interior PC pocket and five exterior pockets
- Waterproof plastic base



480x370x220 mm

4,5 kg

021110000 **C11**  
~~€ 68,00~~ **€ 54,50**

**Technical fabric tool box**

- Hard water resistant plastic base
- Elastic tool bands and interior and exterior tool pockets
- Document holders built into double bottom of cover



**2 kg**

400x240x220 mm

021100001 **C10S**  
~~€ 91,00~~ **€ 72,50**

420x220x250 mm

**2,3 kg**

**Box, empty**

- Hard frame
- Double bottom.
- Tilting handle for easier access to tools
- Elastic tool bands and interior and exterior pockets
- Cover
- Tool tray included in double bottom
- Can be used with trolley C8

021100000 **C10**  
~~€ 117,50~~ **€ 94,00**

520x220x250 mm

**3,3 kg**



020010151 **2001/BZV**  
~~€ 32,50~~ **€ 27,00**

**Tool case**  
 made from durable technical fabric

- Double upper handle for optimal hold
- Large front document pocket with zip closure
- 20 convenient tool compartments (6 pockets and 14 elastic bands)
- Hammer loops
- Shoulder strap C9/RT can also be included (to be ordered separately)



380x290x60 mm

**675 g**

**NEW**

020010157 **2001/BZ27 VU**  
~~€ 187,00~~ **€ 150,50**

**Folding tool case with assortment of 27 tools, for universal use**



**Quantity/Description**

Quantity/Description	Beta N.
1 electrician's scissors, straight blades	1128BMX
1 half-round needle nose pliers = 180 mm	1150
6 combination wrenches 7-8-10-13-17-19 mm	42
3 screwdriver for slotted head screws 3x75 - 4x100 - 5,5x150 mm	1201E
3 screwdriver for cross head Phillips® screws	1202E
⊕ PH0x60 - PH1x80 - PH2x100 mm	
9 offset hexagon key wrenches ○ 1,5-2-2,5-3-4-5-6-8-10 mm	96/SC9
1 engineer's hammer 300 g	1370
1 Slip joint pliers boxed joints 250 mm	1048
1 measuring tape 5 m	1692/5
1 snap - off blade utility knife 18 mm	1771

**NEW**



020050030 **2005PA/E**  
~~€ 33,00~~ **€ 26,00**

- Tool pouch, empty, made from nylon, with belt**
- Two large pockets with elastic tool bands
  - Two front scissors pockets
  - Two convenient side compartments with:
    - left pocket with sturdy metal hook for measuring tapes
    - double right pocket with bag with drawstring and zip closure
  - Buckle with carabine hook for adhesive tape
  - Adjustable belt (70 ÷ 120 cm)



≡ 260x250x190 mm

020050035 **2005PA/ET**  
~~€ 122,50~~ **€ 99,00**

**1000 V**  
**Tool pouch with assortment of 8 tools for electrotechnical maintenance**

020050040 **2005PA/U**  
~~€ 115,50~~ **€ 93,00**

**Tool pouch with assortment of 17 tools for universal use**



**Quantity/Description**

- |  |         |
|--|---------|
| 1 diagonal cutting nippers 1000V $\nabla$ 160 mm | 1082MQ  |
| 1 electrician's scissors, straight blades        | 1128BMX |
| 1 mains testing screwdriver $\bullet$            | 1253    |
| 2 PH1x80 - PH2x100                               | 1272MQF |
| 2 3,5x100 - 4,5x100                              | 1274MQF |
| 1 PVC electrical tape                            | 1639ESB |

**Quantity/Description**

- |   |                |
|---|----------------|
| 9 offset hexagon key wrenches                                     | Beta N. 96/SC9 |
| 1 adjustable wrench 200 mm  | 111            |
| 1 Slip joint pliers boxed joints 250 mm                           | 1048           |
| 1 electrician's scissors, straight blades                         | 1128BMX        |
| 2 screwdriver for slotted head screws 4x100 - 5,5x125 mm          | 1201E          |
| 2 screwdriver for cross head Phillips® screws PH1x80 - PH2x100 mm | 1202E          |
| 1 measuring tape 3 m  | 1692           |

020050060 **2005MPU**  
~~€ 21,30~~ **€ 16,60**

**Tool pouch, empty, made from nylon, with belt**

- Five large tool pockets
- One front scissors pocket
- Buckle with carabine hook for adhesive tape
- Adjustable belt (70 ÷ 120 cm)



≡ 155x285x80 mm

020050065 **2005MPU/E**  
~~€ 66,00~~ **€ 53,00**

**Tool pouch with assortment of 5 tools**



- |  |  |
|--|--|
| 1 electrician's scissors, straight blades                          |  |
| 1 half-round needle nose pliers $\equiv$ 180 mm                    |  |
| 2 screwdriver for slotted head screws $\bullet$ 3,5x100 - 4x100 mm |  |
| 1 screwdriver for cross head Phillips® screws $\bullet$ PH1x80 mm  |  |



- Beta N.**  
 1128BMX  
 1150BM  
 1201E  
 1202E

# 42

## Our epoch-making wrench 42 has a new shape.

A stylish, slim shape enhanced by a slender profile, lighter to the touch.

The strength, resilience and ergonomic design of the Beta wrench reach even higher values, to provide users with the best possible tool. The manufacturing process is carried out in our factories in Sovico and Sulmona, on the basis of state-of-the-art automation technology and the best trained workers.

### POWERFUL

Torque values more than doubled compared to the requirements to be satisfied under ISO 1711.



### ERGONOMIC

The offset ring has a 15 degree angle to protect the hand. The shape is obtained from a die; it is not bent later.

Remarkable strength: in case of improper use, the wrench buckles, without breaking suddenly and dangerously.

### CAUTION!

The new shape of wrench 42 is perfectly compatible with all the containers and trays of our epoch-making wrench 42



000421078 **42/SP15**  
~~€ 137,50~~ **€ 110,50**

**Set of 15 combination wrenches**

- with holder

6-7-8-9-10-11-12-13-14-15-16-17-19-22-24 mm



000421087 **42/SC91**  
~~€ 78,50~~ **€ 63,50**

**Set of 9 combination wrenches with compact support**

- Compact, practical, easy-to-carry support
- Quickly identified wrench size
- Wrench safely locked in support

8-10-11-12-13-14-15-17-19 mm



000421070 **42/S26**  
~~€ 319,00~~ **€ 259,00**

**Set of 26 combination wrenches**

6-7-8-9-10-11-12-13-14-15-16-17-18-19-20-21-22-23-24-25-26-27-28-29-30-32 mm



**26x**

000420478 **42SLIM/B8NI**  
~~€ 79,00~~ **€ 63,50**

**Set of combination wrenches with thin open ends, in wallet**

10-11-12-13-14-15-17-19 mm

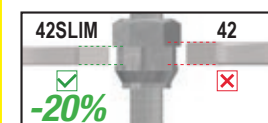

001410069 **141/B9**  
~~€ 129,50~~ **€ 106,50**

Set of 9 ratcheting combination wrenches, straight series, in cloth wallet

8-10-11-12-13-14-15-17-19 mm



001420259 **142SN/SC9**  
~~€ 182,50~~ **€ 138,00**

Set of 9 swivel end ratcheting combination wrenches with compact support

8-10-11-12-13-14-15-17-19 mm



001420087 **142/SC9I**  
~~€ 142,00~~ **€ 115,50**

Set of 9 reversible ratcheting combination wrenches, with compact support

8-10-11-12-13-14-15-17-19 mm



000550164 **55/B12N**  
~~€ 111,00~~ **€ 89,00**

Set of 12 double open end wrenches in roll-up wallet made of durable polyester

6x7-8x9-10x11-12x13  
 14x15-16x17-18x19  
 20x22-21x23-24x26  
 25x28-30x32 mm



**111**

Adjustable wrenches with scales, chrome-plated

- Movable jaw opening with right-hand rotation of pin
- Head angled at 22.5 degrees, with mm and inch scale



	L mm	A max	g		€
111/100	100	15 mm	60	001110010	<del>€ 13,30</del> <b>€ 10,80</b>
111/150	150	24 mm	165	001110015	<del>€ 13,40</del> <b>€ 10,90</b>
111/200	200	28 mm	325	001110020	<del>€ 17,00</del> <b>€ 13,90</b>
111/250	250	34 mm	505	001110025	<del>€ 21,10</del> <b>€ 17,20</b>
111/300	300	35 mm	790	001110030	<del>€ 27,50</del> <b>€ 22,70</b>
111/450	450	54 mm	2043	001110045	<del>€ 99,50</del> <b>€ 81,00</b>
111/600	600	62 mm	3300	001110060	<del>€ 138,00</del> <b>€ 112,50</b>

001860008 **186/260**  
~~€ 38,50~~ **€ 29,50**

Self-locking wrench with automatic take-up device for hexagons, 8 to 32 mm

Ideal for hexagon, Spline, square and Torx® head screws, including damaged screws.



- SPLINE® 12 sides
- square
- Torx®
- hexagon
- damaged screw 70%

001950066 **195/B5**  
~~€ 90,50~~ **€ 74,50**

Set of 5 reversible ratcheting double-ended angle head wrenches in wallet

8x10-12x13-14x15-16x18-17x19 mm



000960374 **96/SC9** ○  
~~€ 11,80~~ **€ 10,40**

Set of 9 ball head offset hexagon key wrenches

Ø mm	L mm
1,5	45
2	50
2,5	57
3	64
4	72
5	83
6	94
8	105
10	119



000960354 **96BPC/SC9** ○  
~~€ 21,40~~ **€ 17,80**

Set of 9 ball head offset hexagon key wrenches

Ø mm	L mm
1,5	79
2	84
2,5	89
3	99
4	108
5	126
6	148
8	168
10	187



000970164 **97BTX/SC8** ☆  
~~€ 40,50~~ **€ 34,00**

Set of 8 ball head offset key wrenches, long model, for Torx® head screws

Ø mm	L mm
T9	62
T10	71
T15	81
T20	92
T25	94
T27	105
T30	114
T40	129

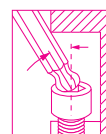

000961354 **96LBP/SC9** ○  
~~€ 18,90~~ **€ 15,20**

Set of 9 ball head offset hexagon key wrenches

Ø mm	L mm
1,5	90
2	100
2,5	112
3	127
4	144
5	163
6	184
8	204
10	230



**EXTRA LONG  
VERSION  
+30%**



000970364 **97BTXL/SC8** ☆  
~~€ 46,50~~ **€ 39,00**

Set of 8 ball head offset key wrenches, long model, for Torx® head screws

Ø mm	L mm
T9	80
T10	86
T15	100
T20	110
T25	126
T27	140
T30	160
T40	176



**EXTRA LONG  
VERSION  
+25%**



## THE FIRST ONE

Rapid and easy to handle.  
The small-size handle can be perfectly balanced to quickly rotate in the palm of the hand.  
The ergonomic shape allows the wrench to be used for extremely high torques as well.  
The hexagon ends are designed to transmit the maximum possible torque to the screw.



000960946 **96T/S5P** € 37,50 **€ 30,50**

Set of 5 offset hexagon key wrenches with handles

○ 2,5-3-4-5-6 mm



000970791 **97TTX/S6** € 58,50 **€ 43,00**

Set of 6 ball head offset key wrenches for Torx® head screws with handles

○ T10-T15-T20-T25-T30-T40



009510687 **951/S6** € 88,00 **€ 71,50**

Set of 6 T-handle wrenches with three hexagon male ends

○ 2,5-3-4-5-6-8 mm



## THE ORIGINAL ONE

When this wrench was launched, back in 1980, it was a revolution. Designed to work on high-resistance screws, it is the name for quick handling, accurate fit and flexible use.

The hexagon T handle can be adjusted as required.

The hexagon ends are designed to transmit the maximum possible torque to the screw.

The rod length allows remarkable torques to be effortlessly applied to the screws.

Ongoing production improvements have translated, for example, into sandblasted finishes and sharp-edged hexagon ends which allow a better fit onto any screws, including damaged ones. Laser marking results in a sturdier rod.

## THE RELIABLE ONE

Reliable, precise pre-positioning is the secret for the success of this wrench.

The articulated joint maintains its function over the years, no adjustment being required.

Socket rotation angle: 50°.

Can be used at 90° in fixed position.

Sliding T-handle, can be stopped in the required position throughout its length.

Triple size marking on head.

009520079 **952/D7** € 189,50 **€ 152,00**

Set of 7 T-handle wrenches with swivelling hexagon sockets

○ 7-8-10-12-13-14-17 mm

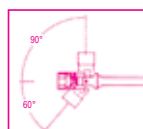





# Beta **evor**

## THE EVOLUTION OF THE SCREWDRIVER!

012031018 **1203E/D8P**    
~~€ 28,00~~ **€ 23,00**

Set of 8 screwdrivers

1201E  2,5x50-3x75-4x100-5,5x120  
6,5x150 mm

1202E  PH0x60-PH1x80-PH2x100 mm

012071207 **1207E/TX-D7**   
~~€ 28,50~~ **€ 23,10**

Set of 7 screwdrivers

1207E/TX  T6-T8-T10-T15  
T20-T25-T30

012031019 **1203E/D10N**    
~~€ 36,50~~ **€ 29,50**

Set of 10 screwdrivers

1201E  2,5x50-3x75-4x100-5,5x120  
6,5x150 mm

1202E  PH0x60-PH1x80-PH2x100 mm

1201E/N  0,8x4x30 mm

1202E/N  PH1x4,5x30 mm

012630008 **1263/D8**    
~~€ 42,00~~ **€ 33,50**

Set of 8 screwdrivers

1260  2,5x50-3x75-4x100- 5,5x125  
6,5x150 mm

1262  PH0x60-PH1x80-PH2x100 mm

012630010 **1263/D10**    
~~€ 52,50~~ **€ 42,00**

Set of 10 screwdrivers

1260  3x75-3,5x100-4x125-5,5x150-6,5x150 mm

1262  PH0x60- PH1x8-PH2x100 mm

1260N  4x30 mm

1262N  PH1x30 mm

012670307 **1267TX/D7**   
~~€ 38,50~~ **€ 31,00**

Set of 7 screwdrivers

1267TX  T6-T8-T10-T15  
T20-T25-T30



012930401 **1293/D6**    
~~€ 40,00~~ **€ 32,00**

Set of 6 screwdrivers

1290  0,6x3,5x75-1x5,5x150  
1,2x6,5x150 mm

1292  PH0x3x60 -PH1x4,5x80  
PH2x6x100 mm

**Betamax**  
MAXIMUM PERFORMANCE



012930408 **1293INOX/D8**    
~~€ 44,00~~ **€ 35,50**

Set of 8 screwdrivers made  
of stainless steel

1290INOX  2,5x50-3x75-4x100  
5,5x150-6,5x150 mm

1292INOX  PH0x60-PH1x80-PH2x100 mm

**Beta**  
**INOX**  
STAINLESS STEEL





000961619 **96BP-CL/SC9** ○  
 € 23,10 **€ 19,60**  
 Set of 9 ball head offset key wrenches, coloured

Ø mm	L mm
1,5	91
2	102
2,5	113
3	128
4	143
5	163
6	185
8	206
10	231

**EXTRA LONG VERSION**  
**+30%**



000971658 **97BTX-C/SC8** ☆  
 € 45,00 **€ 36,50**

Set of 8 coloured ball head offset key wrenches, for Torx® head screws

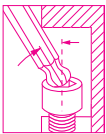

Ø mm	L mm
T9	80
T10	86
T15	90
T20	95
T25	100
T27	105
T30	114
T40	124



001422087 **142MC/SC9I** ○  
 € 143,00 **€ 122,00**

Set of 9 reversible ratcheting combination wrenches, coloured, with compact support

Ø mm	L mm
8x8	136
10x10	159
11x11	168
12x12	174
13x13	180
14x14	190
15x15	200
17x17	233
19x19	248



# COLOR

## ONE COLOUR, ONE SIZE

009202964 **920MC/C14** ○ 12" <sup>12</sup>  
 € 188,50 **€ 159,00**

14 coloured hexagon hand sockets and 5 accessories, in metal case

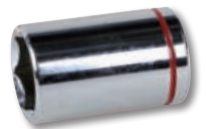

420x185x60 mm

4,2 kg

	920MC	8-10-11-12-13-14-15-16-17-18-19-21-22-24 mm
	920/21	125 mm
	920/22	255 mm
	920/25	
	920/42	
	920/55	



009002960 **900MC/C24** 14" <sup>14</sup>  
 € 253,00 **€ 203,50**

Assortment of 11 hexagon sockets, 13 coloured socket drivers and 6 accessories, in metal case

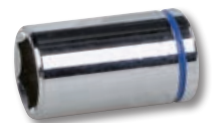

270x120x45 mm

1 kg

	900MC	4-5-6-7-8-9-10-11-12-13-14 mm
	900MC/PH	PH1 - PH2 - PH3
	900MC/TX	T10-T15-T20-T25-T27-T30- T40
	900MC/LP	0,8x4 - 1,2x6,5 - 1,2x8 mm
	900/20	50 mm
	900/21	150 mm
	900/25	
	900BG/30	
	900/42	
	900/55	

# CODE

## ONE COLOUR, ONE TIP STYLE

007202913 **720MC/C13** 12"   
 € 118,50 **€ 99,00**

Set of 13 impact sockets, 1/2" female drive, coloured, phosphatized, in metal case



335x145x60 mm

2,4 kg

012570210 **1257LPH/S8**   
 € 43,50 **€ 35,50**

Set of 8 micro-screwdrivers for slotted head screws and Phillips® screw in hard case

- 1257PH + PH00-PH0-PH1
- 1257LP ● 0,4x2-0,4x2,5-0,5x3  
0,6x3,5-0,8x4 mm



180x120x50 mm

012632008 **1263MC/D8**   
 € 44,50 **€ 36,00**

Set of 8 coloured screwdrivers

- 1260 ● 2,5x50-3x75-4x100-5,5x125  
6,5x150 mm
- 1262 + PH0x60-PH1x80  
PH2x100 mm



012672307 **1267MC/TX-D7**   
 € 48,50 **€ 32,50**

Set of 7 screwdrivers for Torx® head screws, coloured

- 1267TX ● T6-T8-T10-T15-T20-T25-T30



008600880 **860/C27** 1/4   
 € 48,50 **€ 41,50**

25 bits, 1 connector and 1 reversible ratchet in plastic case

- 860LP 0,5x3-1,0x5,5-1,2x6,5 mm
- 860PE 2-2,5-3-4-5-6-mm
- + 860PH PH1-PH2(x2)-PH3
- 860TX T6-T8-T10-T15-T20-T25-T30-T40
- + 860PZ PZ1 - PZ2(2x) - PZ3
- 860/55 100 mm
- 892/0



008600902 **860MIX/A31** 1/4   
 € 44,50 **€ 37,00**

Set of 30 bits with magnetic bit holder in plastic case

- 860LP 0,5x3 - 0,6x4,5 - 0,8x5,5  
1,0x5,5 - 1,2x6,5 mm
- 860PE 2-2,5-3-4-5-6-8-10 mm
- + 860PH PH0 - PH1 - PH2 - PH3 - PH4
- 860RTX T9-T10-T15-T20-T25-T27-T30-T40
- + 860PZ PZ1 - PZ2 - PZ3 - PZ4
- 882MSR/50 ○ 1/4 ● 1/4



008670901 **867/C52** 10mm  
~~€ 86,50~~ **€ 69,50**

52 hexagon bits,  
 10 mm and 2 accessories

	867PE	○	4-5-6-7-8-10-12 mm
	867PE/L	○	4-5-6-7-8-10-12 mm
	867XZN	○	M5-M6-M8-M10-M12
	867XZN/L	○	M5-M6-M8-M10-M12
	867TX	⊗	T20-T25-T30-T40-T45-T50-T55
	867TX/L	⊗	T20-T25-T30-T40-T45-T50-T55
	867RTX	⊕	T20-T25-T30-T40-T45-T50-T55
	867RTX/L	⊕	T20-T25-T30-T40-T45-T50-T55
	867/1	○	10 mm - □ 3/8"
	867/2	○	10 mm - □ 1/2"



250x170x70 mm

**2,1 kg**

016000008 **1600Q 8** 1/4  
~~€ 25,00~~ **€ 20,10**

**Four-way wrench for control panel operators**

Wrench for use for maintenance jobs in countless industries, e.g. electronics, hydraulics, ventilation and gas.



008620950 **862F/A7** 1/4  
~~€ 26,50~~ **€ 21,30**

**Set of 7 magnetic bits, hexagon sockets, in plastic case**



862F ○ 5,5-6-7-8-10-12-13 mm

016000010 **1600Q 10** 1/4  
~~€ 32,00~~ **€ 25,50**

**Eight-way wrench, with articulated joint, for control panel operators**

- Eight-way wrench, can be rotated to easily select the head to use.
- Magnetic articulated joint for increased force.
- 1/4" male drive for use of sockets.
- Wrench for use for maintenance jobs in countless industries, e.g. electricity, hydraulics, ventilation and gas.



012560100 **1256/C36-2**  
~~€ 47,50~~ **€ 38,50**

**Bi-material microscrewdriver with 36 interchangeable 4-mm bits and magnetic extension**

	1256TX	⊗	T3-T4-T5-T6-T7-T8-T9-T10-T15
	1256RTX	⊕	T6-T7-T8-T9-T10
	1256LP	●	0,8-1,2-1,5-1,8-2,2-2,5-3-3,5-4 mm
	1256PE	○	0,7-0,9-1,3-1,5-2 mm
	1256PH	⊕	PH000-PH00-PH0-PH1
	1256PZ	⊕	PZ000-PZ00-PZ0-PZ1
	1256/20		
	1256/30		



130x60x35 mm

**200 g**

009000882 **900/55Z**  
 € 38,50 **€ 25,00**

1/4" drive reversible ratchet,  
 72 tooth mechanism

5° take-up angle



72 tooth  
 mechanism  
 More compact  
 ratchet head

15 teeth  
 in contact  
 with gear  
 at all times

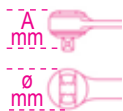

L mm	Ø mm	A mm	■
126	25	23	1/4

Reversible ratchet



	L mm	Ø mm	A mm	■	g	■	€
<b>910/55</b>	200	30	33	3/8"	239	009100882	€ 36,50 <b>€ 30,00</b>
<b>920/55</b>	275	40	43	1/2"	475	009200882	€ 46,00 <b>€ 38,50</b>



009000971 **900/C11** 14" 1/4"

€ 126,50 **€ 106,00**

11 hexagon sockets, 20 bits and 8 accessories,  
 in metal case

	861LP	●	0,5x3-0,8x5,5-1x5,5-1,2x6,5 mm
	861PE	○	3-4-5-6-8 mm
	861PH	⊕	PH0-PH1-PH2-PH3
	861TX	⊗	T8-T10-T15-T20-T25-T30-T40
	895/1	○	1/4" - 1/4"
	900	○	5-5,5-6-7-8-9-10-11-12-13-14 mm
	900/16	□	1/4" - 1/4"
	900/20		50 mm
	900/21		150 mm
	900/25		
	900/42		
	900BG/30		
	900/55	⊗	

270x120x45 mm



1,2 kg

009020807 **902A/C22** 12" 14"

€ 216,50 **€ 182,50**

Assortment of 22 hexagon sockets  
 and 6 accessories, in metal case

1/4"		900	○	5-5,5-6-7-8-9-10-11-12-13 mm
		900/20		50 mm
		900/25		
1/2"		900/55	⊗	
		920A	○	10-13-14-15-17-18-19-22-24 27-30-32 mm
		920/21		125 mm
		920/25		
		920/55	⊗	

420x185x60 mm



3,5 kg

**Assortment of 16 hexagon sockets and 5 accessories in foam tray, in metal case**

38"

	910A	○	6-7-8-9-10-11-12-13-14-15-16-17-18-19-21-22 mm
	910/21		125 mm
	910/22		250 mm
	910/25		
	910/42		210 mm



335x145x60 mm

009100936 **910A/C16** 38"  
~~€ 168,00~~ **€ 141,00**  
 Reversible ratchet (910/55)

009100935 **910A/C16HR** 38"  
~~€ 189,50~~ **€ 160,00**  
 Reversible ratchet with rotating handle (910/58)



**Assortment of 17 hexagon sockets and 5 accessories in foam tray, in metal case**

12"

	920A	○	10-11-12-13-14-15-16-17-18-19-20-21-22-24-27-30-32 mm
	920/21		125 mm
	920/22		255 mm
	920/25		
	920/42		305 mm



420x185x60 mm

009200924 **920A/C17M** 12"  
~~€ 197,00~~ **€ 167,00**  
 Reversible ratchet (920/55)

009200937 **920A/C17MR** 12"  
~~€ 217,50~~ **€ 183,50**  
 Reversible ratchet with rotating handle (920/58)



009280955 **928A/C12** 3/4"  
~~€ 527,00~~ **€ 417,00**

**Assortment of 12 hexagon hand sockets and 5 accessories, in metal case**

	928A	○	22-24-27-30-32-34-36-38-41-46-50-55 mm
	928/21		200 mm
	928/22		380 mm
	928/25		
	928/42		450 mm
	928/55	⊗	



530x220x80 mm



**622**

3/4" 1"

**Reversible ratchets for torque bars, round drive, Ø 22 mm**

	■	L mm	LA mm	📄	€
<b>622 3/4</b>	3/4"	110	56	006220019	<del>€ 141,50</del> <b>€ 115,00</b>
<b>622 1</b>	1"	110	56	006220024	<del>€ 171,00</del> <b>€ 140,00</b>

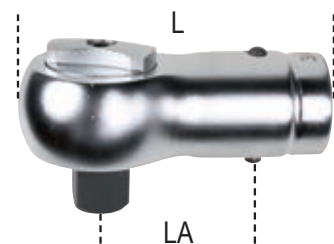

# //605E 1/4"

UNI EN 26789 ISO 6789

Click-type torque wrenches with reversible ratchets for right-hand and left-hand tightening torque accuracy:  $\pm 6\%$



	Nm mm	kgfm	lbf.in	■	L (mm)	g	006050105	€
<b>605E/5</b>	1÷5	0,1÷0,5	10÷45	1/4"	190	180	006050105	<del>€ 149,00</del> <b>€ 123,00</b>
<b>605E/10</b>	2÷10	0,2÷1,0	18÷90	1/4"	190	180	006050110	<del>€ 154,00</del> <b>€ 127,00</b>

# //666N

Click-type torque wrenches with reversible ratchets, for right-hand tightening, torque accuracy:  $\pm 3\%$

- Scale increased by 60% for improved visibility and setting accuracy
- Torque adjusting speed increased by 40%
- Red colour of o-ring indicates that wrench is unlocked and torque can be adjusted

- Handle and lens materials resistant to all chemical substances used in automotive sector, industry and aviation

UNI EN 26789 ISO 6789



	Nm mm	kgfm	lbf.in	■	L (mm)	g	006660002	€
<b>666N/2</b>	5÷25	0,5÷2,5	4÷18	1/4"	220	300	006660002	<del>€ 248,00</del> <b>€ 200,00</b>
<b>666N/2X</b>	5÷25	0,5÷2,5	4÷18	3/8"	220	300	006660003	<del>€ 249,00</del> <b>€ 201,00</b>
<b>666N/5</b>	10÷50	1÷5	7÷37	3/8"	325	660	006660005	<del>€ 159,00</del> <b>€ 128,00</b>
<b>666N/10</b>	20÷100	2÷10	15÷75	3/8"	367	730	006660010	<del>€ 160,00</del> <b>€ 129,50</b>
<b>666N/10X</b>	20÷100	2÷10	15÷75	1/2"	367	800	006660011	<del>€ 161,50</del> <b>€ 130,50</b>
<b>666N/20</b>	40÷200	4÷20	30÷150	1/2"	465	1010	006660020	<del>€ 177,00</del> <b>€ 143,00</b>
<b>666N/30</b>	60÷300	6÷30	50÷220	1/2"	581	1380	006660030	<del>€ 205,00</del> <b>€ 165,50</b>



# //674/C

## ROUND DRIVE Ø 22 mm

**NEW**

Click-type torque bars, round drive Ø 22 mm, for right-hand and left-hand tightening, torque accuracy:  $\pm 4\%$ , in case

- Dual scale for accurate torque adjustment
- Safety knob for maintaining set torque value
- When not in use, set torque to lowest value of torque wrench range



UNI EN ISO 6789



006740005 **674/C50**  
~~€ 555,00~~ **€ 477,00**

006740008 **674/C80**  
~~€ 602,00~~ **€ 516,00**

006740010 **674/C100**  
~~€ 611,00~~ **€ 524,00**

Nm	kgfm	Lbf.ft	L mm	kg
100÷500	10÷50	80÷400	786	3,4

Nm	kgfm	Lbf.ft	L mm	kg
160÷800	16÷80	120÷600	997	4,5

Nm	kgfm	Lbf.ft	L mm	kg
200÷1000	20÷100	150÷750	997	4,5

# //677/C 3/4"

Break-back torque wrenches with push-through ratchets, for right-hand and left-hand tightening, torque accuracy:  $\pm 4\%$  in case

UNI EN 26789 ISO 6789

677/C100



	Nm mm	kgfm	lbf.in	■	L (mm)	kg	006770606	€	€
677/C50	100÷500	10÷50	70÷350	3/4"	915	5,2	006770606	<del>€ 693,00</del>	€ 557,00
677/C70	150÷700	15÷70	100÷500	3/4"	1140	6,2	006770611	<del>€ 719,00</del>	€ 579,00
677/C100	300÷1000	30÷100	200÷750	3/4"	1470	7,5	006770615	<del>€ 854,00</del>	€ 695,00

UNI EN 26789 ISO 6789



006100025 **610/5** 12"  
~~€ 132,50~~ € 106,50

Click-type torque wrenches with reversible ratchets, for right-hand tightening, with 5 preset values, torque accuracy:  $\pm 4\%$

- Selectable torque values: 90 - 100 - 110 - 120 - 130 Nm
- Pull handle end to unlock wrench and select required tightening torque
- When not in use, set torque to lowest value of torque wrench range



**SUITABLE FOR TYRE REPAIRERS**

006100125 **610L/5** 12"  
~~€ 117,50~~ € 94,50

Click-type torque wrenches with L-shaped levers, for right-hand tightening, with 5 preset values, torque accuracy:  $\pm 4\%$

- Selectable torque values: 90 - 100 - 110 - 120 - 130 Nm
- Pull handle end to unlock wrench and select required tightening torque
- When not in use, set torque to lowest value of torque wrench range

# CE //665 12" 38"

Mechanical torque wrench with digital setting and reversible ratchet, for right-hand tightening, torque accuracy  $\pm 3\%$

- Auto power off after 30" when torque is set under minimum torque threshold
- Display will remain on with set torque value
- Torque setting to decimal digit
- Power supply: 1 battery 3V (included)



UNI EN 26789 ISO 6789

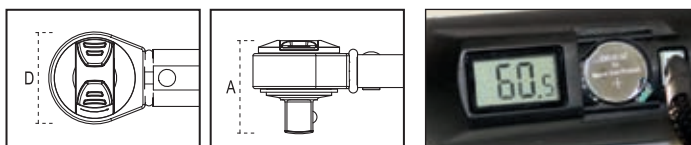

**QUICK, ACCURATE DIGITAL TORQUE ADJUSTMENT**

006650100 **665/SW**  
~~€ 16,80~~ € 14,40

Digital torque calibration device

Device allows calibration of wrenches item 665 with help of torque meters 680 and 682, without having to dismantle wrench. Fitted with a micro USB port, for firmware updates.



	Nm mm	■	D (mm)	A (mm)	L (mm)	g	006650006	€	€
665/6	10÷60	3/8	30	33	335	655	006650006	<del>€ 165,00</del>	€ 130,00
665/10	20÷100	3/8	30	33	375	725	006650010	<del>€ 166,50</del>	€ 131,50
665/10X	20÷100	1/2	30	37	375	725	006650011	<del>€ 168,00</del>	€ 132,50
665/20	40÷200	1/2	40	43	470	995	006650020	<del>€ 184,00</del>	€ 145,50
665/30	60÷330	1/2	40	43	590	1260	006650030	<del>€ 213,00</del>	€ 168,00



011690133 **1169BM/D3**  
~~€ 68,00~~ **€ 56,50**

Set of 1 combination pliers,  
 1 long needle nose pliers and  
 1 diagonal cutting nippers



1166BM 160 mm

1150BM 180 mm

1082BM 160 mm



011690273 **1169GBM/D3**  
~~€ 68,50~~ **€ 50,00**

Set of 1 combination pliers,  
 1 long needle nose pliers and 1 diagonal cutting  
 nippers, bi-material handles, industrial finishing



1082GBM 160 mm

1166GBM 160 mm

1150GBM 180 mm

011690014 **1169/D4**  
~~€ 75,50~~ **€ 62,50**

Set of 1 combination pliers,  
 1 long needle nose pliers,  
 1 cutting nippers and 1 slip joint  
 pliers with boxed joints



1082 160 mm

1150 180 mm

1166 160 mm

1048 250 mm

010310000 **1031/S4**  
~~€ 70,50~~ **€ 58,00**

Set of 4 circlip pliers

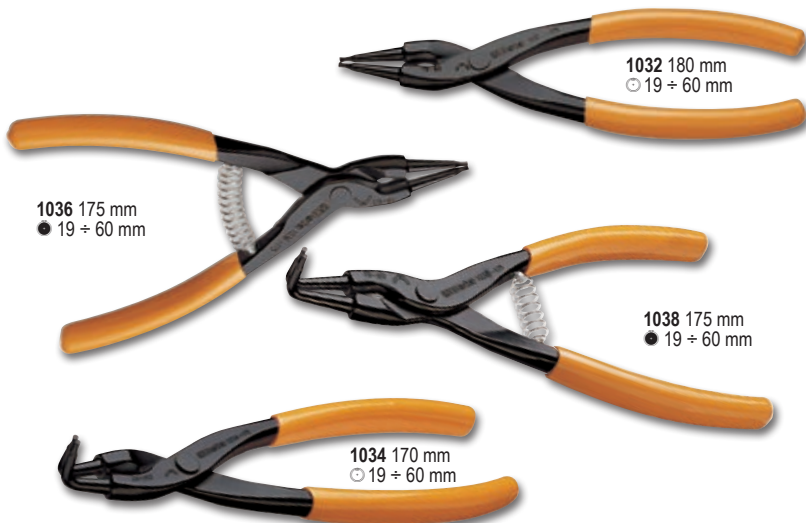

1036 175 mm  
 ● 19 ÷ 60 mm

1032 180 mm  
 ○ 19 ÷ 60 mm

1038 175 mm  
 ● 19 ÷ 60 mm

1034 170 mm  
 ○ 19 ÷ 60 mm

011500618 **1150HPC**  
~~€ 46,00~~ **€ 37,00**

Heavy duty universal pliers with cutting  
 edges made of sintered steel

- The decentralized pin allows the fulcrum to be closer to the cutting point, thereby resulting in an improved lever effect.
- Perfect alignment of the nose and the thin profile allow the pliers to be used in very small areas.
- The body of the pliers is made of a reliable molybdenum steel which has been heat treated in order to be flexible and resistant so as to guarantee a safe grip in any moment.

PATENTED



Average life of cutting edges = (test ISO 5744)	<b>65HRC</b>
Hardness of M2 steel cutting edges =	<b>-73%</b>
Shearing stress - static test =	<b>+127%</b>

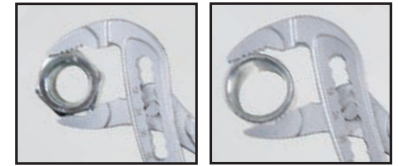

# // 1048

Slip joint pliers, boxed joints

010480010 **1048 175**  
~~€ 19,90~~ **€ 16,20**

L 175 mm	ø Max 32 mm	Max 30 mm
----------	-------------	-----------

010480015 **1048 250**  
~~€ 21,00~~ **€ 17,30**

L 250 mm	ø Max 50 mm	Max 48 mm
----------	-------------	-----------

010480020 **1048 300**  
~~€ 32,50~~ **€ 26,50**

L 300mm	ø Max 58 mm	Max 56 mm
---------	-------------	-----------

010470240 **1047/240**  
~~€ 29,00~~ **€ 23,50**

Slip joint pliers, push button alignment

- Quick, accurate adjustment by pressing push button
- No accidental misadjustment
- Heat-treated jaws

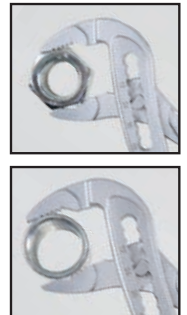

L 240 mm	ø Max 36 mm	Max 32 mm
----------	-------------	-----------

# // 1052

Adjustable self-locking pliers, concave jaws

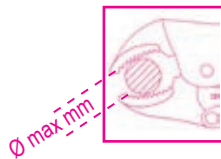

	L mm	ø Max mm	g		€
<b>1052/140</b>	140	22	175	010520014	<del>€ 12,90</del> <b>€ 10,70</b>
<b>1052/190</b>	190	36	360	010520019	<del>€ 14,70</del> <b>€ 12,20</b>
<b>1052/240</b>	240	42	590	010520024	<del>€ 18,80</del> <b>€ 15,50</b>
<b>1052/300</b>	300	55	900	010520030	<del>€ 27,00</del> <b>€ 21,60</b>

004370550 **437U/09**  
~~€ 278,00~~ **€ 215,50**

Assortment for repairing damaged threads in wooden case

- M5X0,8
- M6X1,0
- M8X1,25
- M10X1,5
- M12X1,75



370x230x55 mm

004370003 **437P**  
~~€ 34,50~~ **€ 27,50**

Thread dresser, for repairing internal and external, right-hand and left-hand threads

P 0,80÷3,00 mm



010090060 **1009L/DP-S2**  
~~€ 48,50~~ **€ 39,00**

Set of 2 extra-long, knurled double swivel nose pliers

**L 340 mm**



## 004120469 **412M/SP19** € 57,50 € 46,50

Set of 19 twist drills with cylindrical shanks, HSS, AISI M2, entirely ground finishing

- Self-centring
- High performance and cutting accuracy
- For drilling alloy steel, cast iron and metal in general

Ø 1÷10 x 0,5 mm

R ≤ 850 N/mm<sup>2</sup>  
HV ≈ 820  
DIN 338



≡ 115x170x40 mm

## 004150440 **415CO/SP19A** € 93,00 € 81,50

Set of 19 twist drills with cylindrical shanks, HSS-CO 5%

- For drilling holes into STAINLESS steel, alloy steel, cast iron, mild steel, light alloys

Ø 1÷10 x 0,5 mm

R ≤ 1400 N/mm<sup>2</sup>  
HV ≈ 850÷920  
DIN 338



≡ 115x170x40 mm

## 004120415 **412/SP25P** € 87,50 € 70,50

Twist drills with cylindrical shanks, short series, HSS, entirely ground glossy finishing

Ø 1÷13 x 0,5 mm

R ≤ 700 N/mm<sup>2</sup>  
HV ≈ 750÷820  
DIN 338



≡ 115x170x40 mm

## 004460060 **446/C110** € 655,00 € 542,00

Assortment of 105 chrome-steel taps and dies, metric thread, and 5 accessories for car repair jobs in wooden case

435/0 444/1 436/1  
435/3 444/2



III	III	III	III
430 M mm	433 M mm	440/440A M mm	441/441A M mm
2x0,4	6x0,75 - 7x0,75	2x0,4	6x0,75 - 7x0,75
3x0,5	8x0,75 - 8x1	3x0,5	8x0,75 - 8x1
4x0,7	9x0,75 - 9x1	4x0,7	9x0,75 - 9x1
5x0,8	10x0,75 - 10x1	5x0,8	10x0,75 - 10x1
6x1	10x1,25 - 11x0,75	6x1	10x1,25 - 11x0,75
7x1	11x1 - 11x1,25	7x1	11x1 - 11x1,25
8x1,25	12x0,75 - 12x1	8x1,25	12x0,75 - 12x1
9x1,25	12x1,25 - 12x1,5	9x1,25	12x1,25 - 12x1,5
10x1,5	14x1 - 14x1,25	10x1,5	14x1 - 14x1,25
11x1,5	14x1,5 - 16x1	11x1,5	14x1,5 - 16x1
12x1,75	16x1,5 - 18x1,5	12x1,75	16x1,5 - 18x1,5
14x2		14x2	
16x2		16x2	

≡ 500x337x60 mm

## 004530107 **453C/C7** € 288,00 € 176,50

Set of 7 core drills with Weldon shanks, short series, HSS-G

Ø 12-14-16-18-20-22  
+ ejector  
R ≤ 850 N/mm<sup>2</sup>



≡ 160x145x57 mm

## 004110197 **411/K7** € 47,00 € 38,00

Set of 7 multi-purpose drills, for cutting all materials, entirely ground, with U-shaped slots. With sharp plate and innovative geometry

Ø 3÷10 mm  
HVA~1650  
HRC~40÷50

≡ 160x98x18 mm



## 004250600 **425E/SP3** € 172,00 € 139,00

Set of 3 stepped drills, HSS-G, enhanced grinding efficacy

Ø 4÷12 ; 4÷20 ;  
4÷30 mm  
R ≤ 800 N/mm<sup>2</sup>  
HV 820



≡ 110x150x40 mm

# NEW BETA'S PULLER 1517C

relies on a leg self-locking mechanism triggered by the spring on the crosspiece. This feature makes it easy to position and lock the puller on the part to remove. After the puller has been fixed in place, the legs can be locked by means of the ring nut.

The peculiar crosspiece has 4 seats which allow the 1517C puller to be used with both 2 legs – for easier, quicker jobs – and 3 legs – for increased firmness. The shear pin on the screw head breaks when the maximum permissible torque is exceeded, thereby protecting the puller from overloads.

## //1517C

### Combination two/three-leg self-locking pullers

- Leg holder with configuration for 2- or 3-leg use
- Simultaneous leg opening
- Self-locking effect
- With shear pin
- Size 2 with screw extension (total length of screw with extension: 380 mm)



	A min+Max mm min+Max mm	L mm	L1 mm	mm		€
<b>1517C/0</b>	12÷140	145	250	18	015170500	€ 170,00 <b>€ 137,00</b>
<b>1517C/1</b>	20÷180	200	300	18	015170501	€ 209,00 <b>€ 168,50</b>
<b>1517C/2</b>	30÷280	270	300	18	015170502	€ 260,00 <b>€ 208,50</b>

## //1502

### Two-leg universal pullers with quick leg adjustment and closure

Specifications:

- For both internal and external use
- Legs can be moved along crosspiece
- Legs are locked by means of a quick lever release mechanism

### QUICK LEVER RELEASE MECHANISM



	A min+Max mm	A1 min+Max mm	L mm	L1 mm	mm		€
<b>1502/0</b>	40÷90	80÷130	100	166	17	015020000	<del>€ 95,00</del> <b>€ 76,50</b>
<b>1502/1</b>	50÷130	90÷170	100	166	17	015020001	<del>€ 103,00</del> <b>€ 83,00</b>
<b>1502/2</b>	65÷150	115÷210	150	247	22	015020002	<del>€ 164,50</del> <b>€ 132,00</b>
<b>1502/3</b>	65÷190	125÷260	150	247	22	015020003	<del>€ 181,50</del> <b>€ 146,00</b>
<b>1502/4</b>	70÷235	170÷335	200	321	27	015020004	<del>€ 312,00</del> <b>€ 251,00</b>

## // 015450011 1545/C5M

€ 379,00 **€ 297,00**

### Puller 1542/1 with 5 extractors 1544

	A mm	C mm
1544/1	9÷12	0,80
1544/2	13÷17	1,15
1544/3	16÷21	1,70
1544/4	20÷25	1,65
1544/5	25÷30	2,00

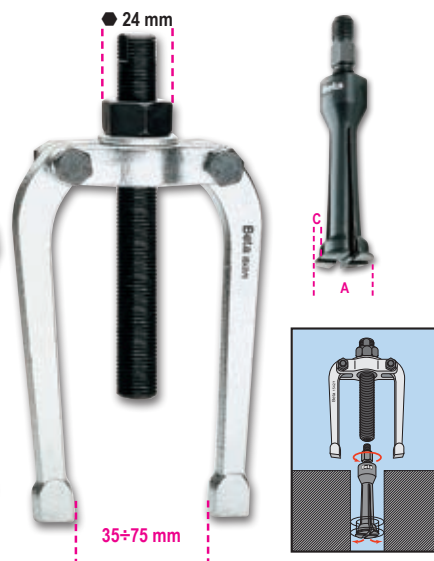

## // 014300105 1430/S5

€ 18,90 **€ 15,20**

### Set of 5 tapered extractors for brown screws and studs, made from hardened steel in case

1430/1-1430/2-1430/3  
1430/4-1430/5



265x180x45 mm

110x150x40 mm

**000310420 31BM/D6**  
~~€ 85,00~~ **€ 67,50**

Set of 6 pin punches  
 with handles  
 Ø 2-3-4-5-6-8 mm



**000320160 32AU**  
~~€ 39,50~~ **€ 31,00**

Automatic centre punches



**//1370**

Mechanic's hammers  
 wooden shaft

	g	g		€
<b>1370/300</b>	300	439	013700053	<del>€ 10,70</del> <b>€ 8,65</b>
<b>1370/500</b>	500	669	013700055	<del>€ 12,90</del> <b>€ 10,40</b>
<b>1370/800</b>	800	949	013700058	<del>€ 15,20</del> <b>€ 12,20</b>
<b>1370/1000</b>	1000	1180	013700060	<del>€ 18,40</del> <b>€ 14,80</b>
<b>1370/1500</b>	1500	1722	013700065	<del>€ 19,20</del> <b>€ 15,50</b>
<b>1370/2000</b>	2000	2181	013700070	<del>€ 21,70</del> <b>€ 17,60</b>



UNI 7778 DIN 1041

**//1370T**

Mechanic's hammers  
 fibre shaft

	g	g		€
<b>1370T/300</b>	300	452	013700630	<del>€ 14,30</del> <b>€ 11,90</b>
<b>1370T/500</b>	500	663	013700650	<del>€ 16,50</del> <b>€ 13,70</b>
<b>1370T/800</b>	800	1017	013700680	<del>€ 17,80</del> <b>€ 14,80</b>
<b>1370T/1000</b>	1000	1279	013700700	<del>€ 21,70</del> <b>€ 17,90</b>
<b>1370T/1500</b>	1500	1740	013700750	<del>€ 22,50</del> <b>€ 18,70</b>



**//1390**

Soft face hammers,  
 wooden shafts

	Ø mm	g		€
<b>1390/22</b>	22	134	013900022	<del>€ 14,30</del> <b>€ 11,50</b>
<b>1390/28</b>	28	230	013900028	<del>€ 17,70</del> <b>€ 14,20</b>
<b>1390/35</b>	35	365	013900035	<del>€ 24,50</del> <b>€ 19,70</b>
<b>1390/45</b>	45	698	013900045	<del>€ 38,50</del> <b>€ 31,00</b>
<b>1390/60</b>	60	1462	013900060	<del>€ 65,50</del> <b>€ 53,00</b>



UNI 7784

**NEW**

016970030 **1697 30**  
~~€ 199,00~~ **€ 160,00**

CE IP55

**Cross laser level, 30 metres, green beam, with magnetic base and wall-mount bracket, in case**

**TECHNICAL SPECIFICATIONS:**

- self-levelling cross
- self-levelling function can be switched off for manual use
- laser diode 515 Nm, class 2
- working range: 30 m
- accuracy: ± 1 mm at 5 m
- self-levelling range: 3° ± 0.5°
- body made of ABS and nonslip rubber
- 1/4" female drive
- 2xAAA batteries
- battery life: 4 hours



320x230x90 mm



**BASE:**

- 1 magnetic base for individual and combined use, 1/4" male drive
- 1 adjustable tightening bracket for several wood and metal profiles (for use in combination with magnetic base)
- quick horizontal and vertical alignment at a 90° angle



016930020 **1693 20**  
~~€ 100,00~~ **€ 81,50**

**20 m**

IP54  
 CE

**80 m**

**Laser distance meter, 20 m**

**MEASUREMENTS:**

- single distance measurement
- continuous measurement or minimal measurement
- Auto off feature
- Battery life: up to 4,000 measurements

**TECHNICAL DATA**

Measurement range: 0.05 ÷ 20m (0.2in ÷ 66f)  
 Scale selection: m, in, ft  
 Measurement accuracy: ±1,5 mm (± 0.06 in)  
 Laser class: 2  
 Battery: AAA 2 x 1.5



100 mm  
 23 mm  
 36 mm

115 mm  
 29 mm  
 48 mm

016930080 **1693M 80**  
~~€ 154,50~~ **€ 126,50**

**Laser distance meter, multipurpose, 80 m**

**MEASUREMENTS:**

- single distance measurement
- continuous measurement or minimal measurement

**FUNCTIONS:**

- addition/subtraction
- area measurement
- volume measurement
- indirect measurement (Pythagorean measurement)
- tilt measurement

- Auto off feature
- Soft cloth case (included)
- Battery life: up to 4,000 measurements

**TECHNICAL DATA**

Measurement range: 0.05 ÷ 80 m (0.2 in ÷ 229f)  
 Scale selection: m, in, ft  
 Measurement accuracy: ±1,5 mm (± 0.06 in)  
 Laser class: 2  
 Max. storage: 99 units  
 Battery: AAA 2 x 1.5V



# //1650

Sliding gauge made from hardened stainless steel

- Reading to 0.05 mm
- Spring locking

DIN 862

UNI EN ISO 13385-1

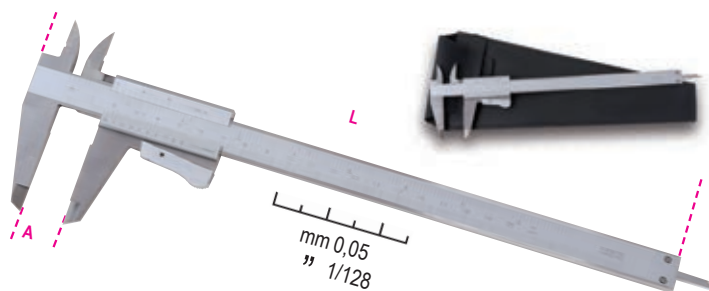

A MAX 150 mm L 225 mm

016500001 **1650/150**  
~~€ 47,50~~ € 37,50

A MAX 200 mm L 290 mm

016500002 **1650/200**  
~~€ 63,50~~ € 50,50

# //363

Heavy duty pipe wrenches made from light alloy



	L m	Ø (")	Ø (mm)		€
<b>363 350</b>	350	2" gas	60	003630035	<del>€ 43,00</del> € 35,00
<b>363 450</b>	450	2 1/2" gas	76	003630045	<del>€ 57,50</del> € 46,50
<b>363 600</b>	600	3" gas	90	003630060	<del>€ 105,50</del> € 85,00
<b>363 900</b>	900	5" gas	140	003630090	<del>€ 167,00</del> € 134,50

# // 017500100 **1750KG10**

~~€ 146,50~~ € 118,00

Lever-operated grease gun, 10 kg, with high-pressure hose, 2 m

Complete with swivel fitting, to avoid choking hose

Die-cast aluminium pump body with check valve

3 different pressure levels available:

- 4 g at 275 bar
- 7 g at 206 bar
- 9 g at 137 bar



# // 003420030 **342**

~~€ 39,00~~ € 31,00

Ratchet-type shears for plastic pipes



# // 017500500 **1750**

~~€ 32,00~~ € 24,90

Lever operated grease guns, 500 cc



550 Bar

018600255 **1860RG**  
 € 43,50 € 35,00

**Adjustable magnetic square, 30° ÷ 270°**

- Ideal for locking tubular or flat parts
- 15 kg magnetic force
- Supplied with an offset hexagon key wrench for locking angle adjustment mechanism
- Supplied with a pin for locking angle adjustment mechanism at 30°-45°-90°/270°-180°
- With hexagon hole making it easier to separate magnet from metal

30° ÷ 270°

15 kg



018600290 **1860EI**  
 € 26,50 € 21,50

**Magnetic square, 90°, for interior and exterior angles**

- Ideal for locking tubular or flat parts
- 18 kg magnetic force
- With bevels for 30° and 60° angles
- With hexagon hole making it easier to separate magnet from metal



90°

18 kg

018600210 **1860SQ**  
 € 65,50 € 52,00

**Magnetic square, 45°/90°**

- Ideal for locking tubular or flat parts
- 25 kg magnetic force
- No battery required, ON/OFF effect obtained by tilting interior magnets
- Easier chip removal with magnets in OFF position



25 kg

45°/90°



-20 ÷ +600°C



IP54 (CE)

017600710 **1760/TMC**  
 € 741,00 € 575,00

**Infrared thermal camera**

Compact thermal camera for contactless temperature measurement, suitable for applications in building, mechanical, electric installation and heating industries

- LCD TFT display, 2", 240x320
- Sensor, 32x32 pixels
- Acquisition frequency 7Hz
- Thermal sensitivity <347mK
- Automatic acquisition of hot and cold spots camera for acquisition of images in BMP format (max. 100 images) adjustable emissivity
- Power supply: 3 alkaline AAA batteries
- USB interface
- IP54
- Temperature range: -20 °C ÷ +600 °C
- Infrared band: 6.5÷14µm
- visible/infrared image fusion: 0.5; 1; 2m
- Alarm function, selecting acceptable maximum and minimum temperatures

018270100 **1827/K**  
 € 160,50 € 129,00

**Gas soldering iron with 7 accessories in case with soft polyethylene foam base**

- Power: 30 watts to 125 watts
- Tip temperature can be adjusted between 250 °C and 500 °C
- Gas flow regulator
- Warm-up time: 15 seconds
- Tank contains gas for 120 minutes' non-stop operation
- Clear tank for monitoring gas level
- Can be refilled with butane gas





070420001 **7042LCD**  
~~€ 144,00~~ **€ 112,50**

**Auto-darkening LCD mask, for electrode welding; MIG/MAG; TIG and plasma. Solar cells power supply and lithium batteries for outstanding LCD filter life**

- Viewing area: 98x43 mm
- Darkening shade: DIN 9-13, externally adjustable
- UV/IR protection
- Light to dark time: 1/25000 s
- Dark to light time: 0.25-1s
- Adjustable darkening sensitivity and delay
- Auto on/off
- Grinding feature
- Optimized shape to make it easier to breathe with pulled-down screen



070410001 **7041LCD/4S**  
~~€ 213,00~~ **€ 161,50**

**Auto-Darkening LCD mask, for electrode welding; MIG/MAG; TIG and plasma. 4 sensors with TRUE COLOR filter. Solar cell power supply and lithium batteries for outstanding LCD filter life.**

- Viewing area: 98x80 mm
- Darkening shade range: 5÷8.5/ 9-13, internally adjustable
- UV/IR protection: DIN16
- Light to dark time: 1/25000 s
- Dark to light time: 0.1-2.0s
- Adjustable darkening sensitivity and delay
- Auto on/off
- Grinding feature
- Low battery indicator
- Ergonomic design, lightweight, well-balanced
- With adjustable ring nut



070430001 **7043**  
~~€ 73,50~~ **€ 56,50**

**Auto-darkening LCD mask, for electrode welding, MIG/MAG, TIG and plasma, solar cell power supply**

- Viewing area: 92x43 mm
- Darkening shade: DIN 9-13, externally adjustable
- UV/IR protection
- Light to dark time: 1/1000 s
- Dark to light time: 0.1-1.0 s
- Adjustable darkening delay
- Auto on/off
- Grinding feature
- Optimized shape to make it easier to breathe with pulled-down screen



018520175 **1852R1750**  
~~€ 1.172,00~~ **€ 940,00**

**Portable induction heater**

- Heats and loosens stubborn bolts, hubs and bearings without using flames
- Allows any type of ferromagnetic metal to be heated

**MAXIMUM SAFETY WITHOUT USING FLAMES**

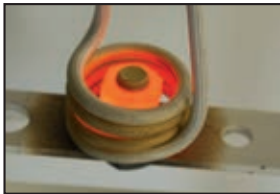

480x370x130 mm



**Technical data:**

- Input voltage: 230V AC, 50/60 Hz
- Input current: max. 7.5 A
- Power: max. 1.75 kW

**BENEFITS**

- 1 Time saving: quick, extremely accurate heating
- 2 Fire safety: does not produce flames, maximum operator safety
- 3 Functional: can be used with one hand, and coils can be easily interchanged

**FIELDS OF APPLICATION**

- Automotive industry
- Industrial maintenance
- Aviation industry
- Naval industry
- Petrochemical industry

**Standard equipment:**

- (1) Two front attachable coils, Ø 19 and 26 mm, for loosening nuts
- (3) One flat coil for heating surfaces
- (2) One flexible coil, 800 mm long
- Supplied in plastic case

017600020 **1760/RMS**  
~~€ 217,50~~ **€ 183,50**

**Industrial digital multimeter accurate and sturdy, in a 6-mm co-moulded shell, with antislip, shockproof outer rubber part**

- Water protection IP67
- Protection up to 1000V
- Tested for accidental falls up to 2 m
- Protected inlets • Autoranging
- Large direct reading display, backlit, blue
- K type temperature probe (included)
- Self-power down
- Rubber terminal base for enhanced operating comfort
- Double insulated terminals, 1000V, 1 m long
- Supplied in a soft case
- CAT IV 600V/ CAT III 1000V
- Actual effective value TRUE RMS

	Measuring range	Base accuracy
AC/DC voltage	110mV – 600V ±0.8%	- ±2% rdg
AC/DC current	110µA – 10A ±1.5%	- ±2% rdg
Resistance	110Ω – 40MΩ ±1.2%	- ±2.5% rdg
Capacity	11nF – 40mF ±5%	- ±10% rdg (up to 11mF)
Frequency	1100Hz – 110 MHz ±1.2%	- ±1.5% rdg
Temperature	-32°C – +1000°C ±3%	- ±5% rdg
Diode test	3V DC ±10% rdg	
Continuity test	<30 Ω	



011490010 **1149F**  
~~€ 12,00~~ **€ 9,60**

**Front wire stripping pliers with cutting blade, self-adjusting**



0,2÷6 mm<sup>2</sup>

**1740B**

**Compact heavy-duty riveting pliers**

- Optimized lever ratio for increased compactness and handiness.
- 3 jaws lock rivet for a perfect grip.
- Adjustable head for pulling rivet by 2 to 5 leg movements.

2,4÷4,8 mm steel

017400280 **1740B 280**  
~~€ 50,50~~ **€ 40,00**

2,4÷6,4 mm steel

017400330 **1740B 330**  
~~€ 57,00~~ **€ 45,00**



**3 JAWS:  
IMPROVED  
RIVET GRIP**



L 330 mm

WITH STEM TANK

016090101 **1609B**  
~~€ 246,50~~ **€ 198,50**

**Mechanical crimping pliers**

- For noninsulated copper terminals, 10÷120 mm<sup>2</sup>
- Antislip rubber handle
- Internal "H" section pin for unparalleled punch smoothness
- Made from burnished steel



10÷120 mm<sup>2</sup>



L 600 mm

017410000 **1741B**  
~~€ 27,50~~ **€ 22,80**

Riveting pliers supplied with 4 interchangeable nozzles

ø mm	2,4	3,2	4	4,8	5
Aluminium	•	•	•	•	•
Steel	•	•	•	•	•
Stainless steel	•	•	•		



L 250 mm

017410450 **1741U**  
~~€ 32,00~~ **€ 25,50**

Ultra compact riveting pliers with adjustable force

ø mm	2,4	3	3,2	4	4,8
Aluminium	•	•	•	•	•
Steel	•	•	•	•	
Stainless steel	•	•	•	•	



3 JAWS:  
IMPROVED  
RIVET GRIP



L 200 mm

017490005 **1749AC**  
~~€ 29,00~~ **€ 23,40**

High thrust gun for chemical binders



230 mm  
 STANDARD Ø 50 mm

017490010 **1749A**  
~~€ 30,00~~ **€ 24,00**

Bonding gun, professional model aluminium tube



018700220 **1870I**  
~~€ 191,00~~ **€ 153,00**

Solid and fluid vacuum cleaner, 20 l, stainless steel drum

CARATTERISTICHE TECNICHE

- single-stage by-pass motor
- voltage: 230/240 V
- frequency: 50/60 Hz
- max. power: 1200 W
- airflow rate: 58 l/sec.
- max. suction pressure: 190 mbar
- max. drum capacity: 20 l, made of stainless steel
- acoustic emissions: <70 dB(A)
- cable length: 5 m

STANDARD ACCESSORIES Ø 36 mm

- 1 corrugated hose with ergonomic handle and vent
- 2 hard extension tubes
- 1 multiuse brush for floors and fluids
- 1 flat nozzle
- 1 paper bag



**NEW**

FILTERING SYSTEMS

- 1 surface air filter cartridge 1900 cm<sup>2</sup> - 12 µm nom.
- 1 anti-foam filter PPI 45/PPI 30

**1833...**  
**High-brightness LED torch, made of sturdy anodized aluminium**  
 • adjustable focus  
 • 2 brightness settings



Battery life  
 10.0 h - L 150 mm  
 018330002 **1833 S**  
 € 28,50 € 22,40



Battery life  
 7.5 h - L 162 mm  
 018330003 **1833 M**  
 € 35,50 € 28,00



Battery life  
 8.5 h - L 196 mm  
 018330004 **1833 L**  
 € 61,00 € 48,50



Battery life  
 22 h - L 300 mm  
 018330005 **1833 XL**  
 € 76,00 € 60,00



CE  
 018380221 **1838SLIM**  
 € 46,50 € 37,00

**Rechargeable, articulated slim 3-LED inspection lamp**

- Magnetic base
- Charging time: 2.5h
- Battery life: 2-4h/ spot 3h

**Triple light emission**

- front: 100/200 lumens
- back: 180 lumens
- spot (head): 80 lumens



L 370 mm



307x29x17 mm

CE  
 018380400 **1838AM**  
 € 81,50 € 65,50

**Rechargeable LED inspection lamp, with double light emission, articulated, can be rotated 180°, with swivel magnetic base and hook**

- double light emission: front: LED COB, 60-700 lumens, can be adjusted with potentiometer spot (head): LED SMD, 120 lumens, ON-OFF switch
- rechargeable 3.6V 2600mAh Li-ion battery
- with USB-C port
- supplied with 100-240V / 50-60Hz charger
- charging time: 4h
- battery life: front: 2.5-16h spot (head): 10h
- 3-LED battery level indicator
- articulated, can be rotated 180° (± 90° compared to axis)
- magnetic base (with neodymium magnet), can be rotated 90°
- swivel base hook

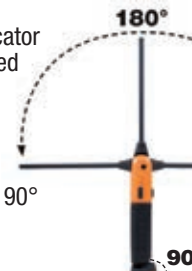

L 405 mm



018380300 **1838FLASH**  
 € 286,00 € 216,50

**Rechargeable, ultracompact spotlight, designed to offer the best possible solution for each use**

- IP65 - without external power supply
- Dual brightness: 650 / 300 lumens
- Lithium polymer battery 7.4 V 4000 mAh

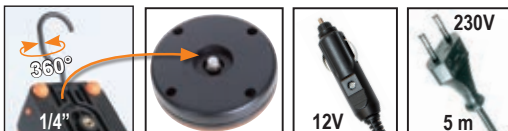

85x100x155 mm



018380122 **1838S**

€ 66,50 € 53,00

**Rechargeable, articulated LED inspection lamp**

- can be rotated 180°
- nonslip rubber body
- double swinging hook
- magnets on base and back for increased adjustability
- complete with charger (100-240V / 50-60Hz)
- charging time: 4h
- battery life: 2-7.5 h



018360050 **1836A**

€ 48,50 € 32,50

**LED headlamp, dual brightness, with contactless ON/OFF sensor**

- 120/65 lumens
- IP54
- Batteries: 3xAAA included

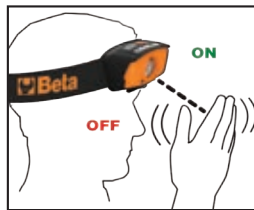

**1837C**



**Rechargeable LED spotlight for building yards**

- 3 brightness settings
- battery charger: input: 100-240V AC - 50/60Hz; output: 15V 1.5A
- charging time: 4 hours
- 3-LED charge indicator
- can rotate up to 180°
- IP65
- IK07



500/1000/2100 lumen

018370210 **1837C/2100**  
€ 124,00 € 100,00



1100/2200/4300 lumen

018370430 **1837C/4300**  
€ 187,00 € 150,50



018380010 **1838COB**

€ 76,00 € 58,00

**Compact rechargeable inspection lamp with ultra-brightness LED. Lithium polymer battery**

- Compact body made of antislip rubber
- Swinging hook
- Magnetic base can be rotated 180 degrees
- With charger 100-240Vac / 50-60Hz
- 100/200 lumens - spot 75 lumens
- Operating range: 5 / 2.5 hours
- IP65

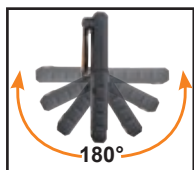

018380111 **1838/11LED**  
€ 117,50 € 92,50

**Rechargeable inspection lamp with ultra-high brightness LEDs, lithium polymer battery**

- Compact body made of antislip rubber
- With charging station, 110-230Vac
- With multidirectional head LED





**NEW**

018380270 **1838E**  
~~€ 139,50~~ **€ 112,00**

**Rechargeable under bonnet LED lamp**

- Triple light emission: 500/1000/2000 lumens
- Can be rotated 360°
- Length range: 116 ÷ 188 cm
- Aluminium body
- Nonslip rubber hooks
- USB-C charge
- Supplied with battery charger  
 Input: 100-240V ~ 50/60Hz  
 Output: DC 5V - 2000 mA
- battery life: 3-9 h



- 2 charging modes:**
- charge via lamp USB port
  - charge via internal battery USB port

018380271 **1838E-BT**  
~~€ 39,50~~ **€ 31,50**

**Rechargeable battery with USB-C port for under bonnet lamp item 1838E**

- Li-Ion 3,6V
- DC 5V - 2000 mA



018370450 **1837M**  
~~€ 204,50~~ **€ 164,50**

**Rechargeable LED COLOUR MATCH spotlight, for visual colour control, high colour rendering index (CRI 96+), up to 2,000 lumens**

- 3 brightness settings: 500/1,000/2,000 lumens
- CRI (colour rendering index): 96+
- CCT (correlated colour temperature): 2700K/ 3500K/ 4500K/ 5500K/ 6500K
- battery charger: input: 100-240V AC - 50/60Hz; output: 15V 1.5A
- quick release charge connector
- charging time: 3.5 hours
- battery life: 8/4/2 h
- charge indicator
- button and LED colour temperature indicator
- button and LED brightness indicator
- can rotate up to 180°
- IP65
- IK07



**96 CRI+**



220x225x70 mm

**NEW THE NEW RANGE OF REELS**

Beta's new, varied, comprehensive range of reels has been designed and developed with a view to satisfying all professionals' requirements. High-resistance spring ensuring remarkable durability and unparalleled smoothness. Drums made of thick polypropylene, for unique shock resistance. Rack device causing automatic cable rewind to stop, easy to disable, to allow continuous pulling. Each reel is fitted with a 180° swivel wall-mount bracket and an additional bracket for quick connection to, and disconnection from, the wall-mount support.

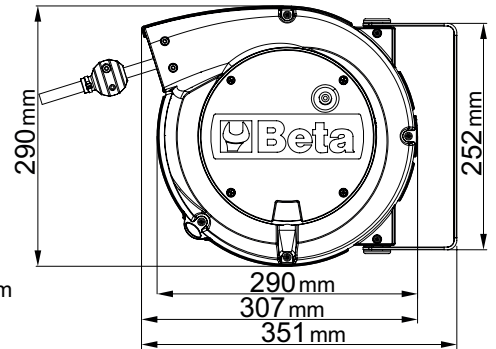
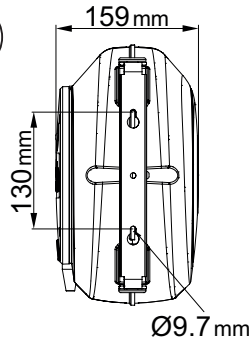

- length of cable out of drum: 1 m
- rack mechanism can be disabled to keep cable pulled
- coiled cable length: 15 m



018420821 **1842 15-H05/LED**  
~~€ 258,00~~ **€ 207,50**

**Automatic cable reel with LED inspection lamp, 100-240Vac**

- with 230/12V safety transformer
- H05VV-F 2x1.0 mm<sup>2</sup> cable



018440315 **1844 15-H05**  
~~€ 153,50~~ **€ 123,50**

**Automatic cable reel, with 3Gx1.5 mm<sup>2</sup> cable**

- 3Gx1.5 mm<sup>2</sup> cable
- with thermal protection switch
- max. power (rolled up): 1500W (230V-20°C)
- max. power (unrolled): 2500W (230V-20°C)



018440316 **1844 15-H05/SCK**  
~~€ 180,00~~ **€ 144,50**

**Automatic cable reel, with 3Gx1.5 mm<sup>2</sup> cable and SCHUKO type socket**

- 3Gx1.5 mm<sup>2</sup> cable
- with thermal protection switch
- max. power (rolled up): 1500W (230V-20°C)
- max. power (unrolled): 2500W (230V-20°C)



017600025 **1760/OHM**   
 € 662,00 € 522,00

**Multimeter/megohmmeter  
 for high voltage insulation testing  
 TRUE RMS indicator**



  
 CAT. IV 600V  
 CAT. III 1000V

<b>Measuring range</b>	<b>Base accuracy</b>
AC/DC voltage: 50mV - 1000V	±0.06% - ±0.1% rdg
AC/DC current: 0.01µA - 10A	±0.5% - ±1% rdg
Resistance: 0.01Ω - 50MΩ	±0.2% - ±2% rdg
Meg OHM: 0.01 - 5000MΩ	±4% rdg. max current 1mA
Capacity: 5nF - 10mF	±1.5% - ±3% rdg
Frequency: 50Hz - 100 MHz	±0.02% - ±0.1% rdg
Temperature: -50 °C - +1350 °C	±0.5% rdg
Diode test: 3V dc	
Continuity test: <30 Ω	

059880400 **5988VHB-MQ/A**  
 € 1.960,00 € 1.590,00

**Assortment of 66 insulated tools, 1000V,  
 in soft foam trays**



Quantity/Description	Beta N.	TR
12 single open end wrenches, 1000V 7-8-10-11-12-13-14-15-16-17-19-22 mm	52MQ	M49
12 single ring wrenches 7-8-10-11-12-13-14-15-16-17-19-22 mm	89MQ	M49
4 socket drivers for hexagon screws $\odot$ 4-5-6-8 mm	910MQ/PE	M108
11 bi-hex sockets $\odot$ 7-8-10-11-12-13-14-15-16-17-19 mm	910MQ/B	M108
6 socket drivers for Torx® head screws $\odot$ T15-T20-T25-T27-T30-T40	910MQ/TX	M108
2 socket drivers with XZN® profile $\odot$ 8-10 mm	910MQ/XZN	M108
1 3/8" drive extension 125 mm	910MQ/21	M108
1 3/8" drive extension 250 mm	910MQ/22	M108
1 3/8" drive, T-handle	910MQ/T	M108
1 3/8" drive reversible ratchet	910MQ/55	M108
1 electrician's scissors	1128MQ	M161
1 slip joint pliers, boxed joint 250 mm	1048MQ	M161
1 diagonal cutting nippers 1000V $\leq$ 160 mm	1082MQ	M161
1 combination pliers 1000V $\equiv$ 180 mm	1150MQ	M161
1 extra long flat nose pliers $\equiv$ 160 mm	1162MQ	M161
1 extra-long bent flat nose pliers $\equiv$ 160 mm	1164MQ	M161
4 screwdrivers for cross head Phillips® screws, 1000V $\bullet$ PH0x60 - PH1x80 - PH2x100 - PH3x150 mm	1272MQ	M161
4 screwdrivers for headless slotted screws, 1000V $\bullet$ 2,5x75 - 3x100 - 4x100 - 5,5x125 mm	1274MQ	M161
1 cable stripping knife, insulated	1777MQ/U	M161

24

15

27

M49

M161

M108

021150332 **2115PL-MQ32**  
 € 806,00 € 647,00

**Assortment of 32 insulated tools  
 for hybrid cars,  
 in plastic tool box with soft  
 thermoformed tray**



$\Delta$  1000 V

Quantity/Description	Beta N.
1 1/2" reversible ratchet	920MQ/55A
1 single ring wrenches 10-12 mm	89MQ
1 magnetic bit holder, insulated $\bullet$ 1/4"	850MQ
10 set of 10 bits with magnetic bit holder $\odot$ T7-T8-T9-T10-T15-T20-T25-T27-T30-T40	860TX/A10
7 hexagon sockets $\odot$ 8-10-12-13-14-17-19 mm	920MQ/A
1 1/2" square drive extension bar 125mm	920MQ/21
1 1/2" square drive extension bar 250mm	920MQ/22
1 slip joint pliers, boxed joint 250mm	1048MQ 250
1 combination pliers 1000V $\equiv$ 180mm	1150MQ
1 extra-long bent flat nose pliers $\equiv$ 160mm	1164MQ160
2 screwdrivers for cross head Phillips® screws, 1000V $\bullet$ 4.5X80-6X100mm	1272MQ
3 screwdrivers for headless slotted screws, 1000V $\bullet$ 3X100-4X100-5.5X125	1274MQ
1 insulating gloves, made from latex G2	1995MQ/G2
1 tool box, long series, made from plastic	CP15L

020010154 **2001/BZ24 MQ**  
 € 232,00 € 186,00

**Folding tool case with assortment  
 of 24 tools, for electricians**

**NEW**



24

380x290x60 mm



Quantity/Description	Beta N.
1 electrician's scissors, straight blades	1128BMX
1 combination pliers 1000V $\equiv$ 180 mm	1150MQ
5 combination wrenches 8-10-13-17-19 mm	42
3 screwdrivers for headless slotted screws, 1000V $\bullet$ 3x100 - 4x100 - 5,5x125 mm	1274MQ
3 screwdrivers for cross head Phillips® screws, 1000V $\bullet$ PH0x60 - PH1x80 - PH2x100 mm	1272MQ
9 ball head offset hexagon key wrenches burnished $\odot$ 1,5-2-2,5-3-4-5-6-8-10 mm	96BP/SC9
1 mains testing screwdriver $\bullet$	1253
1 diagonal cutting nippers 1000V $\leq$ 160 mm	1082MQ



## A NEW PERSPECTIVE

To redesign our electrician's scissors, we observed users' daily work. We have made it into a universal tool, incorporating the 4 main features into one object.

### Cutting

Quick and sharp, for cables up to 50 mm<sup>2</sup>. With a cable cutting groove and a microtoothed blade, for improved hold.

### Crimping

Safe and durable, for tube terminals.

### Stripping

The sensitive anti-loosening pin allows even the thinnest cables to be accurately stripped.

### Countersinking

The unique milling profile allows the holes in pull boxes to be countersunk accurately and neatly.



011280095 **1128FXS**

~~€ 21,40~~ € 17,60

Electrician's scissors with graduated milling profiles, straight stainless steel blades, with microteeth, cable cutting groove and crimping pliers for tube terminals

- Articulated belt hook case
- Bimaterial handles
- Anti-loose pin
- Profile and mill: designed to enlarge holes on plastic, from 13 to 21 mm



017780088 **1778P**

~~€ 27,00~~ € 21,80

Foldaway knife, stainless steel and aluminium blade and handle, with push button opening mechanism in case



017780080 **1778SOS**

~~€ 19,40~~ € 16,00

Car service knife with window breaking hammer and seat belt cutter features, in case

- With clip and fabric wallet with loop
- Anodized aluminium handle
- Safety blade lock



011280088 **1128BAX**

~~€ 23,30~~ € 19,10

Double-acting electricians' scissors, with milling profiles in DLC-coated stainless steel

- High blade surface hardness (resistance to abrasion and wear)
- Low coefficient of friction (smoothness and anti-adherence)
- With articulated plastic case

**+HARDNESS  
-COEFFICIENT  
OF FRICTION**



*profile and mill:  
designed to enlarge  
holes on plastic,  
from 13 to 25 mm.*



017710050 **1771BM**

~~€ 15,50~~ € 11,60

Utility knife, 18 mm, 6 spare blades

- Nonslip bi-material handle
- Automatic blade loading
- Blade locking nut for maximum blade stability under stress conditions
- Nonreturn safety slider



017720040 **1772M**

~~€ 14,00~~ € 11,30

Safety utility knife with retractable blade, supplied with 3 blades

- Blade retracts through an automatic spring mechanism
- Die-cast alloy body
- Staple remover built into handle



**ADJUSTABLE CUTTING  
DEPTH Ø÷25 MM**

017260050 **1726BM**

~~€ 35,50~~ € 28,50

Hacksaw frame with quick release blade attachment system

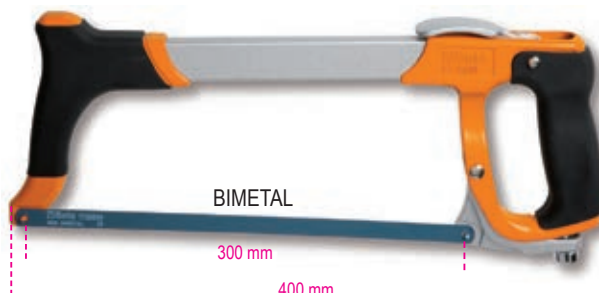



SILIC SPRAY

097292040 **9729**

Not available for Baltic countries

### Silicone spray

Silicone lubricant and detacher. Suitable for lubricating plastic, rubber and metal parts. Protects from corrosion. Detaching, antiadhesive for plastic and rubber moulding. Antistatic, for worktops. Waterproof, protects from humidity and weather corrosion. Protective, for electric circuits. Can be used to polish wood, plastics and rubber. Solvent-free.



MULTI GREASE

097202040 **9720**

Not available for Baltic countries

### Multipurpose grease

Particularly useful for lubricating chains, gears and moving metal parts as well as hinges, locks and pivots. Resistant to friction and weather. Highly resistant to high temperatures (up to 210°C). Highly adhesive. Does not drip.



LUBRIBETA UNIVERSAL

7-in-1 multipurpose unlocking lubricant  
Adjustable Straw.  
7 in 1.

Directions for use:  
Apply product and wait a few minutes.  
To unlock:  
use suitable tools.  
To degrease:  
clean with a cloth.



097102040 **9710**

Not available for Baltic countries

CUTTING OIL

097382040 **9738**

Not available for Baltic countries

### Cutting oil

Highly lubricating and protective. Suitable for milling, boring, threading, drilling and manual and automatic machine working. Highly resistant to oxidation. Water washable. Solvent-free.



ZINC 98%

097522040 **9752**

Not available for Baltic countries

### Clear zinc

Highly covering, it is ideal for galvanizing iron parts, welding touch-ups, nuts, bolts and parts subject to weathering. Particularly resistant to oxidation and abrasion. Highly adhesive, it forms an elastic film of very light colour, similar to hot galvanizing. Can be overpainted. Also ideal as a final protectant. Does not drip.



**9802M**

### Threadlocker

Ideal for fixing parts subject to periodic maintenance, bearings and bushes. Allows dismantling by using hand tools.



20 ml	098022002	Not available for Baltic countries
50 ml	098022005	Not available for Baltic countries

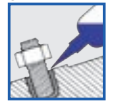

RED SEAL

098412020 **9841R**

Not available for Baltic countries

Red acetic-reticulation silicone sealant, resistant to high temperatures, with convenient pressure dispenser (pressure pack)

Withstands temperatures up to 300°C



BLACK SEAL

098412120 **9841N**

Not available for Baltic countries

Black acetic-reticulation silicone sealant, resistant to high temperatures, with convenient pressure dispenser (pressure pack)

Withstands temperatures up to 240°C



**9803H**

### Threadlocker

Ideal for permanent locking of parts that do not need subsequent dismantling, and for passivated metal surfaces, including brass, aluminium and stainless steel. Does not allow disassembly with hand tools.



20 ml	098032002	Not available for Baltic countries
50 ml	098032005	Not available for Baltic countries



NEW

5 gr

098510500 **9851 T5**

Not available for Baltic countries

### Instant glue

For structural joints. Based on ethyl cyanoacrylate. For adhesion of a wide range of materials, including metal, plastics, leather, wood and several other types of substrates, whether combined with each other or separate. Bonds quickly.



## 330 Twin Cut PLUS

Cutting discs for carbon and stainless steels

The reduced thickness of the discs makes the cutting faster. Extremely high performance properties.

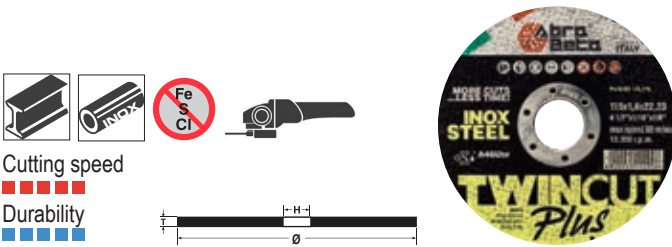

Cutting speed



Durability



Diameter Ø mm	Thickness T mm	Hole H mm	Specification		pcs. in pack	€
115	1,0	22,23	A46 T41	000330115	50	<del>€ 0,79</del> € 0,68
125	1,0	22,23	A46 T41	000330125	50	<del>€ 0,87</del> € 0,72
230	2,0	22,23	A46 T41	000330230	25	<del>€ 2,48</del> € 2,23

## 121 PLATINUM

Mounted flap wheels with zirconia cloth

Intended processing of steel and non-ferrous metals



Ø mm	Height H mm	Grit		pcs. in pack	€
30	20	P 40	001213246	25	<del>€ 2,10</del> € 1,89
30	20	P 60	001213266	25	<del>€ 2,10</del> € 1,89
30	20	P 80	001213286	25	<del>€ 2,10</del> € 1,89
50	30	P 40	001215346	25	<del>€ 2,78</del> € 2,50
50	30	P 60	001215366	25	<del>€ 2,78</del> € 2,50
50	30	P 80	001215386	25	<del>€ 2,93</del> € 2,64
60	30	P 40	001216346	25	<del>€ 3,35</del> € 2,99
60	30	P 60	001216366	25	<del>€ 3,35</del> € 2,99
60	30	P 80	001216386	25	<del>€ 3,45</del> € 3,10
80	30	P 60	001218366	25	<del>€ 4,45</del> € 4,00

## 115 DIAMOND

Ceramic abrasive cloth discs with polyester backing pad

Designed for very intensive grinding of carbon steels, welds and hard alloys.

Cloth treated with grinding active additive to avoid overheating of the work surface.

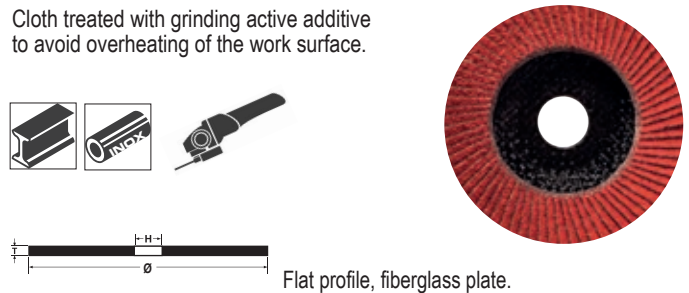

Flat profile, fiberglass plate.

Diameter Ø mm	Hole H mm	Grit		pcs. in pack	€
125	22,23	P 40	001151104	20	<del>€ 5,00</del> € 4,50
125	22,23	P 60	001151106	20	<del>€ 5,00</del> € 4,50

Conical profile, fiberglass plate.

Diameter Ø mm	Hole H mm	Grit		pcs. in pack	€
125	22,23	P 40	001152104	20	<del>€ 5,00</del> € 4,50
125	22,23	P 60	001152106	20	<del>€ 5,00</del> € 4,50

## 122 DIAMOND

Mounted flap wheels ceramic-abrasive cloth

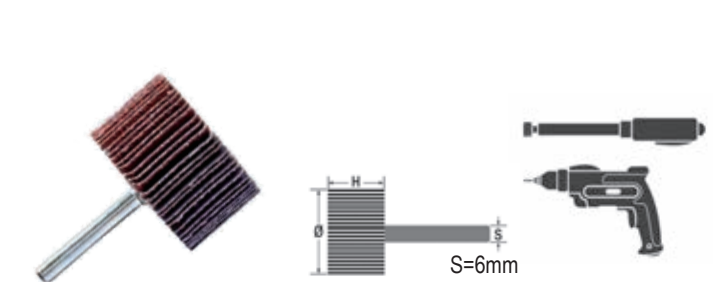

Ø mm	Height H mm	Grit		pcs. in pack	€
30	20	P 40	001223246	25	<del>€ 2,47</del> € 2,22
30	20	P 60	001223266	25	<del>€ 2,47</del> € 2,22
40	30	P 40	001224346	25	<del>€ 2,82</del> € 2,54
40	30	P 60	001224366	25	<del>€ 2,90</del> € 2,61
50	30	P 40	001225346	25	<del>€ 3,30</del> € 2,99
50	30	P 60	001225366	25	<del>€ 3,30</del> € 2,99
60	30	P 40	001226346	25	<del>€ 3,85</del> € 3,50
60	30	P 60	001226366	25	<del>€ 3,85</del> € 3,50

**10508 PLATINUM**

Ventilated cloth discs, zirconium grain

Intended for grinding carbon steel, stainless steel and non-ferrous metals.

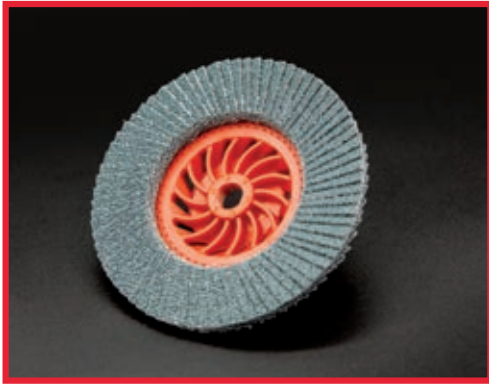

Vents in the plate for air circulation and additional material cooling.



M14 threaded mounting hole enables a quick replacement of the grinding wheel without the use of tools



Diameter Ø mm	Hole H mm	Grit		pcs. in pack	€
<b>125</b>	M14 mm	P 40	001050804	20	<del>€ 4,10</del> <b>€ 3,70</b>
<b>125</b>	M14 mm	P 60	001050806	20	<del>€ 4,10</del> <b>€ 3,70</b>
<b>125</b>	M14 mm	P 80	001050808	20	<del>€ 4,10</del> <b>€ 3,70</b>
<b>125</b>	M14 mm	P 120	001050812	20	<del>€ 4,10</del> <b>€ 3,70</b>



## THE NEW RANGE OF BETA-BRANDED ANGLE GRINDERS

**Power, Reliability and Durability** are the three hallmarks of the new range, with the focus also being on maximum safety and ease of use for professionals.

• **Outstanding performance:**

Powerful, resin-bonded, wear-resistant, durable motor  
Air vents providing optimal cooling, protected against dust infiltration

• **Unparalleled safety for operators:**

Spindle lock device for quick disc changes  
Protection against accidental activation  
Smooth start, for limiting large initial inrush of current on start-up

• **Unique comfort and ease of handling:**

Nonslip ergonomic handle for improved grip  
Lowered head that allows working in confined spaces  
Tangle-free cable no less than 4 metres in length for increased ease of movement  
Additional handle that can be mounted on both sides

Available for discs 115/125/230 mm in diameter, rated absorbed power ranging from 750 W to 2,400 W.

**Protection against accidental activation**

- Additional handle that can be mounted on both sides
- Tool-less disc cover (quick release)
- Spindle lock device for quick disc changes
  - Lock-on/off slide switch
  - Air vents protected against dust infiltration and providing optimal cooling performance
  - Service wrench included

**NEW**

019560011 1956 115-750W **750W**  
€ 50,00 € 40,00

**Angle grinder for discs Ø 115 mm**

Ideal for cutting, grinding and roughing jobs  
**Powerful motor (750 W)**

Nonslip ergonomic handle for increased comfort and safety  
Lowered head that allows working in confined spaces  
Extremely lightweight (**weighs no more than 1.8 kg**)

- Tool-less disc cover (quick release)
- Additional handle that can be mounted on both sides



**Technical data**

- Absorbed power: 750 W
- Voltage: 220-240 V / 50 Hz
- Disc diameter (disc not included): 115 mm
- Free speed: 11,000 rpm
- Tool spindle thread: M14
- Tangle-free cable length: 4 m
- Weight: 1.8 kg

019560125 1956 125-1400W **1400W**  
€ 98,00 € 78,00

**Angle grinder for discs Ø 125 mm**

Ideal for cutting, grinding and roughing jobs  
**Powerful motor (1400 W) - Variable speed**

Nonslip ergonomic handle for increased comfort and safety  
Lowered head that allows working in confined spaces

- Tool-less disc cover (quick release)
- Additional **anti-vibration** handle that can be mounted on both sides



**Technical data**

- Absorbed power: 1400 W
- Voltage: 220-240 V / 50 Hz
- Disc diameter (not included): 125/115 mm
- Free speed: 3,000 - 10,000 rpm
- Tool spindle thread: M14
- Tangle-free cable length: 4 m
- Weight: 2.5 kg

019560230 1956 230-2400W **2400W**  
€ 131,50 € 105,00

**Angle grinder for discs Ø 230 mm**

Ideal for complex shearing, grinding and filing jobs

**Powerful motor (2400 W)**

Nonslip ergonomic handle for increased comfort and safety

- **SOFT-START FUNCTION** for a smooth start and limiting large initial inrush of current on start-up
- **ANTI-VIBRATION**
- Spindle lock device for quick disc changes



**Technical data**

- Absorbed power: 2400 W
- Voltage: 220-240 V / 50 Hz
- Disc diameter (not included): 230 mm
- Free speed: 6,500 rpm
- Tool spindle thread: M14
- Tangle-free cable: 4 m
- Weight: 5.8 kg

018980004 **1898/K40**   
~~€ 3.560,00~~ **€ 2.860,00**

**Eco friendly, heated manual cleaning tank**

- Using the bio-active liquid included, oil and residue can be effectively removed from mechanical parts without the need for aggressive chemicals
- The bio-active liquid converts the oil and other residue into carbon dioxide and water which can be re-used again and again
- no need for specialist waste collection and disposal
- suitable for both metal and plastic parts

**EQUIPMENT:**

- Long bristle brush and connecting pipe
- Right-hand and left-hand operation function
- Perforated stainless steel grid
- Wheels with brakes
- Card with display operating temperature and low level alert

**ACCESSORIES INCLUDED:**

- 2 20-l cans of environmentally friendly liquid detergent and 2 packs of bacteria
- 2 packs of bio-active liquid



**EFFECTIVE AND ENVIRONMENTALLY FRIENDLY**

TECHNICAL DATA	
Max. pump capacity:	10 l/min
Tank capacity:	40 l
Operating temperature:	+5°C ÷ +40°C
Weight:	50 kg (when empty)

**ATTENTION**

Countries where product 1898/K40 is allowed to be distributed: Austria, Belgium, France (from 2021), Hungary, Italy, Netherlands, Poland, Portugal, Spain, United Kingdom.

**1895** 

**Ultrasonic cleaning tank with special degas function**

- Ultrasonic cleaning relies on fluid heating to effectively clean spare parts and metal pieces in general (carburetors, valves etc.)
- Digital display for temperature and cleaning time selection
- Two cleaning modes: "soft" and "normal"
- For normal cleaning, just use water at a temperature of 50/60 °C
- For more accurate cleaning, add non-foaming detergent solutions specific for ultrasonic tanks
- Using the degas mode speeds up air release throughout the tank, thereby improving ultrasonic cleaning efficiency



**1895 6**

**1895 13**

**1895 27**

Tank capacity		13 l	27 l
Drain tap	✓	✓	✓
Power	150 Watt	300 Watt	500 Watt
Heating power	300 Watt	400 Watt	500 Watt
Temperature range	0÷80°C	0÷80°C	0÷80°C
Cleaning time range	0-99 minutes	0-99 minutes	0-99 minutes
Frequency	40 kHz	40 kHz	40 kHz
Power supply	220/230V	220/230V	220/230V
Dimensions	330x180x310 mm	350x325x320 mm	530x330x380 mm

018950060 **1895 6 L**  
~~€ 551,00~~ **€ 437,00**

018950130 **1895 13 L**  
~~€ 868,00~~ **€ 691,00**

018950270 **1895 27 L**  
~~€ 1.225,00~~ **€ 975,00**

014980480 **1498/12**  
 € 468,00 € 400,00

**Portable car starter, 12V**

**TECHNICAL DATA:**

- Pickup current: 2200A
- Shoulder strap included
- Sealed lead acid battery, solid electrolyte (AGM) type



014980126 **1498/16A**  
 € 358,00 € 289,00

**Electronic multipurpose battery charger, 12-24V**

- Backlit graphic display
- Max. charging current: 16A, continuous
- Charging and charge maintenance
- Protected against polarity reversal and short circuits
- 9 charging steps
- Floating system
- SHOW ROOM function (13.8V - 12A)
- SUPPLY function (14V - 12A)
- Memory saving function (13.8V - 12A)
- Battery recovery function
- Clamp holder
- Reclining hook fastening
- Supplied accessories: cable with clamp, cable with eyelets



**16A**



**TECHNICAL DATA**

Power supply: 220-240V  
 Power: 240W  
 Charging current: 4-16A  
 Battery types: Agm - Wet - Lithium (LiFePo4)  
 Charging capacity: 5-360Ah  
 Maintenance capacity: 5-550Ah  
 Output voltage: 12-24V  
 Minimum battery voltage: 0.8V  
 Degree of protection: IP20

017600008 **1760DGT/2**   
 € 628,00 € 496,00

**Digital automotive multimeter, portable, with 2-channel oscilloscope and waveform generator**



199 mm  
 40 mm  
 98 mm



**OSCILLOSCOPE SPECIFICATIONS**

**Horizontal**  
 Bandwidth: 40MHz  
 Sampling frequency range: 250MSa/s (single channel) - 125MSa/s (double channel)  
 SEC/DIV range: 5ns/div ÷ 500s/div 1,2,5 sequence

**Vertical**  
 VOLTS/DIV range: 10mV/div ÷ 10V/div at BNC input  
 Selectable analogue, bandwidth limit, typical: 20MHz  
 Low frequency response (-3db): ≤10Hz at BNC  
 DC Gain Accuracy: ± 3% for Normal or Medium acquisition mode, 10V/div ÷ 10 mV/div

**Trigger**  
 Type: Edge  
 Mode: Auto, Normal, Single  
 Slope: Rising, Falling, Rising, & Falling  
 Source: CH1, CH2

**Input**  
 Coupling: DC, AC or GND  
 Supported probe attenuation factors: 1X, 10X, 100X, 1000X

**KIT CONTENTS:**

- multimeter tips
- 2 BNC crocodile clips for oscilloscope
- tip probe for oscilloscope (1X and 10X)
- battery charger
- nylon sheath

**TECHNICAL DATA**

Display:	2.8" colour TFT
Resolution:	320 x 240 pixels
Power supply:	100V-240V AC, 50Hz-60Hz; DC INPUT 5V DC-2A
Battery:	2 x 2600 mAh

**MULTIMETER SPECIFICATIONS**

Test: Voltage, Current, Resistance, Capacity, Diodes and On-Off  
 Max. voltage: 600V DC  
 Max. current: 10A DC  
 Max. resistance: 40MOHM  
 Max. capacity: 100uF

**NEW**

014970180 **1497TE**  
~~€ 19,20~~ **€ 15,30**

**Pliers for disconnecting electrical connectors**

The extremely thin noses allow the clips to be released without damaging the connectors.

L mm	A Max mm	Ø mm
215	63	4



014970200 **1497/C23**  
~~€ 179,00~~ **€ 144,00**

**Assortment of 23 tools for releasing electrical connectors**



440x250x70 mm

014970300 **1497/C94**  
~~€ 304,00~~ **€ 245,00**

**Assortment of 94 car testing connectors For use with main diagnostic tools**

**Assortment contents:**

- 2 t-taps
- 2 potentiometers
- 2 warning lights
- 2 SRS connectors
- 2 alligator clips
- 2 acicular probes
- 2 prods
- 2 dual banana connectors
- 4 single banana connectors
- 24 flat male terminals 0.6÷6 mm
- 12 round male terminals 1.6÷3.9 mm
- 24 flat female terminals 0.6÷6 mm
- 12 round female terminals 1.6÷3.9 mm



430x390x100 mm

**COMPLETE WITH 2 T-TAPS**

017600000 **1760PA/AC-DC**  
~~€ 274,00~~ **€ 218,50**

**Amperometric clamp and digital multimeter**

**SPECIFICATIONS**

- DC voltage: 0.1mV ÷ 600V
- AC voltage: 0.1mV ÷ 600V
- AC current: 0.01A ÷ 1000A
- DC current: 0.01A ÷ 1000A
- Resistance: 0.1Ω ÷ 40MΩ
- Capacity: 0.001nF ÷ 40 μF
- Frequency: 0.001kHz ÷ 4kHz
- Temperature: -40°C ÷ 1000 °C
- 40°F ÷ 1832°F



**500°C**

017600350 **1760/IR500**  
~~€ 127,00~~ **€ 101,50**

**Digital infrared thermometer with dual laser aiming system**

**TECHNICAL DATA**

- Temperature range: -50 ÷ 500 °C (-22 ÷ +932 °F)
- Display resolution: 0.1 °C (0.1 °F)
- Emissivity: 0.1 ÷ 1 adjustable
- Accuracy: -50 °C ÷ +20 °C (+/- 3 °C); 20 ÷ 500 °C (+/-2% or 2 °C)
- Optical resolution (D:S): 12:1
- Auto power off: ca. 10 seconds
- Operating temperature: 0 °C ÷ 50 °C
- Storage temperature: -20 °C ÷ 60 °C
- Power supply: 1 9V battery



014980014 **1498LT/12-24** ~~€ 1.415,00~~ **€ 1.137,00**

**SUITABLE FOR USE ON CARS, COMMERCIAL VEHICLES AND TRUCKS**  
**12-24 VOLT**



**Portable high-performance starter, 12-24 V, ultralightweight**

The microprocessor provides total protection against:

- polarity reversal
- short circuits
- incorrect voltage
- overloads
- underdischarge
- overcharge
- overtemperature



**UP TO 10,000A IN 5 KG WEIGHT!**



**TECHNICAL DATA**

- operating voltage: 12/24V
- continuous amperage: 2000/1000 A
- maximum starting amperage: 5000/2500 A
- peak amperage: 10000/5000 A
- clamp amperage: 1000 A
- cable length: 160 cm
- cable section: 25mm<sup>2</sup>
- automatic power supply: 4 Amp
- memory saving function

**NEW**



cable length 160 cm



014980012 **1498LT/12** ~~€ 692,00~~ **€ 557,00**

**Portable high-performance starter, ultralightweight**



Operating voltage	12V
Continuous amperage	800A
Maximum pickup amperage	2000A
Peak amperage	4000A
Cable length	500 mm
Battery type	4 cells LifePo4
Memory saving function	Yes
Dimensions:	260x135x72 mm
Complete with charging power supply 12 V 1,3A	



**4000A**

**WEIGHS NO MORE THAN 2.5 KG!**



014980000 **1498MN/12** ~~€ 284,00~~ **€ 228,50**

**Multipurpose portable starter**

- Motor vehicle starting with 12-volt battery (diesel and petrol engines up to 2,000 cc)
- Charging of tablets, mobile phones and electronic devices in general
- Multi-use LED torch



240x185x60 mm



Pickup current	600A
Battery type	5V 1A-2A
Size	190x85x35 mm
Starting output:	12 Volts

014980490 **1498/24**  
 € 902,00 € 785,00



**Portable car and commercial vehicle starter, 12-24V**

- Pickup current: 4200A (12V) - 2100A (24V)
- Sealed lead acid battery, solid electrolyte (AGM) type



017600170 **1760/RSE**  
 € 377,00 € 303,00



**Signal detector**

Allows power supply of parts to be tested, including common rail electro-injectors, petrol/LPG electro-injectors, piezoelectric injectors, flow regulating solenoid valves, EGR solenoid valves and coils

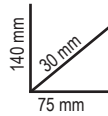

Performing diagnosis of individual parts of electric system only requires probe to be brought near part being tested. In systems with electromechanical/electronic parts controlled by a control unit, this tool makes it possible to check whether:

- control unit is being supplied with power and is performing its control function

- cables connecting control unit to part is efficient
- part being tested has not being disconnected
- part has not short-circuited
- part is operating electronically



014980401 **1498TB/12-24**  
 € 531,00 € 426,00



**Digital battery tester, 12V, and starting/charging system analyzer, 12-24V**

Allows the following to be tested: battery, alternator (smart and normal) and starter, diode ripple and chassis test

- fitted with software for printing test from PC
- compact, shockproof frame
- complete with input for connecting a removable mini printer (optional accessory, Beta 1498ST/TB)



435x320x100 mm



Applications	- 12V battery test - Alternator charge test, 12-24V - Starter test
Operating range	100-2000 CCA
Reference standards	CCA, SAE, DIN, EN, IEC, JIS
Supported batteries	PB, WET, GEL, AGM, AGM FLAT, EFB
Voltmeter	9V-36V
Cable length	1600 mm
Languages	Italian, English, French, German, Spanish, Polish, Romanian, Dutch, Swedish and Finnish
Accessories included	USB cable and software

018990010 **1899A-DPF/FAP**  
 € 986,00 € 785,00



### DPF/FAP® system cleaning machine

Special detergents can be used to periodically clean and restore DPF and FAP® systems damaged by soot and ash deposits. Results can be checked by self-diagnosis, which allows soot mass and differential pressure in diesel particulate filter before and after treatment to be determined.

COMPATIBLE WITH ANY BRAND OF DETERGENT FOR THIS TYPE OF MACHINE.



- Supplied with:
- 1 2-m-long feed pipe
  - 1 quick coupler + hose nozzle for differential sensor hoses
  - 1 niplex M18x1.5 with hose nozzle for direct connection to lambda probe
  - 1 extension hose
  - 1 DPF/FAP® spray nozzle
  - 1 magnetic pipe support
  - 1 DPF/FAP® pipe with adjustment cable gland plus niplex M14/16/18 mm for connecting lambda probes
- Technical specifications:
- operating voltage: 12 V
  - power supply cord length: 3.9 m
  - tank capacity: 1 l



**NEW**



017670100 **1767B**  
 € 116,00 € 93,50

**NEW**

### Pedal and steering wheel locking kit

The trigger adjustment mechanism ensures accurate settings when keeping the vehicle accelerated.



490x285x95 mm

014650010 **1465**  
 € 940,00 € 756,00



### Engine efficiency tester

Allows endothermic engine compression to be tested within just a few seconds, without requiring connection to engine, taking power from vehicle battery, through a dedicated software.

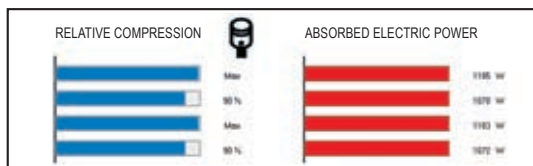

**TAKES JUST A FEW SECONDS TO TEST COMPRESSION!**

Step 1	Calculating engine rpm
Step 2	Testing battery voltage trend during each revolution
Step 3	Displaying absorbed power and compression calculated through starter operation for each piston
Step 4	Testing battery charge and efficiency

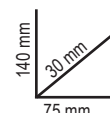

009600510 **960AD/TP2**  
~~€ 342,00~~ **€ 286,00**

**Set of adaptors for item 960TP**  
 in plastic case

- Contents:
- Dummy injectors
  - Dummy glow plugs
  - Spark plug adaptors
  - Oil cap adaptors
  - Petrol injection couplers
  - Set of spare gaskets

≡ 430x310x50 mm



1464T ✓

014640377 **1464IC-RK**  
~~€ 141,00~~ **€ 113,50**

**Universal dummy injector kit**  
 for cars, trucks, marine engines  
 and agricultural machines

Supplied with art. 1464IC

≡ 200x110x30mm



1464T ✓

014640300 **1464CBD**  
~~€ 555,00~~ **€ 446,00**

**Comprehensive adapter set for testing**  
 compression in petrol and diesel  
 engines, with tester 1464T

Makes it possible to connect to engine  
 to test petrol and diesel compression  
 with tester 1464T

Contents:

- 8 dummy spark plugs with non-return valves
- 44 dummy glow plugs with non-return valves
- 1 adjustable universal dummy injector for cars, trucks, marine engines and agricultural machines
- 1 90° adapter, pressure release valve and connecting pipe
- space accommodating tester 1464T in case

≡ 510x410x140 mm



1464T ✓

014640470 **1464FG**  
~~€ 249,50~~ **€ 201,00**

**Set of dummy regulators for**  
 testing diesel common rail system  
 (for use with Beta 1464T-1464AP)

Used with the tester and suitable adapters, it  
 makes it possible to determine whether the  
 problem is the high pressure pump or the  
 regulator when there is no pressure in the high  
 pressure circuit in common rail engines.  
 Recommended for Bosch, Delphi, Denso and  
 Siemens pressure regulators

≡ 350x250x80 mm



1464T ✓

014640050 **1464T**  
~~€ 634,00~~ **€ 510,00**

**Digital pressure**  
 and compression tester

SPECIFICATIONS

- 5" touch screen display
- rechargeable polymer lithium battery
- complete with 80 bar sensor (for low pressure) and USB cable



014640450 **1464AP**  
~~€ 559,00~~ **€ 450,00**

**Set for testing high pressure system in**  
 common rail diesel engines, with item  
 1464T



1464T ✓

≡ 430x310x50 mm

014640500 **1464APB**  
~~€ 315,00~~ **€ 254,00**

**Set for testing high pressure system**  
 in FSI petrol engines, for use with  
 item 1464T

Comes with 200 bar sensor and connectors



1464T ✓

≡ 240x210x50 mm



014640550 **1464PT**  
~~€ 136,50~~ € 110,00

**Set for testing turbo pressure, for use with item 1464T**  
 Comes with sensor and connecting cable



240x210x50 mm

014640570 **1464VD**  
~~€ 158,50~~ € 127,50

**Vacuum testing set for item 1464T**  
 For measuring and storing maximum vacuum value.  
 Supplied with:  
 • 800 mbar sensor  
 • 6 and 8 mm adaptors  
 • 3-m-long RJ45 cable



240x210x50 mm

**TECHNICAL DATA:**  
 • Vacuum test: 0÷800 mbar  
 • Resolution: 1 mbar  
 • Maximum value storage

014640600 **1464TDI**  
~~€ 96,50~~ € 78,00

**Set for testing pump pressure in TDI engines, for use with item 1464T**  
 Comes with connector

240x210x50 mm



014640610 **1464FAP**  
~~€ 158,50~~ € 127,50

**Set for testing high pressure system in common rail diesel engines, with item 1464T**

- High pressure pipe set
- Fittings
- 2,000 bar sensor

240x210x50 mm



014640620 **1464ADB**  
~~€ 73,00~~ € 59,00

**Set for testing AdBlue® system pressure for item 1464T**

Supplied with adaptors for use with 80-bar standard sensor supplied with item 1464T

240x210x50 mm



014640650 **1464PF**  
~~€ 565,00~~ € 455,00

**Set for testing pressure in braking system, for use with item 1464T**  
 Comes with adapters and connectors

400x280x60 mm



014640700 **1464PB**  
~~€ 456,00~~ € 350,00

**Set of 9 connectors for testing fuel low pressure (for use with item 1464T)**

Quick connectors to tester 1464T allow fuel low pressure in diesel and petrol engines to be quickly checked

520x440x120 mm



049000112 **CA49-G**  
~~€ 685,00~~ **€ 481,00**

Multi-purpose trolley with door, empty

049000102 **CX49-G**  
~~€ 536,00~~ **€ 426,00**

Multi-purpose trolley, empty

## MULTI-PURPOSE TROLLEY

Can be used as a mobile workstation for diagnostic tools, laptops, testers and battery chargers

- Painted sheet metal frame: unparalleled firmness and sturdiness
  - Ergonomic handle
  - 2 fixed rear castors Ø 160 mm
- 2 steering front castors Ø 125 mm (one with brake)



2-level top

2 central shelves with adjustable position and 1 fixed low shelf



Pull-out drawer for housing a mini keyboard



4 useful side cable reels made of plastic



CX49-G



2 useful side containers



1 paper holder

014820110 **1482SN**  
~~€ 41,50~~ **€ 33,00**

Quick coupler swivel pliers for fuel pipes, with articulated jaws

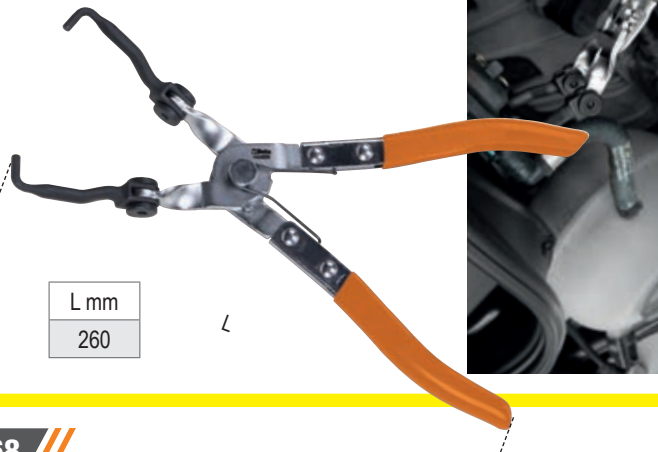

L mm

260

**NEW**

018770080 **1877A**  
~~€ 983,00~~ **€ 790,00**

Exhausted oil drain unit / vacuum cleaner, wheeled, with 90 l tank and pre-chamber

- Transparent pre-chamber: capacity 9.5 l
- 1.8-m suction pipe

Standard accessories:

- 1 hard probe, Ø 5x700 mm
- 1 flexible probe, Ø 5x700 mm
- 1 hard probe, Ø 6x600 mm
- 1 flexible probe, Ø 6x700 mm
- 1 flexible probe, Ø 7x700 mm
- 1 flexible probe, Ø 8x700 mm
- adapters for VW, BMW, CITROËN

052000201 **CB52-0**  
~~€ 551,00~~ **€ 442,00**

Gearbox/transmission trolley with liquid recovery system

Inclined plane and drain holes allow liquids to be recovered in collection tank

**CAPACITY**  
**7 L**

**kg 400**



870 mm  
640 mm  
1200 mm

Ø 100 mm

**kg 60**

Fitted with:

- 4 swivel castors, including 2 with brakes
- tool drawer
- pull-out liquid collection tank; capacity: 7 l
- 2 shelves



## OIL DRAIN UNITS

- level indicator
- big diameter pan with breakwater grate; capacity: 12 l
- pneumatic tank emptying through 1.8 m pipe

018770008 **1877**  
~~€ 558,00~~ **€ 448,00**

Exhausted oil drain unit, wheeled, with 90 l tank



017580035 **1758B-RNT**  
~~€ 22,00~~ € 17,30

**Non-return quick coupling for funnel item 1758B**  
 For Renault 1.5 dCi engine



017580030 **1758B**  
~~€ 28,50~~ € 23,10

**Non-return funnel with quick couplings**

Particularly suitable for VAG cars

**NON-RETURN**



014940325 **1494MRC** 38"  
~~€ 8,15~~ € 6,55

**Special socket for plastic oil drain plugs, for Mercedes engines**



17 mm



014940330 **1494MAN** 38"  
~~€ 8,15~~ € 6,55

**Special socket for plastic oil drain plugs, for Mercedes engines**



17 mm



014940350 **1494T/C5** 38"  
~~€ 55,50~~ € 43,50

**Set of special sockets for plastic oil drain plugs**

Set contents:

- 1 socket for VAG group oil drain plugs
- 1 socket for BMW oil drain plugs
- 1 socket for PSA and Ford group oil drain plugs
- 1 socket for Mercedes oil drain plugs
- 1 "T"-handle wrench



17 mm



173x125x50 mm

017580040 **1758B/K5**  
~~€ 79,00~~ € 63,50

**kit of non-return quick coupling adapters, for funnel 1758B**

Kit contents:

- 1 adapter for 1.5 dCi Renault, Dacia, Nissan engines
- 1 adapter for 1.5/1.6 dCi Renault, Dacia, Nissan engines
- 1 adapter for 3.0 BMW diesel engines
- 1 adapter for 1.5/2.0 petrol engines, VAG group
- 1 connecting adapter for funnel, with tap



**NEW**

014870100 **1487/K2** 38"  
~~€ 20,00~~ € 16,10

**2 sockets for radiator drain plugs**

17 mm



014930087 **1493HK**  
~~€ 20,00~~ € 16,10

**Diesel oil filter wrench for Hyundai Kia, 15-sided**



**NEW**

014930900 **1493C/ADB**  
~~€ 12,60~~ **€ 10,10**

Socket for opening AdBlue® caps, for PSA group vehicles



38"



17 mm

014930910 **1493U/ADB**  
~~€ 8,15~~ **€ 6,55**

Socket for opening AdBlue® drain plugs



38"



17 mm

009600780 **960KPC**  
~~€ 229,00~~ **€ 181,50**

Reversible impulse extractor with adjustable torque for glow plugs



420x185x60 mm

- Pneumatic extractor with adjustable torque and special sockets allow jammed glow plugs to be unscrewed, thereby minimizing damage risk
- 5 1/4" impact sockets, long series, specially designed for glow plugs: 8-9-10-11-12 mm, 2 extensions and 1 articulated joint
- 4 adjustable driving torques: 10-20-30-40 Nm
- Right-hand and left-hand adjustment

017590063 **1759HD/3**  
~~€ 420,00~~ **€ 338,00**

Cooling system seal testing and circuit filling tools

Make it possible to check circuit (pipes, joints, pumps, radiators) for leaks under pressure and quickly fill circuit, avoiding air bubble formation

600x500x140 mm



**6-MM SECTION**

**NEW**



019490050 **1949R**  
~~€ 55,50~~ **€ 44,50**

Blow gun for cleaning radiators

The 5 holes that are perpendicular to the handle allow dirt to be removed from radiators

$\pm S$ mm	L mm
6	600

017580050 **1758ADB-D**  
~~€ 28,00~~ **€ 22,50**

Non-return funnel for AdBlue®, with straight coupling

l max
1

**MAXIMUM CAPACITY 1 L**

017580060 **1758ADB-45°**  
~~€ 31,00~~ **€ 24,90**

Non-return funnel for AdBlue®, with 45° coupling

l max
1

**MAXIMUM CAPACITY 1 L**





014620235 **1462/KI**  
~~€ 1.925,00~~ **€ 1.510,00**

**Assortment of common rail diesel injector pullers**

Allows DELPHI-BOSCH-SIEMENS-DENSO injectors to be removed

- Mechanical and hydraulic operation
- Includes one 12-t hydraulic jack
- Can be directly used on vehicle with mounted engine
- Numerous adjustment options on head make it possible to work on most engines available

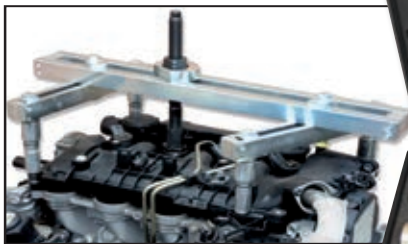

≡ 530x470x140 mm

009600801 **960KC-M8/M9/M10**  
~~€ 327,00~~ **€ 258,00**

**Assortment of tools for removing broken or damaged glow plugs**

**FOR SPARK PLUGS WITH THREADS M8-M9-M10**



≡ 380x290x50 mm

009600280 **960BC/C5** 12"   
~~€ 113,00~~ **€ 91,00**

**Set of 5 sockets for injector electric connection**

Set contents:

- 1 open hexagon socket, 25 mm
- 1 open hexagon socket, 27 mm
- 1 open hexagon socket, 29 mm
- 1 open hexagon socket, 30 mm
- 1 bi-hex socket, 28 mm

**22 mm**



≡ 280x160x55 mm

**NEW**

≡ 1,9 kg

014620110 **1462/MB**  
~~€ 224,50~~ **€ 181,00**

**Hammer face kit for removing injectors**

Kit contents:

- 1 4 kg hammer face with 400 mm rod
- 1 articulated adapter, male M10x1.5, female M22x1.5 mm
- 1 adapter, male M22x1.5, female M13x1.4 mm
- 1 adapter, male M14x1.5, female M27x1 mm
- 1 adapter, male M14x1.5, male M25x1 mm
- 1 adapter, male M14x1.5, male M27x1 mm
- 1 adapter, male M14x1.5, female M14x1.5 mm
- 1 adapter, male M14x1.5, male M20x1 mm
- 1 adapter, male M14x1.5, male M17x1 mm



≡ 500x250x80 mm

≡ 7,2 kg

NEW

009600726 **960ER**  
~~€ 43,00~~ € 36,50

Slide hammer  
 for injector washers

STEPPED  
 DRILL BIT



NEW

014720250 **1472B/RNLT**  

Double head socket, specially  
 designed for suction hose  
 clamps installed  
 on Renault engines

 9 mm



NEW

014540010 **1454P**  
~~€ 32,50~~ € 26,00

Scraper for removing  
 packing and sealant residues  
 Particularly recommended for cleaning  
 heads and flat surfaces to match



 mm	L mm	L1 mm
3,3	210	32

NEW

014810212 **1481T/C12**  
~~€ 104,00~~ € 83,50

Set of fuel line plugs  
 3 pairs of plugs with male/female  
 quick couplers for closing fuel lines.



275x220x45 mm

018840010 **1884**  
~~€ 392,00~~ € 296,00

Oil filler tool for manual and  
 automatic gearboxes and  
 differentials

- Complete with 12 adaptors for  
 direct connection
- Fitted with nonreturn valve  
 for leakage-free oil filling
  - Delivery: 70 cc per pump shot
  - Tank capacity: 7.5 l
  - Maximum permissible oil  
 viscosity: SAE 140



12 ADAPTORS

FORD	AT-101
UNIVERSAL (Bmw, Honda, Nissan...)	AT-102
VW-AUDI	AT-103
VW-AUDI-PORSCHE	AT-104
VW-AUDI-MINI COOPER	AT-105
MERCEDES	AT-106
DSG	AT-107
VW-AUDI CVT	AT-108
VOLVO	AT-109
TOYOTA-LEXUS	AT-110
SKODA	AT-111
VW Passat/Tiguan <2007	AT-112

NEW

018840200 **1884N/C8**  
~~€ 95,50~~ € 77,00

Set of 8 adapters for item 1884

- Set contents:
- 1 adapter for Infiniti, 7-speed, M8x1.0
  - 1 adapter for Honda, Hyundai, Kia 5x8x200 mm
  - 1 adapter for Skoda M18x1.5
  - 1 adapter for Mini M14x1.5
  - 1 adapter for Nissan M10x1.5
  - 1 adapter for Nissan Juke M12x1.25
  - 1 adapter for GM M12x1.75
  - 1 adapter for VAG group vehicles,  
 7-gear

200x145x40 mm



**NEW**

014380260 **1438K/DSG-2**

€ 483,00 **€ 389,00**

**Tool set for aligning 6- and 7-speed DSG clutches**

For use with 6-speed DSG and manual-shift, 7-speed DSG (series 1 and 2) and S-tronic gearboxes.



350x370x117 mm

10 kg

014380270 **1438K/PWR**

€ 332,00 **€ 267,00**

**Removal/installation tool set for Powershift dual clutch transmission**



440x400x85 mm

10 kg

014380305 **1438DCT/S**

€ 266,00 **€ 213,50**

**Tool set for aligning Ford dry dual clutches**

For clutch alignment after carrying out jobs like clutch oil seal replacement



440x400x85 mm

8 kg



014710101 **1471M/C22**  
~~€ 185,50~~ **€ 144,00**

**Pneumatic tool for pushing back and rotating right and left disc brake pistons with accessories**

in plastic case

- Automatic jack
- Thrust: 150 kg
- Operating pressure 5÷8 bar



350x310x85 mm

014660100 **1466/C5**

~~€ 100,50~~ **€ 81,00**

**Kit of 5 brake bleeding wrenches**

Kit contents:

- 5 wrenches sizes 7-8-9-10-11 mm
- 1 drain hose with check valve

260x170x50 mm

**OIL GOES INTO BUSH**



014670080 **1467T/C6**  
~~€ 235,00~~ **€ 189,00**

**Set of adapter plugs for brake fluid tanks, for use with BETA items 1467LF and 1467LF/2**

Set contents:

- 1 plug for Toyota vehicles
- 1 plug for Ford, Hyundai, Mazda, Mitsubishi, Nissan, Subaru vehicles
- 1 plug for Honda vehicles
- 1 plug for Mazda and Suzuki vehicles
- 1 plug for Nissan vehicles
- 1 brake bleeding adapter plug for European vehicles

350x240x85 mm

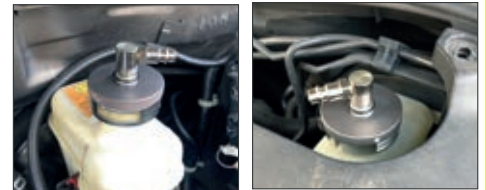

**NEW**

014710400 **1471T/C5**  
~~€ 202,50~~ **€ 163,00**

**5 slogging wrenches for truck brake calipers**

Can be used with torque wrenches

for tightening operations

Included sizes:

- female Torx wrenches E18, E20, E24
- ring wrenches M24, M26



275x220x60 mm

**NEW**

019490018 **1949GPA**  
~~€ 82,00~~ **€ 66,00**

**Tyre inflator**

- Shockproof rubber coated body
- Metal operating lever
- Operating pressure: 0,5÷12 bar, 7÷174 psi
- Pressure release feature
- Pressure measurement feature
- Pipe length: 58 cm
- 360° hose rotation
- 1/4" air inlet



**NEW**

019490021 **1949DGT/2**  
~~€ 99,00~~ **€ 79,50**

**Digital tyre inflator**

- Shockproof rubber coated body
- Metal operating lever
- Operating pressure: 0,5÷12 bar, 7÷174 psi
- 4 units of measurement, bar/psi/kpa/kgf
- Backlit LCD display
- Resolution: 0.05 bar
- Self-power off after 1.5 minutes
- Hose length: 58 cm
- 360° hose rotation
- Power supply: 2 AAA batteries
- 1/4" air inlet



**NEW**

009720010 **972/C10**

€ 233,50 **€ 188,00**

**Removal kit for damaged wheel nuts**  
For use on anti-theft and conventional nuts



290x250x60 mm

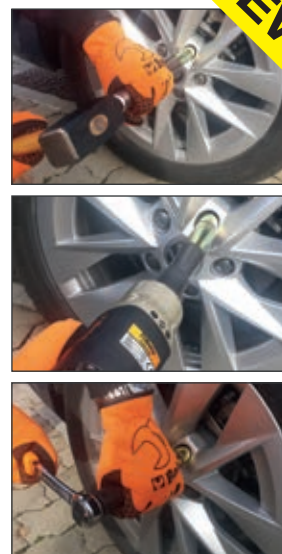

009720004 **972/C4BMW**

€ 188,50 **€ 150,00**

**Removal kit for anti-theft bolts with free rings, for BMW and Mini cars**

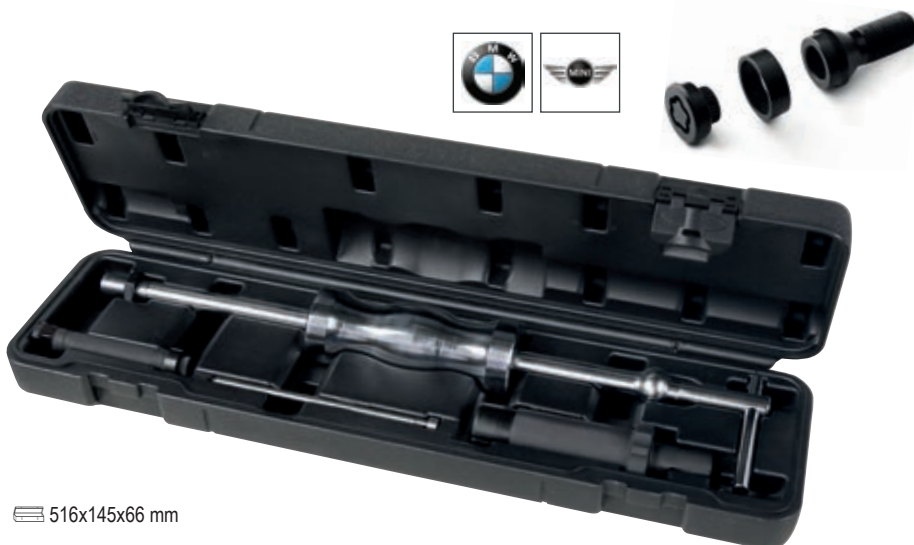

516x145x66 mm

009830010 **983PM**

€ 60,00 **€ 48,00**

**Abrasive brush for cleaning hubs**

12" 1/4"



Ø1 mm	Ø2 mm
90	150

009700011 **970IVECO**

€ 22,20 **€ 17,80**

**Hook socket for Iveco Daily hub nuts**  
For versions from year 2014

IVECO

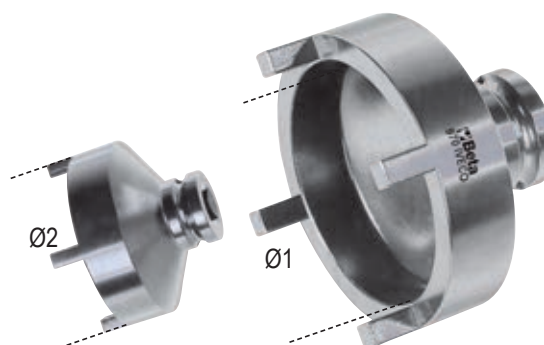

Ø1 mm	Ø2 mm
61,5	74,8

015310107 **1531/C7**  
~~€ 583,00~~ **€ 468,00**

**Removal kit for hub wheel bearing inner rings**

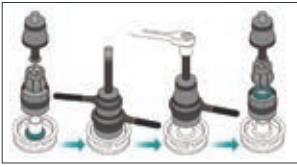

Included sizes:

- 1 pliers Ø 40÷45 mm
- 1 pliers Ø 45÷51 mm
- 1 pliers Ø 50÷55 mm
- 1 pliers Ø 55÷61 mm

390x315x96 mm

015630010 **1563/C4**   
~~€ 29,50~~ **€ 23,60**

**Set of 4 ball joint removal sockets**

 **22/24 mm**



For use with air hammer

Set contents:

- 1 socket M12x1.25 mm
- 1 socket M12x1.5 mm
- 1 socket M14x1.5 mm
- 1 socket M16x1.5 mm

009890015 **989B**  
~~€ 58,50~~ **€ 40,50**

**Combination pliers for wheel balancing weights**

Functions:

- Removing adhesive weights for alloy rims
- Removing weights for iron rims
- Hammer with removable PE-HD covering for adhesive weights and iron rims
- Weight jaws for iron rims



015680001 **1568**  
~~€ 183,00~~ **€ 147,00**

**Pneumatic assembly tool for silicone axle shaft boots**

- 8 spreader arms
- Maximum arm spreading: 145 mm

L mm	L1 mm
420	195

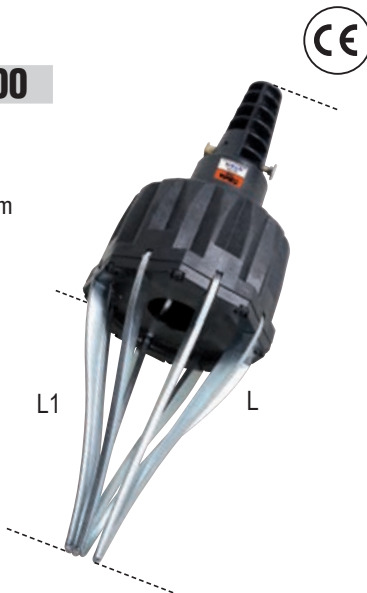

015670001 **1567**  
~~€ 268,00~~ **€ 215,00**

**Lever for removing wishbone heads and shock absorbers from pillar**

One operator can position lever effortlessly and proceed with disassembly

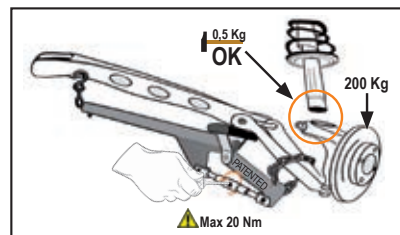
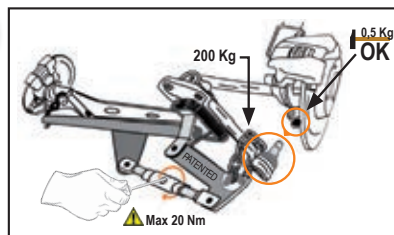

015510020 **1551/C20** 12" 5/16"   
~~€ 132,00~~ **€ 104,00**

**Kit for removing shock absorber heads**

Kit contents:

- 7 hexagon sockets, sizes: 16 - 17 - 18 - 19 - 21 - 22 - 24
- 1 socket extension, length: 120 mm
- 3 slotted female bits, sizes: 8x5 - 8x6 - 11x8
- 1 female hexagon bit, size: 10 mm
- 1 male XZN® bit, size: M10
- 1 male Torx® bit, size: T50
- 4 male hexagon bits, sizes: 5- 6 - 7 - 8
- 1 bit holder extension, length: 95 mm
- 1 bit holder extension, length: 190 mm



≡ 320x245x71 mm

015520020 **1552/C9**  
~~€ 102,50~~ **€ 81,50**

**Kit for spreading shock absorber, wishbone and steering wheel joints apart**

Working with single or double retractor head also makes it possible to work on double joints, e.g. from VAG group



≡ 195x140x40 mm

○ mm  
13

015500010 **1550U**  
~~€ 2.335,00~~ **€ 1.835,00**



**Pneumatic shock absorber removal tool for cars, SUVs and commercial vehicles**

- upper universal hold system
- active safety system on spring
- protective "full body" grille

Supplied with 2 lower forks for diameters 78-205 mm

**TECHNICAL DATA**

Maximum thrust:  
 2 tons (10 bars) - 1.6 tons (8 bars) - 1.2 tons (6 bars)  
 Spring compression stroke: 335 mm



015500018 **1550U/SS187**  
~~€ 297,00~~ **€ 238,50**

**Left-hand fork for item 1550U**  
 Particularly suitable for left-hand springs, e.g. Nissan Qashqai and Renault Koleos



015500021 **1550U/M**  
~~€ 268,00~~ **€ 215,50**

**Vice for shock absorber removal tool item 1550U**  
 Allows shock absorber stem to be locked



**MAXIMUM THRUST 2 TONS (10 BAR)**



1670 mm  
 610 mm  
 825 mm



014790150 **1479LB/C5**  
~~€ 98,50~~ **€ 71,50**  
**Kit of 5 metal trim pin removers**



215x165x50 mm

013650013 **1365/K13**  
~~€ 553,00~~ **€ 437,00**  
**Oil pressure pump, 10 t, and bodywork accessories kit in handy trolley**

**Oil pressure pump, 10 t, and bodywork accessories kit in handy trolley**

- Kit contents:
- oil pressure pump and piston
  - wing opening pliers
  - L-shaped base
  - male-to-male coupling for installing accessories



900x420x180 mm

014790604 **1479L/K4**  
~~€ 26,50~~ **€ 21,40**  
**4 wrecking bars for jobs on dashboards and delicate parts**



017660510 **1766ER/VW**  
~~€ 8,85~~ **€ 7,10**  
**Low-profile window trim removal tool**

**Low-profile window trim removal tool**

Particularly suitable for VAG group window trims with reduced grip space.

**NEW**



L mm	H mm
215	4

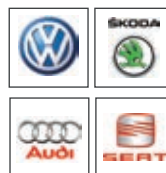

013660250 **1366B**  
~~€ 38,50~~ **€ 31,50**  
**Hammer face for plastic dent pulling glue tabs**

Hammer face weight: 500 g

L mm
440



013440100 **1344A/VW**  
~~€ 18,50~~ **€ 8,40**

**Fixing hook removal tool for Volkswagen handles**



L mm
260





017680010 **1768**  
~~€ 137,50~~ **€ 109,00**

**Aluminium footboard**

- Maximum carrying capacity: 200 kg

**SURFACE COATED WITH NON-SLIP MATERIAL**

**kg 200**



L mm	L1 mm	H mm
960	300	475



**NEW**

030090001 **3009**  
~~€ 312,00~~ **€ 251,00**

**Wheel lifter**

Maximum lifting capacity: 550 kg

- 4 pivoting rollers
- Roller width: 200 mm
- For wheels up to 240 mm in width



**IDEAL FOR:**

- **LOADING DAMAGED CARS ONTO TOW TRUCKS**
- **CAR REPAIR GARAGES**
- **MOVING CARS IN SHOWROOMS**

022540101 **2254K**  
~~€ 23,30~~ **€ 18,40**

**Reusable seat, steering wheel and gear knob protector**

Suits most car seats, steering wheels and gear knobs



**2254A**

**Car covers, for outdoor use, water-repellent and UV-resistant**

Technical specifications

- exterior finish with UV protection treatment
- soft, nonscratch interior finish
- 6 adjustment strings for making cover fit close to car
- 2 front door zips to allow access to vehicle without having to remove cover
- mirror seats
- reflecting

**THESE COVERS ARE IDEAL FOR PROTECTING DAMAGED VEHICLES WHILE WAITING TO BE REPAIRED**



022540002 **M**  
~~€ 117,00~~ **€ 94,00**

recommended for compact cars  
 4000X1450X1300 mm

022540000 **L**  
~~€ 131,00~~ **€ 104,50**

recommended for saloon cars and station wagons  
 5300X1450X1150mm

022540001 **XL**  
~~€ 119,50~~ **€ 95,50**

recommended for SUV cars  
 4700X1450X1580mm

**NEW**

# //3099E

**Outdoor motorcycle cover, water and dust resistant**

Protects paint from scratches, dust and sunlight.

- Size "M" recommended for sports and naked motorcycles and mid-size scooters
- Size "L" recommended for maxi enduro and crossover motorcycles

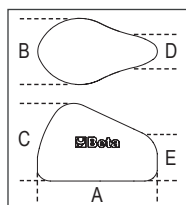
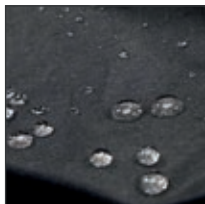

**NEW**



	Tg	A mm	B mm	C mm	D mm	E mm		€
<b>3099E/M</b>	M	2290	990	1250	350	900	030990102	<del>€ 63,00</del> <b>€ 50,00</b>
<b>3099E/L</b>	L	2500	1100	1650	1100	1500	030990103	<del>€ 77,50</del> <b>€ 62,50</b>

# //3099T

**Indoor motorcycle cover, made from stretch fabric**

Protects paint from scratches, dust and sunlight

- Size "M" recommended for sports and naked motorcycles and mid-size scooters
- Size "L" recommended for maxi enduro and crossover motorcycles
- Size "XL" recommended for super touring motorcycles

**STRETCH FABRIC**

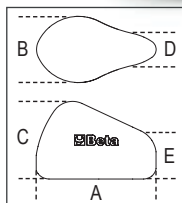

	Tg	A mm	B mm	C mm	D mm	E mm		€
<b>3099T/M</b>	M	2050	900	1000	350	800	030990202	<del>€ 55,00</del> <b>€ 43,50</b>
<b>3099T/L</b>	L	2700	1100	1300	550	1100	030990203	<del>€ 67,00</del> <b>€ 53,50</b>
<b>3099T/XL</b>	XL	3100	1300	1400	700	1200	030990204	<del>€ 81,00</del> <b>€ 64,50</b>

# // 030020001 3002

~~€ 76,50~~ **€ 61,00**

**Creepers and seat**

- Steel frame
- PVC lining with upholstery
- Easily convertible into a creeper or a seat



# DURABLE AND ERGONOMIC



030030150 **3003PRO**

€ 287,00 **€ 225,00**

**Creepers made of shockproof plastic**

Complete with:

- ergonomic head cushion
- soft back protector
- 2 double bearing castors Ø 178 mm for trouble-free use on uneven surfaces and pipes/cables
- 1 castor
- double height adjustment from the ground: 38 or 76 mm
- 2 portable LED lamps (250 lumens) with fixing magnets
- load capacity: 200 kg
- weight: 7.7 kg



**DOUBLE LED LAMP WITH MAGNET**

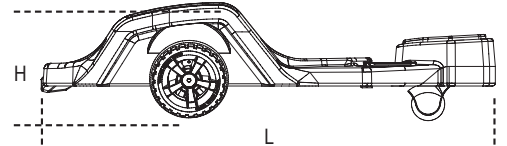
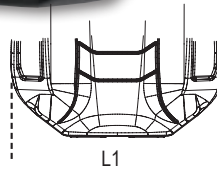

H min mm	H Max mm	L mm	L1 mm
170	230	1040	570

030030151 **3003PRO/SP**

€ 70,00 **€ 56,50**

**Wall-mounted plastic support for creeper 3003PRO**

Can be mounted to walls, bridge jacks, chests of drawers or other equipment, thereby allowing creeper to be fixed through a quick system with safety closure.



030290120 **3029L/2T**

€ 358,00 **€ 288,00**

**Long, lowered hydraulic jack, 2 t**

Makes it possible to work on vehicles with a reduced height from the ground and internal lifting point

- Controlled descent speed
- Quick approach pedal
- Nylon wheels

**MIN HEIGHT: 75 MM  
MAX HEIGHT: 530 MM**

**MAXIMUM CAPACITY:  
2 TONS**

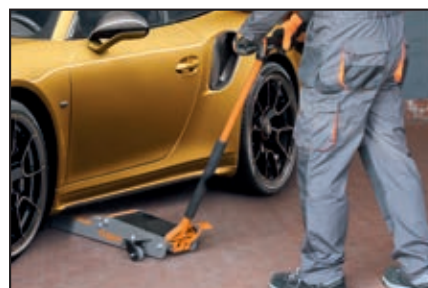

030290020 **3029/2T**

€ 317,00 **€ 254,00**

**Lowered hydraulic jack, 2 t, with 4 wheels**

- Quick approach pedal
- Steel frame and nylon wheels
- Minimum height: 75 mm

**MIN HEIGHT: 75 MM  
MAX HEIGHT: 500 MM**

**MAXIMUM CAPACITY:  
2 TONS**



030030152 **3003PRO/PM**

€ 7,30 **€ 5,90**

**Magnetic tool holder, round, for creeper item 3003PRO**

Can be applied to wheel rims of creeper to retain small items during jobs

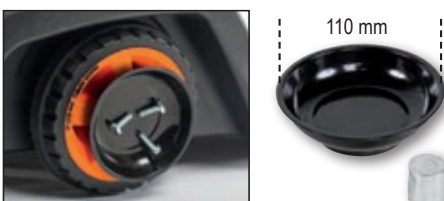

**NEW**

030330130 **3033E/3T**  
~~€ 333,00~~ **€ 268,00**



**Hydraulic jack, 3 t**

- controlled descent speed
- nylon wheels



H min-Max mm	L mm	L1 mm
95÷515	700	370

**MAXIMUM CAPACITY:  
3 TONS**

**3 T**



030300220 **3030H/2T**  
~~€ 559,00~~ **€ 448,00**



**High-lift hydraulic jack,  
2 t, with 6 wheels**

Makes it possible to work on vehicles that are high from the ground and have a long shock absorber travel

- Controlled descent speed
- Quick approach pedal
- Nylon wheels



H min-Max mm	L mm	L1 mm
85÷780	1010	300

**2 T**



030300020 **3030/2T**  
~~€ 633,00~~ **€ 507,00**



**Lowered hydraulic car jack, 2 t with  
6 wheels**

- Car jack can be easily handled on uneven, irregular floors
- Dual front tilting wheels made of plastic material (PTFE)
- Pedal allows easy approach



**MAXIMUM CAPACITY:  
2 TONS**

H min-Max mm	L mm	L1 mm
85÷520	860	400



030330030 **3033/3T**  
~~€ 846,00~~ **€ 680,00**



**Hydraulic jack, 3t long version**

- Particularly suitable for use on commercial vehicles
- Maximum capacity: 3t
- Polyamide wheels
- Length: 1180 mm
- Minimum plate height: 140 mm
- Maximum plate height: 520 mm

H min-Max mm	L mm	L1 mm
140÷520	1180	370

**MAXIMUM CAPACITY:  
3 TONS**

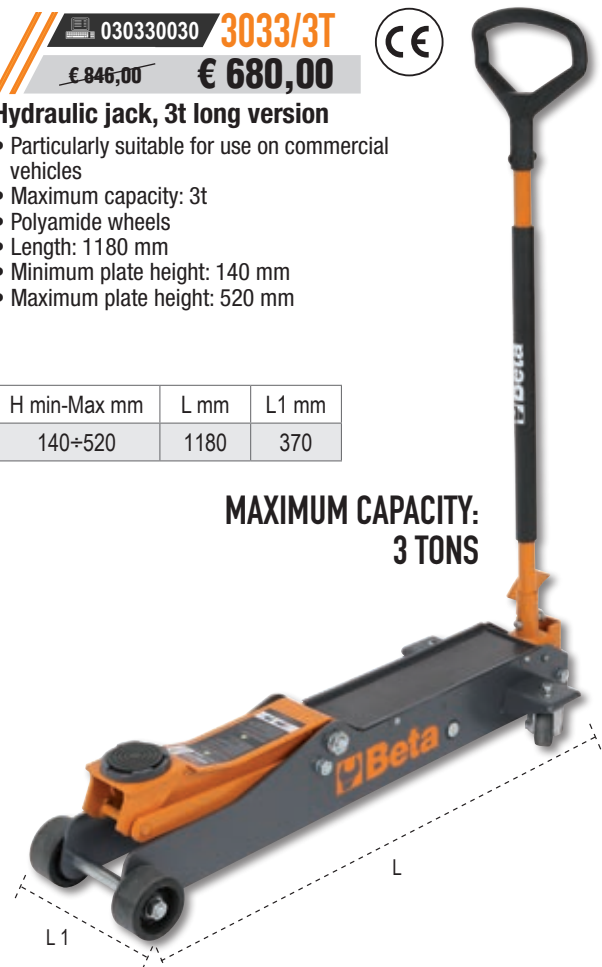

### Hydraulic bench press with moving piston

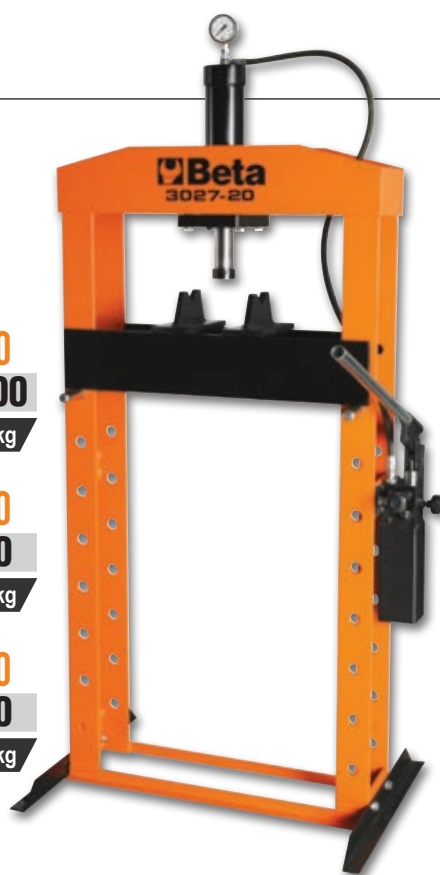

030270020 **3027 20**  
~~€ 1.845,00~~ € **1.485,00**  
 950x1900x600 mm // 140 kg

030270030 **3027 30**  
~~€ 3.340,00~~ € **2.690,00**  
 1150x1980x600 mm // 230 kg

030270050 **3027 50**  
~~€ 4.550,00~~ € **3.660,00**  
 1250x2200x700 mm // 350 kg

**3027 20    3027 30    3027 50**

Maximum capacity	20 t	30 t	50 t
Manual 2-speed pump	✓	✓	✓
Moving piston	✓	✓	✓
Hydraulic safety in case of overloading	✓	✓	✓
Manometr:	✓	✓	✓
Set of V-shaped prisms	✓	✓	✓
Gauge	x	✓	✓

030270551 **3027/KP100**  
~~€ 810,00~~ € **651,00**

**NEW**

Set of pin punches and plate for press item 3027 100  
 Pin punch Ø: 5-10-14-18-24-29 mm



030270400 **3027/PR**  
~~€ 524,00~~ € **421,00**

### Press supporting tool for removal/insertion of hubs, bearings and silent blocks

Universal system which allows user to mount/dismount hubs, bearings and silent blocks into/from their housings by operating under a press, through a supporting base and its accessories.

Tool can adapt to irregular geometric shapes of hubs/king pins on which operator must work.

Technical Data:

- Working range: min. 130 mm - max. 186 mm
- Dimensions: 300 x 300 mm
- Weight: 13 kg
- Max. load-bearing capacity: 20 t



030270100 **3027 100**  
~~€ 11.260,00~~ € **9.050,00**



### MOTORIZED ELECTRO-HYDRAULIC PRESS

#### Motorized electro-hydraulic press with moving piston

Technical specifications:

- Maximum capacity: 100 t
- Power supply: 380 V (three-phase)
- Frequency: 50 Hz
- Electric motor power: 1.5 kW
- Double speed control unit
- Operated by a lever distributor
- Pallet lifting by means of chains

Electric motor power 1,5 Kw	1,5 Kw
Control unit capacity 15,4 / 2,1 lt/1'	15,4 / 2,1 lt/1'
Piston stroke 320 mm	320 mm
Stan speed 16 / 1,5 mm/1"	16 / 1,5 mm/1"

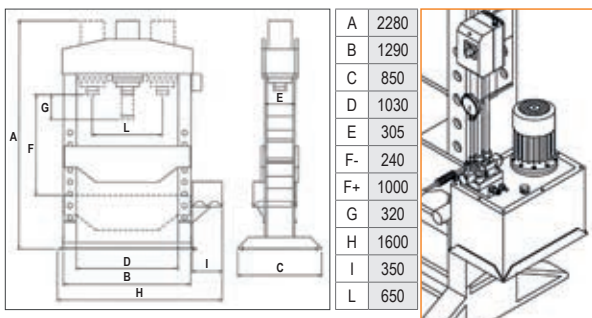

hydraulic control unit of the cylinder, comprising the following:

- electric motor
- one low-pressure and high-delivery gear pump
- one high-pressure and low-delivery piston pump
- one oil tank
- one distributor with maintained-action lever
- two pipes for connecting control unit - cylinders

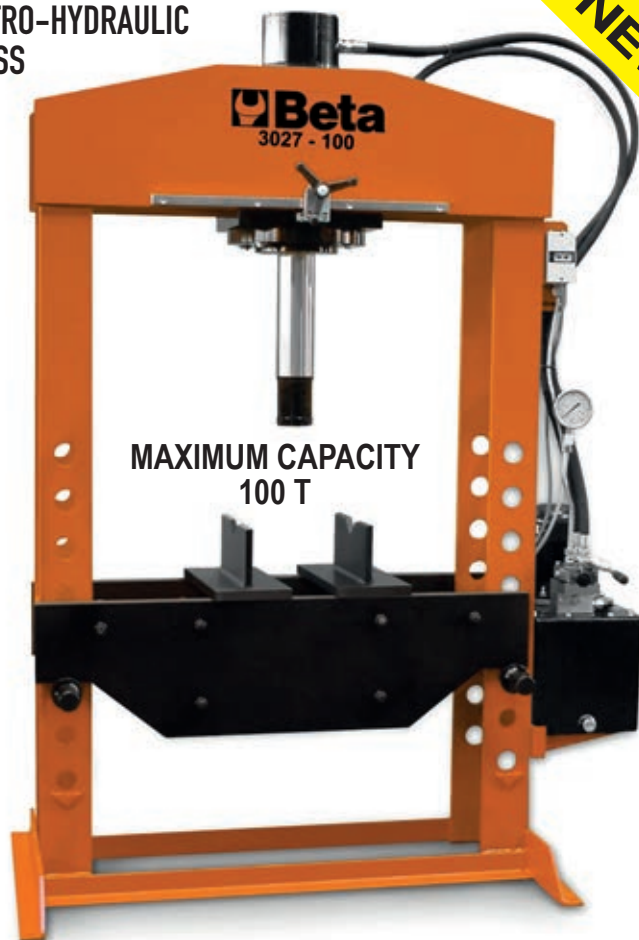

**NEW**

**MAXIMUM CAPACITY  
100 T**

CE HYDRAULIC PIT AND UNDER BRIDGE JACK

3026 0,3 3026 0,5 3026 1,0

Maximum capacity:	300 kg	500 kg	1000 kg
Pedal pump	✓	✓	✓
Min./Max. height:	1120 - 1970 mm	1140 - 1990 mm	1140 - 1990 mm
Chrome-plated stand	✓	✓	✓



030260003 **3026 0,3**  
~~€ 556,00~~ **€ 446,00**  
 // 24,7 kg

030260005 **3026 0,5**  
~~€ 657,00~~ **€ 525,00**  
 // 31 kg

030260010 **3026 1,0**  
~~€ 824,00~~ **€ 660,00**  
 // 37,8 kg



030260505 **3026/SP**  
~~€ 544,00~~ **€ 435,00**

**Universal transmission support**  
 Allows one operator to disassemble and reassemble any transmissions of cars, commercial vehicles and off-roaders quickly and safely.



// 7,8 kg

NEW

030230050 **3023**  
~~€ 164,00~~ **€ 131,00**

**Pit and under bridge jack with screw adjustment**

**MAXIMUM CARRYING CAPACITY: 400 KG**



H min-Max mm	Ø mm
1350÷2030	300



030250001 **3025**  
~~€ 1.635,00~~ **€ 1.290,00**



**Folding hydraulic crane with dual effect pump**

Maximum capacity: 1 t

- Folding frame for significantly increased compactness
- 4 loading positions: 450-650-800-1000 kg
- Controlled descent speed



1650 mm  
1000 mm  
1650 mm

// **3050/600**



**Electro-hydraulic motorcycle jack, 600 kg**

Technical specifications

- Electrical, mechanical and hydraulic safety devices
- Capacity: 600 kg
- Integrated electro-hydraulic unit: 230V - 50 Hz
- Hydraulic pump
- Controlled downward speed
- Safety fuses for protection in case of cable cuts
- control push button panel
- CE-certified, TÜV-approved



~~€ 4.730,00~~ **€ 3.680,00**

// 198 kg

Ral 2011	Ral 7016	Ral 3000
030500201	030500202	030500203

L mm	H Min mm	H Max mm
2100	185	1110

**// 8097 CE**

Lifting chain sling, 2 legs with clevis grab hooks, grade 8

**TECHNICAL DATA**

- safety factor: 4
- chain-sling identification tag
- attached certificates
- manufacturer's certificate

**// 8097SL CE**

Lifting chain slings, 2 legs, with self-locking and clevis grab hooks, grade 8

**// 080970022 8097 D7-2**  
 €147,50 € 118,50

WLL t	∅	L m
2,12	7	2

// 7,1 kg

**// 080970222 8097SL D7-2**  
 €172,50 € 139,00

WLL t	∅	L m
2,12	7	2

// 7,2 kg

**// 080970042 8097 D8-2**  
 €162,50 € 130,50

WLL t	∅	L m
2,8	8	2

// 9,1 kg

**// 080970242 8097SL D8-2**  
 €185,50 € 149,50

WLL t	∅	L m
2,8	8	2

// 9,1 kg

**// 080970052 8097 D10-2**  
 €247,50 € 199,00

WLL t	∅	L m
4,25	10	2

// 14,7 kg

**// 080970252 8097SL D10-2**  
 €290,00 € 234,00

WLL t	∅	L m
4,25	10	2

// 15 kg

**EN818-4**



**EN818-4**



**// 8143 CE**

**Hand chain blocks**

- Professional model, made of first-rate materials
- Automatic brake with double pawl system
- Swivel hook with safety latch

**// 081430005 8143 0,5T**  
 €119,00 € 96,00

WLL t	L m
0,5	3

// 9,2 kg

**// 081430010 8143 1T**  
 €141,50 € 114,00

WLL t	L m
1	3

// 11,7 kg

**// 081430020 8143 2T**  
 €206,00 € 165,50

WLL t	L m
2	3

// 19,5 kg

**EN13157**



**// 8146 CE EN13157**

**Lever hoists**

- Professional model, complies with EN13157 standard, easy to install and use.
- Automatic brake with double pawl system for optimized safety.
- Swivel hook with safety latch.

**// 081460002 8146C 0,25**  
 €135,50 € 109,00

WLL t	L m
0,25	1,5

// 2,5 kg

**// 081460008 8146 0,75 T**  
 €147,50 € 118,50

WLL t	L m
0,75	1,5

// 6,7 kg

**// 081460015 8146 1,5 T**  
 €214,50 € 172,50

WLL t	L m
1,50	1,5

// 11,2 kg

**USER-FRIENDLY, SAFE**



# //8135 CE

## Steel plate lifting clamps with articulated lifting eyes

- Professional model, compliant with EN13155, made from high-quality materials
- Suitable for lifting steel plates, rotating by 180°, and plate transportation in vertical position
- For plates with hardness up to 30HRC (300HB)
- Cam safety lock for easier steel sheet insertion and safe gripping
- Identification plate with serial number and batch number
- Safety factor: 3:1
- Minimum WLL is 10% of maximum WLL

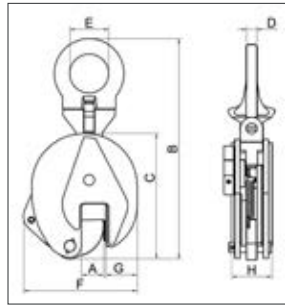

### TECHNICAL DATA

- Safety factor: 3
  - Serial number identification plate
- ### AVAILABLE CERTIFICATES
- Manufacturer's Certificate
  - CE Declaration of Conformity
  - Test report UNI EN10204 type 2.2
  - Technical product specifications



	max WLL t	A mm	kg		€	€
<b>8135 0,75 T</b>	0,75	0-15	2	081350005	€ 84,50	<b>€ 65,50</b>
<b>8135 1,0 T</b>	1,0	0-20	5	081350010	€ 111,00	<b>€ 88,50</b>
<b>8135 2,0 T</b>	2,0	0-25	8	081350020	€ 157,00	<b>€ 127,00</b>
<b>8135 3,0 T</b>	3,0	0-30	15	081350032	€ 259,00	<b>€ 214,00</b>
<b>8135 5,0 T</b>	5,0	0-50	23	081350050	€ 366,00	<b>€ 302,00</b>

max WLL (t)	Dimensions mm						
	B	C	D	E	F	G	H
0,75	205	125	10	27	105	35	40
1,0	290	170	12	48	145	45	56
2,0	375	205	17	67	175	56	56
3,0	425	237	20	75	215	60	78
5,0	480	262	20	80	232	65	90

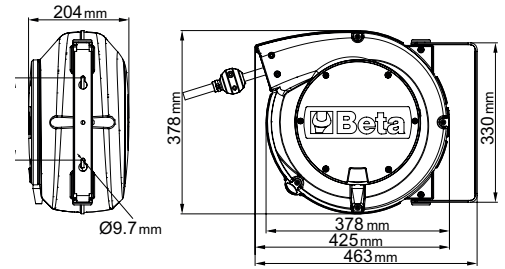
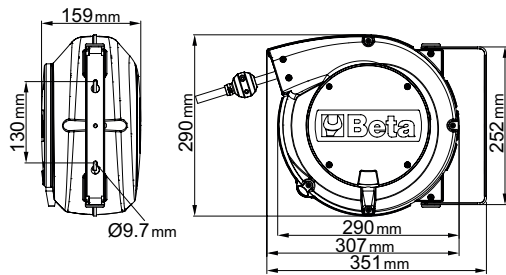

019000080 **1900S 8X10**  
€ 131,00 **€ 104,50**

## AUTOMATIC HOSE REEL

Shockproof plastic body, for air or water

- Braided polyurethane hose
- Device for automatically fixing hose at required length
- Rack mechanism can be disabled to keep hose pulled
- Water operating temperature range: -5 °C / +50 °C
- Supplied with a 180° swivel bracket and an additional quick connection bracket

019000115 **1900M 10X15**  
€ 183,50 **€ 147,50**



**1900S 8X10 1900M 10X15**

Air inlet	GAS	1/4"	3/8"
Hose length	m	10	15
Operating pressure	bar	15	15
Ø Hose	mm	8x12	10x14
Hose material		polyurethane	polyurethane

**NEW**



019270030 **1927XM** 12"  
 € 212,00 € 161,50

### Compact reversible impact wrench

- Single hammer impulse device
- Amazingly compact and powerful
- One-hand reverse button
- Three power adjustable screwing positions
- Exhaust through handle
- Balancing hook

Free speed	rpm	10.000
Impulse device		Single hammer
Max. torque	Nm	770
Bolt capacity	Cl 8.8	M22●34 mm
Bolt capacity	Cl 12.9	M18●27 mm
Air inlet	GAS	1/4"
Operating pressure	bar	6,2
Internal hose size (Ø)	mm	10
Mean air consumption	l/min	122



1,3 kg

019270129 **1927XM/K5**  
 € 250,00 € 190,00

### Assortment of 1 compact reversible impact wrench and 5 impact sockets, in plastic case



720 17-19-21-22-24 mm

307x206x86 mm

2,8 kg

019270008 **1927P** 12"  
 € 277,00 € 215,00

### Reversible impact wrench

- Double hammer impulse device
- Lightweight and well-balanced for enhanced ease of use
- Reversible lever
- Three power adjustable screwing positions
- Exhaust through handle
- Vibration-damping handle

Free speed	rpm	7.500
Impulse device		Double hammer
Max. torque	Nm	1750
Bolt capacity	Cl 8.8	M24●36 mm
Bolt capacity	Cl 12.9	M20●30 mm
Air inlet	GAS	1/4"
Operating pressure	bar	6,2
Internal hose size (Ø)	mm	10
Mean air consumption	l/min	290
weight	kg	2



2 kg

019270118 **1927P/K3** 12"  
 € 345,00 € 275,00

### Reversible impact wrench, supplied with 3 impact sockets



720LC 17-19-21 mm

350x305x86 mm

4 kg

019270007 **1927CD** 12"  
 € 244,00 € 183,50

### Reversible impact wrench

- Double hammer impulse device
- Lightweight and well-balanced for enhanced ease of use
- High torque
- Reversible lever
- Three power adjustable screwing positions
- Exhaust through handle
- Silenced

Free speed	rpm	7.000
Impulse device		Double hammer
Max. torque	Nm	1020
Bolt capacity	Cl 8.8	M22●34 mm
Bolt capacity	Cl 12.9	M18●27 mm
Air inlet	GAS	1/4"
Operating pressure	bar	6,2
Internal hose size (Ø)	mm	10
Mean air consumption	l/min	130



2,3 kg

019270107 **1927CD/K3** 12"  
 € 312,00 € 247,00

### Assortment of 1 reversible impact wrench and 3 impact sockets



720LC 17-19-21 mm

350x305x86 mm

4 kg

019270022 **1927B**  
~~€ 135,00~~ € 106,00

**Reversible impact wrench**

- "Pin Clutch" impulse device
- Rubber handle
- Reversible lever
- Three power adjustable screwing positions
- Exhaust through handle

Free speed	rpm	7.000
Impulse device		Pin Clutch
Max. torque	Nm	705
Bolt capacity	CI 8.8	M22●34 mm
Bolt capacity	CI 12.9	M18●27 mm
Air inlet	GAS	1/4"
Operating pressure	bar	6,2
Internal hose size (Ø)	mm	10
Mean air consumption	l/min	133



019270122 **1927B/K5** **NEW**  
~~€ 171,00~~ € 135,50

**Reversible impact wrench, made from aluminium, supplied with 5 impact sockets, in case**

12"

720 15-17-19 21-22 mm

350x305x86 mm

007200525 **720ME/C8** 12"   
~~€ 106,00~~ € 85,00

**8 impact socket drivers for hexagon screws**

○ 5-6-8-10-12-14-17-19 mm



270x120x45 mm

007200653 **720LC/C3** 12"   
~~€ 27,00~~ € 20,50

**3 impact sockets for wheel nuts, with polymeric inserts, in plastic case**



○ 17 - 19 - 21 mm



148x132x44 mm

007200904 **720/C24** 12"   
~~€ 253,00~~ € 203,50

**Set of 24 impact sockets, 1/2" female drive, in metal case**



Quantity/Description	Beta N.
15 10-12-13-14-15-16-17-18 19-21-22-24-27-30-32 mm	720
6 13-17-19-21-22-24 mm	720L
3 17-19-21 mm	720LC

420x185x60 mm

019280022 **1928DA** 3/4"  
~~€ 510,00~~ € 398,00

**Reversible impact wrench**

- Double hammer impulse device
- Sturdy and compact; high torque
- Reversible lever
- Three power adjustable positions
- Exhaust through handle
- Slip-proof ergonomic handle

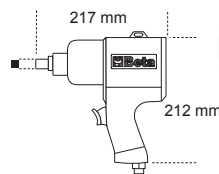

Free speed	rpm	5.000
Impulse device		Double hammer
Max. torque	Nm	1.695
Bolt capacity	CI 8.8	M30●46 mm
Bolt capacity	CI 12.9	M27●41 mm
Air inlet	GAS	3/8"
Operating pressure	bar	6,2
Internal hose size (Ø)	mm	10
Mean air consumption	l/min	210





3/4"

**ULTRA COMPACT AND POWERFUL**

**1.600 Nm!**

019280030 **1928XM**  
~~€ 431,00~~ **€ 326,00**

**Compact reversible impact wrench**

- Double hammer impulse device
- Amazingly compact and powerful
- One-hand reverse button
- Three power adjustable screwing positions
- Exhaust through handle

**2,9 kg**

Free speed	rpm	4.800
Impulse device		Double hammer
Max. torque	Nm	<b>1600</b>
Bolt capacity	Cl 8.8	M27●41 mm
Bolt capacity	Cl 12.9	M24●36 mm
Air inlet	GAS	3/8"
Operating pressure	bar	6,2
Internal hose size (Ø)	mm	10
Mean air consumption	l/min	175

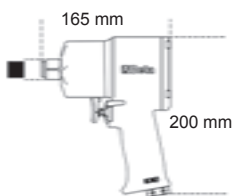

019280007 **1928CD**  
~~€ 607,00~~ **€ 477,00**

3/4"

**Reversible impact wrench**

- Double hammer impulse device
- High weight/power ratio
- Reversible lever
- Three power adjustable screwing positions
- Exhaust through handle
- Silenced



Free speed	rpm	4.500
Impulse device		Double hammer
Max. torque	Nm	<b>1.800</b>
Bolt capacity	Cl 8.8	M27●41 mm
Bolt capacity	Cl 12.9	M24●36 mm
Air inlet	GAS	3/8"
Operating pressure	bar	6,2
Internal hose size (Ø)	mm	10
Mean air consumption	l/min	215
weight	kg	3,5

**3,5 kg**

019300032 **1930PA**  
~~€ 769,00~~ **€ 603,00**

1"

**Reversible impact wrench**

- Double hammer impulse device
- Auxiliary handle
- Reversible lever
- Three power adjustable screwing/unscrewing positions
- Exhaust through handle

Free speed	rpm	3.500
Impulse device		Double hammer
Max. torque	Nm	<b>2445</b>
Bolt capacity	Cl 8.8	M36●55mm
Bolt capacity	Cl 12.9	M30●46mm
Air inlet	GAS	1/2"
Operating pressure	bar	6,2
Internal hose size (Ø)	mm	13
Mean air consumption	l/min	350
weight	kg	9,6

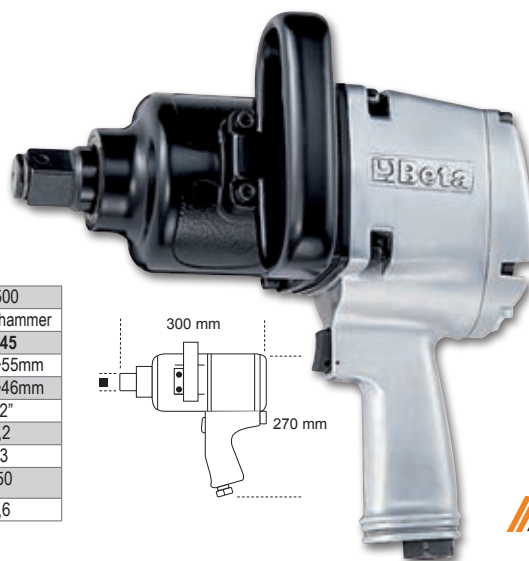

**9,6 kg**

019300030 **1930LH**  
~~€ 818,00~~ **€ 654,00**

1"

**Reversible impact wrench**

- Double hammer impulse device
- 210 mm (8.3") long anvil
- New 70-degree angled handle design to relieve stress and fatigue on the operator's wrists
- Auxiliary side handle
- 3 power adjustable screwing/unscrewing positions
- Lower exhaust



Free speed	rpm	6.000
Impulse device		Double hammer
Max. torque	Nm	<b>2.441</b>
Bolt capacity	Cl 8.8	M36 ● 55 mm
Bolt capacity	Cl 12.9	M30 ● 46 mm
Air inlet	GAS	1/2"
Operating pressure	bar	6,2
Internal hose size (Ø)	mm	13
Mean air consumption	l/min	280
weight	kg	7,1

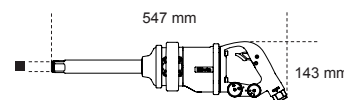

**7,1 kg**

## REVERSIBLE AIR IMPACT RATCHETS

- Double rocking dog" impulse device
- Easy tightening: The impact mechanism system eliminates wrist twisting at end of screwing and shortens operating time
- Compact and powerful: maximum torque is significantly higher than maximum torque as achieved with a conventional ratchet
- Ergonomic rubber handle

Free speed	rpm	700
Maximum torque	Nm	68
Bolt capacity	Cl 8.8	M10●16 mm
Bolt capacity	Cl 12.9	M8●13 mm
Air inlet	GAS	1/4"
Working pressure	bar	6,2
Internal hose size (Ø)	mm	10
Mean air consumption	l/min	88

019220006 **1922P1**  
~~€ 185,50~~ € 149,50

1/4"

68 Nm



164 mm

0,6 kg

019220010 **1922P2**  
~~€ 185,50~~ € 149,50

3/8"

019220013 **1922P3**  
~~€ 299,00~~ € 240,50

1/2"

136 Nm



292 mm

1,5 kg

Free speed	rpm	600
Maximum torque	Nm	136
Bolt capacity	Cl 8.8	M12●18 mm
Bolt capacity	Cl 12.9	M10●16 mm
Air inlet	GAS	1/4"
Working pressure	bar	6,2
Internal hose size (Ø)	mm	10
Mean air consumption	l/min	113

019330006 **1933IH**  
~~€ 133,50~~ € 107,50

### High-power die grinder

- Collect chuck, Ø 3 mm and 6 mm

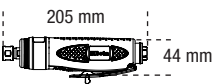

800 g

Free speed	rpm	20.000
Chuck capacity	mm	3-6
Power	kW	0,75
Air inlet	GAS	1/4"
Working pressure	bar	6,2
Internal hose size (Ø)	mm	10
Mean air consumption	l/min	370

019360025 **1936/5A**  
~~€ 262,00~~ € 210,50

### Angle grinder

- Extremely compact and handy
- Air governor for automatically controlling top speed
- Right-hand/left-hand auxiliary handle
- Spindle lock button
- Accessory for quickly changing discs
- Safety cap can be quickly adjusted in nine different positions through quick release
- Rear exhaust



Ø 125 mm

1,9 kg

Free speed	rpm	10.000
Chuck capacity	mm	125
Power	kW	0,66
Air inlet	M	14
Working pressure	GAS	1/4"
Internal hose size (Ø)	bar	6,2
Mean air consumption	mm	10
Zużycie powietrza śr.	l/min	390

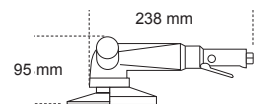

## 1937

### Roto-orbital palm sander, lubrication free, made from composite material

- No lubrication required
- Extremely compact and easy to handle
- 6-hole Velcro pad
- Continuous motor speed adjustment
- Non-slip, soft material handle
- Designed for connection to suction systems with swivel fittings
- Revolving exhaust

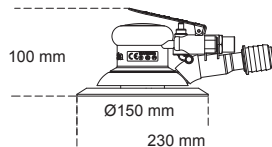

860 g

Free speed	rpm	12.000
Power	kW	0,18
Pad size	mm	150
Spindle thread		5/16"-24
Air inlet	GAS	1/4"
Operating pressure	bar	6,2
Internal hose size (Ø)	mm	10
Mean air consumption	l/min	170
weight	g	860

	Ø mm		€
1937 2.5	2,5	019370000	<del>€ 303,00</del> € 243,50
1937 5.0	5,0	019370001	<del>€ 303,00</del> € 243,50

017500111 **1750TA**  
~~€ 35,50~~ **€ 28,50**

### High-pressure, self-locking 6-pin grease nozzle

Once positioned, it remains on axis and connected to nipple; it does not have to be held like common nozzles  
 Easy to disconnect, even when with pressurized nozzle  
 Thread M10x1 : suitable for all types of grease guns: electric, pneumatic, manual etc.  
 Deformation-free up to 550 bar



019460006 **1946C4,8**  
~~€ 470,00~~ **€ 378,00**

### Automatic air suction riveter

- Professional air riveter for use with 2.4 - 3.2 - 4.0 - 4.8 mm long steel, stainless steel, aluminium and copper rivets
- Pointed cone-shaped spout
- Powerful and handy, with handle made of composite material
- Complete with safety nail container and oil gun



Material/Riveter	2,4	3,2	4	4,8
copper	✓	✓	✓	✓
aluminium	✓	✓	✓	✓
steel	✓	✓	✓	✓
stainless steel	✓	✓	✓	✓

Traction power	N	8.900
Stroke length	mm	15
Maximum rivet capacity	Ø stainless steel	4,8 mm
Air inlet	GAS	1/4"
Working pressure	bar	6,2
Internal hose size (Ø)	mm	10
Air consumption	l/cycle	2,6

**1,5 kg**

019420000 **1942A**  
~~€ 211,50~~ **€ 170,50**

### Air saw

- Powerful and handy
- Designed for cutting bodies, exhaust pipes and silencers, aluminium and plastic
- Complete with rubber handle, PVC exhaust pipe and air-feeding hose
- Rear exhaust

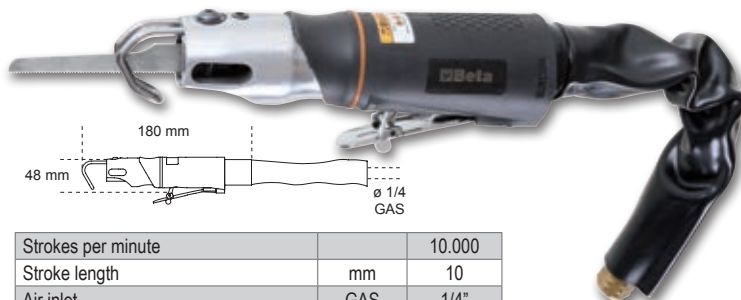

Strokes per minute		10.000
Stroke length	mm	10
Air inlet	GAS	1/4"
Operating pressure	bar	6,2
Internal hose size (Ø)	mm	8
Mean air consumption	l/min	75

**550 g**

019490030 **1949U5**  
~~€ 28,00~~ **€ 21,40**

### Progressive blow gun with 5 nozzles

- Hard-wearing, shockproof composite material body
- 3 steel nozzles, 100/160/320 mm, scratchproof, protective rubber tips
- 1 "Turbo" nozzle made of fibreglass-reinforced nylon with safety tip
- 1 revolving nozzle, 100 mm, made of fibreglass-reinforced nylon
- With quick fixing system



**934 g**

019490310 **1949P/U3**  
~~€ 28,50~~ **€ 21,70**

### Progressive mini blow gun with 3 nozzles

- Hard-wearing shockproof composite material body
- Quick nozzle fixing system
- Airflow can be adjusted through ring nut rotation
- steel nozzle, 160 mm, with scratchproof, protective rubber tip (1949U5/A)
- flat, fan-shaped nozzle, made of fibreglass-reinforced nylon (1949U5/F)
- OSHA nozzle, made of fibreglass-reinforced nylon (1949U/G)

Threaded brass insert	1/4" GAS
Working pressure	6,2 bar
Working pressure	8,3 bar
Air consumption	280 l/min
Temperature of use	-10°C ÷ 85° C



019470060 **1947G2**  
~~€ 132,50~~ **€ 106,50**

### 2-in-1 grease gun

- For continuous or non-continuous grease supply
- Die-cast aluminium head
- Ergonomic handle
- Takes 400 cc cartridges or bulk grease up to 500 cc

Hose size:	mm	54 (interior) x 276 mm
Air inlet:	GAS	1/4"
Operating pressure:	bar	3÷10



**2,2 Kg**



- CARBON FIBRE TOE CAP
- COMPOSITE FIBRE PENETRATION-PROOF INSOLE

**EN ISO 20345 2011**

**// 7353Y** 420 g  
~~€ 112,50~~ **€ 90,50**

Mesh fabric shoe, highly breathable, with TPU inserts  
 High-visibility reflective mesh upper

EU	UK	
38	5	073530038
39	6	073530039
40	6,5	073530040
41	7	073530041
42	8	073530042
43	9	073530043
44	10	073530044
45	10,5	073530045
46	11	073530046
47	12	073530047
48	13	073530048



**S1P HRO SRC**

**// 7354N** 460 g  
~~€ 88,00~~ **€ 71,00**

Mesh fabric shoe, waterproof, with TPU inserts

EU	UK	
38	5	073540038
39	6	073540039
40	6,5	073540040
41	7	073540041
42	8	073540042
43	9	073540043
44	10	073540044
45	10,5	073540045
46	11	073540046
47	12	073540047
48	13	073540048



**S3 HRO SRC**

**// 7352LG** 390 g  
~~€ 88,00~~ **€ 71,00**

Women's mesh fabric shoe, highly breathable, with TPU inserts  
 • Fibreglass toe cap  
 • Composite fibre penetration proof insole



EU	UK	
34	2	073520234
35	2,5	073520235
36	3,5	073520236
37	4,5	073520237
38	5	073520238
39	6	073520239
40	6,5	073520240
41	7	073520241
42	8	073520242



**S1P HRO SRC**

**// 7356LN** 400 g  
~~€ 90,00~~ **€ 73,00**

Women's microfibre shoe, water-repellent, with TPU inserts  
 • Fibreglass toe cap  
 • Composite fibre penetration proof insole



EU	UK	
34	2	073560234
35	2,5	073560235
36	3,5	073560236
37	4,5	073560237
38	5	073560238
39	6	073560239
40	6,5	073560240
41	7	073560241
42	8	073560242



**S3 HRO SRC**

**// 7352G** 450 g  
~~€ 87,00~~ **€ 69,50**

**NEW**

Mesh fabric shoe, waterproof, with TPU inserts

EU	UK	
38	5	073520338
39	6	073520339
40	6,5	073520340
41	7	073520341
42	8	073520342
43	9	073520343
44	10	073520344
45	10,5	073520345
46	11	073520346
47	12	073520347
48	13	073520348

**S1P HRO SRC ESD**



- CARBON FIBRE TOE CAP
- COMPOSITE FIBRE PENETRATION-PROOF INSOLE

EN ISO  
20345  
2011

**7356G** 460 g  
€ 91,50 € 74,00

O-Gravity shoe, ultralightweight,  
made of water-repellent microfibre



EU	UK	
38	5	073560038
39	6	073560039
40	6,5	073560040
41	7	073560041
42	8	073560042
43	9	073560043
44	10	073560044
45	10,5	073560045
46	11	073560046
47	12	073560047
48	13	073560048

**S3 HRO SRC**

**7356V** 460 g  
€ 91,50 € 74,00

O-Gravity shoe, ultralightweight,  
made of water-repellent microfibre



EU	UK	
38	5	073560138
39	6	073560139
40	6,5	073560140
41	7	073560141
42	8	073560142
43	9	073560143
44	10	073560144
45	10,5	073560145
46	11	073560146
47	12	073560147
48	13	073560148

**S3 HRO SRC**

**7357G** 480 g  
€ 102,00 € 82,50

O-Gravity ankle shoe,  
ultralightweight,  
made of water-repellent  
microfibre



EU	UK	
38	5	073570038
39	6	073570039
40	6,5	073570040
41	7	073570041
42	8	073570042
43	9	073570043
44	10	073570044
45	10,5	073570045
46	11	073570046
47	12	073570047
48	13	073570048

**S3 HRO SRC**

**7357V** 480 g  
€ 102,00 € 82,50

O-Gravity ankle shoe, ultralightweight,  
made of water-repellent microfibre



EU	UK	
38	5	073570138
39	6	073570139
40	6,5	073570140
41	7	073570141
42	8	073570142
43	9	073570143
44	10	073570144
45	10,5	073570145
46	11	073570146
47	12	073570147
48	13	073570148

**S3 HRO SRC**

- STEEL TOE CAP
- COMPOSITE FIBRE PENETRATION PROOF INSOLE



**7200BKK**  
~~€ 49,50~~ **€ 39,00**

Full-grain leather shoe, waterproof

EU	UK	
35	2,5	072000235
36	3,5	072000236
37	4,5	072000237
38	5	072000238
39	6	072000239
40	6,5	072000240
41	7	072000241
42	8	072000242
43	9	072000243
44	10	072000244
45	10,5	072000245
46	11	072000246
47	12	072000247
48	13	072000248

S3 SRC



**7201BKK**  
~~€ 54,00~~ **€ 42,00**

Full-grain leather ankle shoe, waterproof

EU	UK	
35	2,5	072010435
36	3,5	072010436
37	4,5	072010437
38	5	072010438
39	6	072010439
40	6,5	072010440
41	7	072010441
42	8	072010442
43	9	072010443
44	10	072010444
45	10,5	072010445
46	11	072010446
47	12	072010447
48	13	072010448

S3 SRC



**7216BKK**  
~~€ 51,50~~ **€ 40,50**

Soft suede sandal, with strap closure



EN ISO 20345 2011



EU	UK	
35	2,5	072160335
36	3,5	072160336
37	4,5	072160337
38	5	072160338
39	6	072160339
40	6,5	072160340
41	7	072160341
42	8	072160342
43	9	072160343
44	10	072160344
45	10,5	072160345
46	11	072160346
47	12	072160347
48	13	072160348

S1P SRC

**7322SA**  
~~€ 62,00~~ **€ 52,00**

Fabric shoe, highly resistant to abrasion

- Aluminium toe cap
- Composite fibre penetration-proof insole

EU	UK	
35	2,5	073220435
36	3,5	073220436
37	4,5	073220437
38	5	073220438
39	6	073220439
40	6,5	073220440
41	7	073220441
42	8	073220442
43	9	073220443
44	10	073220444
45	10,5	073220445
46	11	073220446
47	12	073220447
48	13	073220448

S3 SRC



**7323SA**  
~~€ 64,00~~ **€ 54,00**

Fabric ankle shoe, highly resistant to abrasion, with quick opening system

- Aluminium toe cap
- Composite fibre penetration-proof insole

EU	UK	
35	2,5	073230435
36	3,5	073230436
37	4,5	073230437
38	5	073230438
39	6	073230439
40	6,5	073230440
41	7	073230441
42	8	073230442
43	9	073230443
44	10	073230444
45	10,5	073230445
46	11	073230446
47	12	073230447
48	13	073230448

S3 RS SRC



NEW





**// 7220PEK**  
~~€ 46,00~~ **€ 37,00**

**Leather shoe, water-repellent, with nylon inserts and anti-abrasion reinforcement in toe cap area**

- Composite toe cap
- Composite fibre penetration-proof insole



**S3 SRC**

EU	UK	
35	2,5	072200235
36	3,5	072200236
37	4,5	072200237
38	5	072200238
39	6	072200239
40	6,5	072200240
41	7	072200241
42	8	072200242
43	9	072200243
44	10	072200244
45	10,5	072200245
46	11	072200246
47	12	072200247
48	13	072200248

**// 7221PEK**  
~~€ 48,50~~ **€ 39,00**

**Leather ankle shoe, water-repellent, with nylon inserts, anti-abrasion reinforcement in toe cap area and quick opening system**

- Composite toe cap
- Composite fibre penetration-proof insole



**S3 RS SRC**

EU	UK	
35	2,5	072210235
36	3,5	072210236
37	4,5	072210237
38	5	072210238
39	6	072210239
40	6,5	072210240
41	7	072210241
42	8	072210242
43	9	072210243
44	10	072210244
45	10,5	072210245
46	11	072210246
47	12	072210247
48	13	072210248

**// 7222PEK**  
~~€ 44,50~~ **€ 36,00**

**Suede shoe, perforated, with highly breathable mesh inserts**

- Composite toe cap
- Composite fibre penetration-proof insole



**S1P SRC**

EU	UK	
35	2,5	072220135
36	3,5	072220136
37	4,5	072220137
38	5	072220138
39	6	072220139
40	6,5	072220140
41	7	072220141
42	8	072220142
43	9	072220143
44	10	072220144
45	10,5	072220145
46	11	072220146
47	12	072220147
48	13	072220148

**EASY PLUS**

**// 7224PEK**  
~~€ 48,00~~ **€ 39,00**

**Suede shoe, perforated, with anti-abrasion reinforcement in toe cap area**

- Composite toe cap
- Composite fibre penetration proof insole



**S1P SRC**

EU	UK	
35	2,5	072240235
36	3,5	072240236
37	4,5	072240237
38	5	072240238
39	6	072240239
40	6,5	072240240
41	7	072240241
42	8	072240242
43	9	072240243
44	10	072240244
45	10,5	072240245
46	11	072240246
47	12	072240247
48	13	072240248

**// 7225PEK**  
~~€ 46,50~~ **€ 37,50**

**Suede shoe, perforated**

- Composite toe cap
- Composite fibre penetration-proof insole



**S1P SRC**

EU	UK	
35	2,5	072250135
36	3,5	072250136
37	4,5	072250137
38	5	072250138
39	6	072250139
40	6,5	072250140
41	7	072250141
42	8	072250142
43	9	072250143
44	10	072250144
45	10,5	072250145
46	11	072250146
47	12	072250147
48	13	072250148

**EASY PLUS**

**// 7238WR ENDURANCE**  
~~€ 69,50~~ **€ 54,50**

**Suede ankle shoe with nylon inserts, durable rubber outsole and quick opening system WR (water-resistant) footwear**

- Composite toe cap
- Composite fibre penetration-proof insole



**QUICK OPENING SYSTEM**

**WR**

**S3 RS WR HRO SRC**

EU	UK	
35	2,5	072380235
36	3,5	072380236
37	4,5	072380237
38	5	072380238
39	6	072380239
40	6,5	072380240
41	7	072380241
42	8	072380242
43	9	072380243
44	10	072380244
45	10,5	072380245
46	11	072380246
47	12	072380247
48	13	072380248

### //7212LG

€ 46,50 **€ 36,50**

**Women's suede shoe, perforated, with mesh inserts**

- Composite toe cap
- Composite fibre penetration-proof insole

EU	UK	
34	2	072120134
35	2,5	072120135
36	3,5	072120136
37	4,5	072120137
38	5	072120138
39	6	072120139
40	6,5	072120140
41	7	072120141
42	8	072120142

**EN ISO 20345 2011**  
**S1P SRC**



### //7214LN

€ 49,00 **€ 40,50**

**Women's suede shoe, waterproof, with anti-abrasion insert in toe cap area**

- Composite toe cap
- Composite fibre penetration-proof insole

EU	UK	
34	2	072140134
35	2,5	072140135
36	3,5	072140136
37	4,5	072140137
38	5	072140138
39	6	072140139
40	6,5	072140140
41	7	072140141
42	8	072140142

**S3 SRC**  
**EN ISO 20345 2011**



### //7241EN

€ 28,00 **€ 21,90**

**Leather shoe, water-repellent**

- Steel toe cap
- Elastic steel penetration proof insole

**EN ISO 20345 2011**

**S3 SRC**



## EASY

EU	UK	
35	2,5	072410835
36	3,5	072410836
37	4,5	072410837
38	5	072410838
39	6	072410839
40	6,5	072410840
41	7	072410841
42	8	072410842
43	9	072410843
44	10	072410844
45	10,5	072410845
46	11	072410846
47	12	072410847
48	13	072410848

### //7243EN

€ 29,00 **€ 22,70**

**Leather ankle shoe, water-repellent, with quick opening system**

- Steel toe cap
- Composite fibre penetration proof insole

EU	UK	
35	2,5	072430835
36	3,5	072430836
37	4,5	072430837
38	5	072430838
39	6	072430839
40	6,5	072430840
41	7	072430841
42	8	072430842
43	9	072430843
44	10	072430844
45	10,5	072430845
46	11	072430846
47	12	072430847
48	13	072430848

**EN ISO 20345 2011**

**S3 RS SRC**



### //7246E

€ 29,00 **€ 23,00**

**Suede shoe, perforated**

- Steel toe cap
- Composite fibre penetration proof insole

EU	UK	
35	2,5	072460435
36	3,5	072460436
37	4,5	072460437
38	5	072460438
39	6	072460439
40	6,5	072460440
41	7	072460441
42	8	072460442
43	9	072460443
44	10	072460444
45	10,5	072460445
46	11	072460446
47	12	072460447
48	13	072460448

**EN ISO 20345 2011**

**S1P SRC**



### // 7398EF

~~€ 4,70~~ € 2,95

Anatomically shaped underfoot covers made of polyurethane foam, with cushioning heel lift



EU	UK	
35	2,5	073981135
36	3,5	073981136
37	4,5	073981137
38	5	073981138
39	6	073981139
40	6,5	073981140
41	7	073981141
42	8	073981142
43	9	073981143
44	10	073981144
45	10,5	073981145
46	11	073981146
47	12	073981147
48	13	073981148



### // 7398/0-G

~~€ 4,45~~ € 3,85

Anatomically shaped underfoot covers made of EVA foam, with cushioning heel pad (spare part recommended for 0-Gravity footwear range)



EU	UK	
38	5	073981238
39	6	073981239
40	6,5	073981240
41	7	073981241
42	8	073981242
43	9	073981243
44	10	073981244
45	10,5	073981245
46	11	073981246
47	12	073981247
48	13	073981248



### // 070510001 7051MP

~~€ 5,60~~ € 3,85

Eye protector with polycarbonate visor



### // 070610001 7061TC

~~€ 5,55~~ € 4,15

Safety glasses with clear polycarbonate lenses



### // 070760009 7076BC

~~€ 12,60~~ € 9,85

Safety glasses with clear polycarbonate lenses



### // 070760019 7076BD

~~€ 12,60~~ € 9,85

Safety glasses with polycarbonate lenses



### // 070930009 7093BC

~~€ 18,00~~ € 13,80

Safety glasses with clear polycarbonate lenses



### // 070930019 7093BD

~~€ 18,00~~ € 13,80

Safety glasses with dark polycarbonate lenses



// 7650B

€ 68,00 € 55,50

Stretch work trousers, multipocket style

- Stretch fabric 90% nylon, 10% spandex, 260 g/m<sup>2</sup>
- Knee pad pockets, rear pockets and leg bottoms reinforced in polyester 600D



XS	076500100
S	076500101
M	076500102
L	076500103
XL	076500104
XXL	076500105
XXXL	076500106

SLIM FIT



BLUE

NEW

// 7816G

€ 57,50 € 42,50

Work trousers, multipocket style

- in T/C canvas 260 g/m<sup>2</sup>, grey
- Knee pad pockets and leg bottoms reinforced in polyester 600D

XS	078160000
S	078160001
M	078160002
L	078160003
XL	078160004
XXL	078160005
XXXL	078160006



// 7816BL

€ 57,50 € 42,50

Work trousers, multipocket style

- T/C canvas, 260 g/m<sup>2</sup>, blue

XS	078160100
S	078160101
M	078160102
L	078160103
XL	078160104
XXL	078160105
XXXL	078160106



- Stretch fabric 86% nylon, 14% spandex, 140 g/m<sup>2</sup>
- Knee pad pockets, rear pockets reinforced in polyester 300D
- Tearproof crotch
- Two large front pockets with zip closure

SLIM FIT NEW

// 7660G

€ 56,50 € 48,00

Stretch work trousers, lightweight, multipocket

XS	076600000
S	076600001
M	076600002
L	076600003
XL	076600004
XXL	076600005
XXXL	076600006

ANTHRACITE



// 7660B

€ 56,50 € 48,00

Stretch work trousers, lightweight, multipocket

XS	076600100
S	076600101
M	076600102
L	076600103
XL	076600104
XXL	076600105
XXXL	076600106



BLUE

- Stretch fabric 86% nylon, 14% spandex, 140 g/m<sup>2</sup>
- Rear pockets reinforced in polyester 300D
- Tearproof crotch
- Two large front pockets with zip closure

SLIM FIT

// 7661G

€ 49,00 € 40,50

Stretch work Bermuda shorts, lightweight, multipocket

XS	076610000
S	076610001
M	076610002
L	076610003
XL	076610004
XXL	076610005
XXXL	076610006



ANTHRACITE

// 7661B

€ 49,00 € 40,50

Stretch work Bermuda shorts, lightweight, multipocket

XS	076610100
S	076610101
M	076610102
L	076610103
XL	076610104
XXL	076610105
XXXL	076610106



BLUE

**//7528**  
~~€ 41,50~~ **€ 35,00**



Stretch work jeans trousers  
 98% cotton, 2% stretch fabric,  
 slim fit



**SLIM FIT**

XS	075280046
S	075280048
M	075280050
L	075280052
XL	075280054
XXL	075280056
XXXL	075280058

**//7529**  
~~€ 33,00~~ **€ 27,50**



Stretch work bermuda jeans shorts  
 98% cotton, 2% stretch fabric,  
 slim fit

**SLIM FIT**



XS	075290046
S	075290048
M	075290050
L	075290052
XL	075290054
XXL	075290056
XXXL	075290058

**//7810**  
~~€ 59,50~~ **€ 49,00**

**SLIM FIT**

"Work trekking" trousers,  
 multipocket style, HEAVY

90% nylon, 10% stretch fabric,  
 265 g/m<sup>2</sup>, anthracite grey  
 Slim cut, ergonomic fit for ease  
 of movement, bi-stretchable fabric  
 for improved comfort.  
 Reinforced inserts on knees,  
 crotch and leg bottom



**Heavy**

S	078100101
M	078100102
L	078100103
XL	078100104
XXL	078100105

**//7817N**  
~~€ 59,50~~ **€ 49,00**

**SLIM FIT**

"Work trekking" trousers,  
 multipocket style, HEAVY

90% nylon, 10% stretch fabric,  
 265 g/m<sup>2</sup>, black  
 Slim cut, ergonomic fit for  
 ease of movement and  
 bi-stretch fabric for improved  
 comfort.  
 Reinforced inserts on knees,  
 crotch and leg bottom



**Heavy**

S	078170101
M	078170102
L	078170103
XL	078170104
XXL	078170105

**// 7547BL**

~~€ 18,50~~ **€ 14,40**

Three-button polo shirt, 100% cotton, 200 g/m<sup>2</sup>, blue

XS	075470200
S	075470201
M	075470202
L	075470203
XL	075470204
XXL	075470205
XXXL	075470206

**// 7547G**

~~€ 18,50~~ **€ 14,40**

Three-button polo shirt, 100% cotton, 200 g/m<sup>2</sup>, grey

XS	075470300
S	075470301
M	075470302
L	075470303
XL	075470304
XXL	075470305
XXXL	075470306

**// 7547N**

~~€ 18,50~~ **€ 14,40**

Three-button polo shirt, 100% cotton, 200 g/m<sup>2</sup>, black

XS	075470400
S	075470401
M	075470402
L	075470403
XL	075470404
XXL	075470405
XXXL	075470406



**// 7654B**

~~€ 32,50~~ **€ 27,50**

**Stretch microfleece sweater, short-zipped**

- 95% polyester, 5% spandex, 180 g/m<sup>2</sup>, blue
- Stretch cuffs
- Chest pocket with vertical zip closure
- Polyester inserts on chest pocket and sleeves

**TOP**  
*line*



**// 7657B**

~~€ 41,50~~ **€ 34,50**

**Stretch fleece sweater, long-zipped**

- 95% polyester, 5% spandex, 280 g/m<sup>2</sup>, blue
- Stretch cuffs
- Two large waist pockets with zip closure
- Chest pocket with vertical zip closure
- Two interior pockets
- Polyester inserts on chest pocket and sleeves

**NEW**



XS	076540100
S	076540101
M	076540102
L	076540103
XL	076540104
XXL	076540105
XXXL	076540106



XS	076570100
S	076570101
M	076570102
L	076570103
XL	076570104
XXL	076570105
XXXL	076570106

NEW

7664G

€ 33,00 € 28,00

GREY



Sweatshirt, long-zipped

- 60% cotton, 40% polyester, 280 g/m<sup>2</sup>
  - Stretch cuffs
- Two large waist pockets with zip closure
- Chest pocket with vertical zip closure



TOP line

XS	076640100
S	076640101
M	076640102
L	076640103
XL	076640104
XXL	076640105
XXXL	076640106

7664N

€ 33,00 € 28,00

BLACK



XS	076640000
S	076640001
M	076640002
L	076640003
XL	076640004
XXL	076640005
XXXL	076640006

7665G

€ 36,00 € 30,50

GREY

7665N

€ 36,00 € 30,50

BLACK

XS	076650000
S	076650001
M	076650002
L	076650003
XL	076650004
XXL	076650005
XXXL	076650006

Hoodie, long-zipped

- 60% cotton, 40% polyester, 280 g/m<sup>2</sup>
  - Stretch cuffs
- Two large waist pockets with zip closure
- Chest pocket with vertical zip closure
- Fixed hood with round drawcords

TOP line

XS	076650100
S	076650101
M	076650102
L	076650103
XL	076650104
XXL	076650105
XXXL	076650106



Rainproof cap  
100% PU-coated polyester  
with water-repellent treatment



079800058 7980N L= Ø 58 CM  
€ 8,15 € 7,00

079800060 7980N XL= Ø 60 CM  
€ 8,15 € 7,00

**//7669N**  
~~€ 73,50~~ **€ 62,50**

**TOP**  
*line* **NEW**

**Stretch work jacket, lightweight, multipocket style**

- Fabric: 86% nylon, 14% spandex, 140 g/m<sup>2</sup>, black
- Water-resistant, wind-stopping, breathable and quick drying
- Detachable sleeves



XS	076690000
S	076690001
M	076690002
L	076690003
XL	076690004
XXL	076690005
XXXL	076690006

**//7659N**  
~~€ 188,50~~ **€ 90,50**

**TOP**  
*line*

**Softshell jacket with detachable hood and sleeves**

softshell jacket, 94% polyester, 6% spandex, 290 g/m<sup>2</sup>,

S	076590001
M	076590002
L	076590003
XL	076590004
XXL	076590005
XXXL	076590006



**//7979**  
~~€ 46,50~~ **€ 35,00**



**Jacket, waterproof in PVC Tricot, blue**

S	079790001
M	079790002
L	079790003
XL	079790004
XXL	079790005
XXXL	079790006



**//7970**  
~~€ 28,00~~ **€ 21,00**



**Trousers, waterproof PVC Tricot.**

Adjustable elastic waistband and waist string. Blue

XS	079700000
S	079700001
M	079700002
L	079700003
XL	079700004
XXL	079700005
XXXL	079700006



**//7579T**  
~~€ 47,50~~ **€ 39,00**

**Sleeveless work jacket, multipocket style made of waterproof 300D nylon, with stretch inserts for ease of movement, black Polyester padding, 140 g/m<sup>2</sup>**

S	075790001
M	075790002
L	075790003
XL	075790004
XXL	075790005
XXXL	075790006





## // 7930G

~~€ 43,00~~ € 32,00



### Work trousers

- 97% cotton, 3% stretch fabric, 220 g/m<sup>2</sup>
- Slim fit
- Two large front pockets
- Two rear pockets with strap closure
- Large left-side pocket with strap closure and badge insert
- Ruler pocket and hammer loop
- Knee pad inserts



**SLIM FIT**

XS	079300300
S	079300301
M	079300302
L	079300303
XL	079300304
XXL	079300305
XXXL	079300306

## // 7931G

~~€ 34,50~~ € 26,00



### Work Bermuda shorts

- 97% cotton, 3% stretch fabric, 220 g/m<sup>2</sup>
- Slim fit
- Two large front pockets

**SLIM FIT**



XS	079310300
S	079310301
M	079310302
L	079310303
XL	079310304
XXL	079310305
XXXL	079310306

## // 7935G

~~€ 75,50~~ € 56,50



### Work overalls

- 97% cotton, 3% stretch fabric, 220 g/m<sup>2</sup>
- Slim fit
- Front closure with flap-covered double tab zip
- Cuffs with strap adjusters
- Elastic waistband
- Two large front pockets
- Ruler pocket and hammer loop
- Left-side chest pocket with strap closure, badge and pen inserts
- Small right-side pocket with strap closure
- Knee pad inserts



**SLIM FIT**

XS	079350300
S	079350301
M	079350302
L	079350303
XL	079350304
XXL	079350305
XXXL	079350306

## // 7933G

~~€ 54,50~~ € 40,50

### Work overalls

- 97% cotton, 3% stretch fabric, 220 g/m<sup>2</sup>
- Slim fit
- Stretch shoulder straps, quick-release adjustment
- Large chest pocket with strap closure
- Two large front pockets
- Two rear pockets with strap closure



**SLIM FIT**

XS	079330300
S	079330301
M	079330302
L	079330303
XL	079330304
XXL	079330305
XXXL	079330306



## // 7939G

~~€ 47,50~~ € 35,50

### Work jacket

- 97% cotton, 3% stretch fabric, 220 g/m<sup>2</sup>
- Slim fit
- Front closure with flap-covered zip
- Cuffs with strap adjusters
- Two large front pockets
- Left-side chest pocket with strap closure, badge and pen inserts
- Small right-side pocket with strap closure
- Two interior pockets



**SLIM FIT**

XS	079390300
S	079390301
M	079390302
L	079390303
XL	079390304
XXL	079390305
XXXL	079390306



**7860G**  
~~€ 35,50~~ € 26,50

**Work trousers**

- T/C twill, 65% polyester, 35% cotton, 180 g/m<sup>2</sup>
- Inserts and knee pads made of "Oxford" polyester/PU, 220 g/m<sup>2</sup>
- Metal zip closure
- Two deep front pockets with small tool inserts with strap closure
- Large left-leg pocket with strap closure, mobile phone pocket and badge insert
- Large rear pockets with "Oxford" reinforcement and strap closure
- Ruler pocket and hammer loop
- Knee pad pockets

XS	078600800
S	078600801
M	078600802
L	078600803
XL	078600804
XXL	078600805
XXXL	078600806
XXXXL	078600807



**7861G**  
~~€ 31,50~~ € 23,40

**Work Bermuda shorts**

- Inserts made of "Oxford" polyester/PU, 220 g/m<sup>2</sup>
- Metal zip closure
- Two deep front pockets with small tool inserts with strap closure
- Large left-leg pocket with strap closure, mobile phone pocket and badge insert
- Large rear pockets with "Oxford" reinforcement and strap closure
- Ruler pocket and hammer loop



XS	078610800
S	078610801
M	078610802
L	078610803
XL	078610804
XXL	078610805
XXXL	078610806
XXXXL	078610807

**7869G**  
~~€ 41,50~~ € 31,00

**Work jacket**

- Inserts in "Oxford" polyester/PU, 220 g/m<sup>2</sup>
- Cuffs with strap adjusters
- Front strap closure with flap-covered double tap zip
- Adjustable waist
- Chest pockets with strap closure, pen pocket and badge insert
- Two deep waist pockets with strap closure

XS	078690800
S	078690801
M	078690802
L	078690803
XL	078690804
XXL	078690805
XXXL	078690806
XXXXL	078690807



**7865G**  
~~€ 60,00~~ € 45,00

**Work overalls**

- Inserts and knee pads made of "Oxford" polyester/PU, 220 g/m<sup>2</sup>
- Cuffs with strap adjusters
- Front strap closure with flap-covered double tap zip
- Stretch waistband
- Chest pockets with strap closure and pen pocket
- Two deep front pockets with small tool inserts with strap closure
- Large left-side pocket with strap closure, mobile phone pocket and badge insert
- Large rear pockets with "Oxford" reinforcement and strap closure
- Ruler pocket and hammer loop
- Knee pad inserts



XS	078650800
S	078650801
M	078650802
L	078650803
XL	078650804
XXL	078650805
XXXL	078650806
XXXXL	078650807

**7867G**  
~~€ 34,50~~ € 26,00

**Sleeveless work jacket**

- T/C twill, 65% polyester, 35% cotton, 180 g/m<sup>2</sup>
- Chest pockets with strap closure, pen pocket and badge insert
- Large waist pockets with strap closure

XS	078670800
S	078670801
M	078670802
L	078670803
XL	078670804
XXL	078670805
XXXL	078670806
XXXXL	078670807



**7863G**  
~~€ 45,50~~ € 34,00

**Work bib and brace overalls**

- Inserts and knee pads made of "Oxford" polyester/PU, 220 g/m<sup>2</sup>
- Metal zip closure
- Adjustable stretch shoulder straps, with quick-release snap hooks made of plastic
- Stretch waistband
- Large chest pocket with strap closure
- Two deep front pockets with small tool inserts with strap closure
- Large left-side pocket with strap closure, mobile phone pocket and badge insert
- Large rear pockets with "Oxford" reinforcement and strap closure
- Ruler pocket and hammer loop
- Knee pad pockets

XS	078630800
S	078630801
M	078630802
L	078630803
XL	078630804
XXL	078630805
XXXL	078630806
XXXXL	078630807



 **Beta**  
R5C

**NEW**

Ø67mm



ZOOM LENS EF-S 18-135

# Beta

## winning, together

### Fabio Quartararo MotoGP World Champion 2021



Partnership 2021

998015778



# Beta

Beta Utensili S.p.A. | via Volta, 18 | 20845 Sovico (MB) | tel +39 039 20771  
[www.beta-tools.com](http://www.beta-tools.com)

The images are for reference only. Beta Utensili S.p.A. reserves the right to update and upgrade its product range without notice.