

# Beta Action



Promotion valid until 30/11/2020  
Prices do not include V.A.T.

# 2020



# Beta

## RSC55



360°  
view

*Configure  
your workshop  
online*



[www.rsc55.it](http://www.rsc55.it)

# INDEX

<i>Automotive</i>	56÷79	<i>Pneumatic tools</i>	81÷90
<i>Bits</i>	33	<i>Pullers</i>	40
<i>Containers and Assortments</i>	4÷11, 17÷24	<i>Robur wire rope accessories</i>	80
<i>Cutting tools</i>	50	<i>Safety footwear</i>	91÷98
<i>Drilling and threading tools</i>	38	<i>Screwdrivers</i>	29
<i>General maintenance tools</i>	41÷49	<i>Sockets</i>	30÷32
<i>Hammers and Chisels</i>	39	<i>Thermoformed trays</i>	12÷15
<i>Insulated tools</i>	54, 55	<i>Torque wrenches</i>	34,35
<i>Male-end wrenches</i>	28	<i>Workshop equipment</i>	2,3,16
<i>Motorbike tools</i>	51÷53	<i>Workwear</i>	99÷104
<i>Pliers</i>	36, 37	<i>Wrenches</i>	25÷27

A solution for every need...

Choose the roller cab which best fits your requirements!



	RAL 2011			RAL 7016			RAL 3000											
	800 x 971 x 500 mm			800 x 1026 x 500 mm			740 x 955 x 445 mm			1050 x 973 x 565 mm			1050 x 973 x 565 mm			1035 x 970 x 445 mm		
	588 x 367 mm			588 x 367 mm			588 x 367 mm			588 x 367 mm			588 x 367 mm			882 x 367 mm		
	6	7	8	6	7	8	6	7	8	7	7	7	8	9				
70 mm - 30 kg	4	5	6	-	-	-	4	5	6	5	5	5	6	8				
75 mm - 30 kg	-	-	-	4	5	6	-	-	-	-	-	-	-	-				
140 mm - 35 kg	1	1	2	-	-	-	1	1	2	1	1	1	2	1				
150 mm - 35 kg	-	-	-	1	1	2	-	-	-	-	-	-	-	-				
210 mm - 35 kg	-	1	-	-	-	-	-	1	-	1	1	1	-	-				
225 mm - 35 kg	-	-	-	-	1	-	-	-	-	-	-	-	-	-				
280 mm - 35 kg	1	-	-	-	-	-	1	-	-	-	-	-	-	-				
305 mm - 35 kg	-	-	-	1	-	-	-	-	-	-	-	-	-	-				
	59 kg	61 kg	64 kg	69 kg	71 kg	73 kg	55 kg	58 kg	61 kg	82 kg	80 kg	84 kg	88 kg	90 kg				

## Match your assortment

5988U6/MP (214,4)			✓			✓			✓				✓	✓
5904U/MP (91,4)	✓	✓	✓	✓	✓	✓	✓	✓	✓	✓	✓	✓	✓	✓
5904VA/T (102,4)	✓	✓	✓	✓	✓	✓	✓	✓	✓	✓	✓	✓	✓	✓



## C55AP

**WORKBENCH, FOR WORKSHOP EQUIPMENT COMBINATION COMPRISED OF:**

### C55B

Bench with worktop (2050x700 mm) covered with a shockproof, non-scratch ABS coat resistant to oil and hydrocarbons.

Fitted with:

- Holes for a vice (1599F/150, to be ordered separately)
- Vertically adjustable feet

### C55M4

Fixed module with 4 drawers 588x367 mm, with ball bearing slides

- Aluminium opening system throughout length of drawer
- Drawer bases protected by foamed rubber mats
- Front centralized lock
- Can be fitted with foam trays

### C55T3

Trolley with 3 tops covered in antislip ribbed rubber

- Ergonomic handle
- Two fixing options for central worktop
- 4 castors Ø 100 mm, 2 fixed, and 2 steering with brakes
- Static load capacity: 200 kg

### C55PSP

Tool wall system with shutter and framework

- Aluminium shutter, vertically adjustable, with lock
- Removable perforated panel for holding tools

### C55AC

Self-supporting complete corner

- Worktop (700x700 mm) with legs
- 2 upper tool wall systems complete with 2 fixing shelves (670x160 mm)

### C55B/1

1-m-long extension

- Worktop (1024x700 mm) covered with a shockproof, non-scratch PVC coat resistant to oil and hydrocarbons
- Universal leg with vertically adjustable feet
- Fixed module with 7 drawers (588x367 mm) with ball bearing slides
- Self-supporting perforated panel (1024 x 1000 mm) for holding tools



**New item**

055000030 498 kg

€ 6.950,00 € 5.637,00



## 9562P2

Multilogo mat, 200x80 cm

- Particularly suitable for use with workshop equipment item C55 or under motorcycles

095620400 1,6 kg

€ 114,50 € 97,70



**New item**



**WORKBENCH, FOR WORKSHOP EQUIPMENT COMBINATION COMPRISED OF:**
**C55PRO B0/2**

**Bench with worktop**  
(2050x700 mm) covered with a shockproof, non-scratch ABS coat resistant to oil and hydrocarbons

- Holes for a vice (1599F/150, to be ordered separately)
- Vertically adjustable feet

**C55C7**

**Mobile roller cab with seven drawers** 588x367 mm, with ball bearing slides

- 4 castors Ø 100 mm, 2 fixed (one with brake) and 2 steering
- Drawer bases protected by foamed rubber mats
- Front centralized lock

**C55M7**

**Fixed module with seven drawers** 588x367 mm, with ball bearing slides

- Drawer bases protected by foamed rubber mats
- Front centralized lock

**C55PB-PRO/5**

**Workbench with tool wall system**

Supplied with framework

- Aluminium shutter, vertically adjustable, with lock
- Removable perforated panel for holding tools

055000025 346 kg

€ 5.000,00 € 4.061,00



**C55PB-PRO/5E**

**Workbench with tool wall system with shutter accommodating 2 power sockets** (not included)

- Aluminium shutter, vertically adjustable, with lock
- Removable perforated panel for holding tools
- Supplied with framework

055000026 346 kg

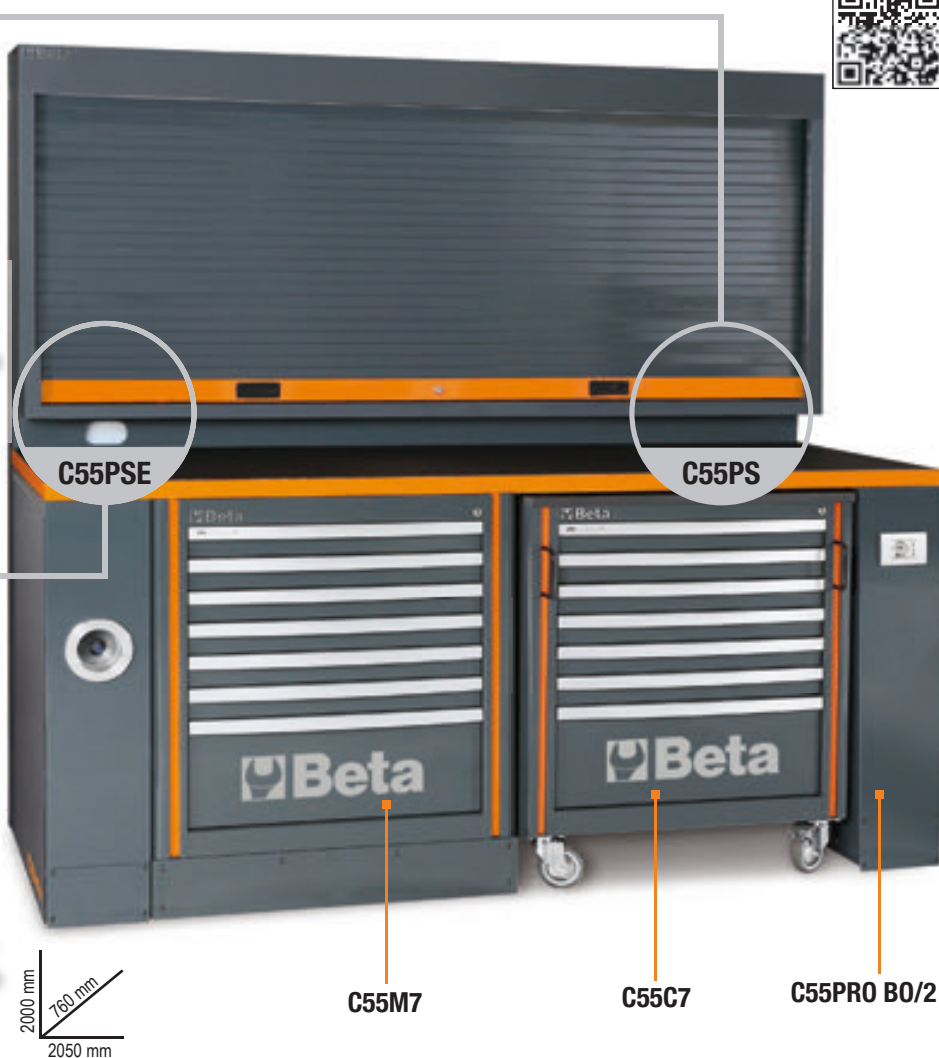
€ 5.020,00 € 4.073,00



Can be fitted with foam trays of the Beta range



Schuko socket +16+10A EU Plug 16+10A



The steering wheels allow mobile roller cab C55C7 to be easily pulled out



Compressed air outlet and roller Ø 8 mm. Length: 10 m





# C37

## Mobile roller cab

Main features:

- Sturdy multi-purpose worktop
- Quick release system made of aluminium, opening throughout length of drawer
- **Corner bumpers** throughout height of roller cab, to avoid damaging vehicles in garage
- Four castors Ø 125 mm: 2 fixed and 2 steering (one with brake)
- Tote-trays and holes for accommodating screwdrivers
- Built-in side bottle and paper holders, adjustable in several positions

*New item*



C37/6	037000061	037000062	037000063	<del>€ 693,00</del>	€ 535,00
C37/7	037000071	037000072	037000073	<del>€ 713,00</del>	€ 550,00
C37/8	037000081	037000082	037000083	<del>€ 746,00</del>	€ 576,00



# C37A/7

Mobile roller cab with 7 drawers  
With anti-tilt system

*New item*



**Anti-tilt system**



C37A/7	037000271	037000272	037000273	<del>€ 796,00</del>	€ 606,00
--------	-----------	-----------	-----------	---------------------	----------





**New item**

**C37**

**3700/PLA**

Stainless steel worktop



037000100 2,8 kg  
~~€ 44,00~~ **€ 34,60**

672x396x1,5 mm

**3700/PLL**

Wood worktop



037000101 3,9 kg  
~~€ 53,50~~ **€ 41,70**

672x396x28 mm

**3700/PF**

Perforated panel with brackets



650x626x80 mm

037000102 3,2 kg  
~~€ 42,00~~ **€ 33,10**

**3700/PFL**

Perforated side panel



754x321x38 mm

037000104 1,9 kg  
~~€ 23,80~~ **€ 18,60**

**3700/PC**

Computer bracket



418x303x399 mm

037000103 3,1 kg  
~~€ 58,00~~ **€ 45,50**

**C39**

Mobile roller cab

- Four castors with steel cores, Ø 125 mm: 2 fixed and 2 steering (one with brake)
- Front centralized safety lock



Sturdy multi-purpose worktop with tote-trays and holes for accommodating screwdrivers



Pull-out drawer with opening system throughout its length

**Uprights and drawer front made of aluminium alloy + STURDINESS + LIGHTWEIGHTNESS**

Built-in side and rear bottle and paper holders.



C39/6	039000031	039000032	039000033	<del>€ 1.103,00</del>	<b>€ 851,00</b>
C39/7	039000001	039000002	039000003	<del>€ 1.149,00</del>	<b>€ 886,50</b>
C39/8	039000041	039000042	039000043	<del>€ 1.215,00</del>	<b>€ 937,00</b>





## C24S

### Mobile roller cab

- Four castors with steel cores, Ø 125 mm: 2 fixed and 2 steering (one with brake)
- Front centralized safety lock
- Can accommodate paper roll holder item 2400S-R/PC, to be ordered separately



Pull-out drawer with quick release system made of fibreglass-reinforced nylon, opening throughout length of drawer



Sturdy ABS worktop

Built-in side bottle holder



C24S/5	024002051	024002052	024002053	<del>€ 557,00</del>	€ 429,50
C24S/6	024002061	024002062	024002063	<del>€ 564,00</del>	€ 435,00
C24S/8	024002081	024002082	024002083	<del>€ 613,00</del>	€ 473,00



## C24SA-XL

### Mobile roller cab with anti-tilt system, long model

- Four castors with steel cores, Ø 125 mm: 2 fixed and 2 steering (one with brake)
- Front centralized lock
- Can accommodate paper roll holder item 2400S-R/PC, to be ordered separately

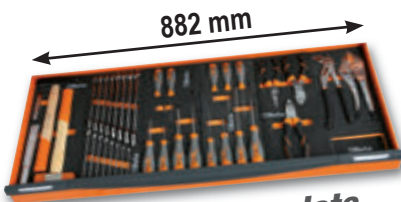

Can accommodate up to 6 thermoformed trays in one drawer

ABS worktop, with 6 tote-trays  
Sturdy nylon front, with built-in label holder

Built-in side bottle holder



C24SA-XL/7	024002271	024002272	024002273	<del>€ 833,00</del>	€ 651,00
C24SA-XL/8	024002281	024002282	024002283	<del>€ 903,00</del>	€ 697,00
C24SA-XL/9	024002331	024002332	024002333	<del>€ 938,00</del>	€ 724,00



Anti-tilt system



## C24SL-CAB

### Mobile roller cab with 7 drawers and tool cabinet

- Four castors with steel cores, Ø 125 mm:  
2 fixed and 2 steering (one with brake)
- Front centralized lock

Multi-ply wood worktop with holes for a vice (1599F/100, to be ordered separately)



C24SL-CAB

024002191

024002192

024002193

~~€ 882,00~~

€ 680,50



## C24SL

### Mobile roller cab with 7 drawers and side tops

- 7 drawers (588x367 mm) with ball bearing slides:  
5 drawers, 70 mm high  
1 drawer, 140 mm high  
1 drawer, 210 mm high
- Drawer bases protected by foamed rubber mats
- Four castors 125 mm in Ø:  
2 fixed and 2 steering (two with brakes)
- Front centralized safety lock
- Side compartment with vertically adjustable top
- Integrated paper roll holder
- Double rear bottle holder

Multi-ply wood worktop with holes for a vice (1599F/100, to be ordered separately)



C24SL

024002101

024002102

024002103

~~€ 865,00~~

€ 676,00





## C28

### SuperTank trolley with worktop and 10 drawers

- 5 side drawers
- 5 front drawers
- Drawer bases protected by foamed rubber mats
- 4 high-capacity castors 150 mm in Ø:  
2 fixed and 2 steering (with brakes)
- 2 centralised safety locks

Multiply wood worktop with holes for a vice (1599F/150, to be ordered separately)

n°	h	max
8	70 mm	25 kg
2	210 mm	30 kg



130 kg

C28    028000301    028000302    028000303    ~~€ 1.730,00~~    € 1.405,50



*New item*

### 2400-COVER C24S

Nylon cover for  
• C24S  
• C24SA  
• C39



024000910  
~~€ 14,50~~    € 11,40

### 2400-COVER C24SA-XL

Nylon cover for  
• C24SA/XL  
• C24SL  
• C24SL-CAB



024000930  
~~€ 19,30~~    € 15,10

### 3700-COVER C37

Nylon cover for  
• C37



037000930  
~~€ 19,80~~    € 15,50

### 4100-COVER C41H

Nylon cover for  
• C41H



041000930  
~~€ 15,20~~    € 11,90



# C54S

## Cargo tool cabinets

These tool cabinets are designed according to detailed research and offer accurate, comfortable and rational solutions for end users. Two perforated panels attached to the doors may be opened giving access to additional storage space.

Main features:

- 1 drawer, with slides
- Easy tool layout according to users' needs
- Easy wall mounting by means of two slots located at the back of the cabinet
- Safety lock for both drawers and doors
- Empty thermoformed tray for 1/2" sockets and accessories



1555 mm

**New item**



980 mm

303 mm

796 mm

37 kg



C54S

054000301

054000302

054000303

€ 427,00

€ 333,40



# C04TSS/7

## Mobile roller cab with seven drawers, made of stainless steel

- Four castors with steel cores, Ø 125 mm: 2 fixed and 2 steering (with brakes);
- Front centralized lock;
- Frame made entirely of stainless steel
- Castors, supports, ball bearings, drawer interiors and guides made of stainless steel
- Drawer handles made of aluminium



16 - 22 - 25 - 30 - 37



kg  
700

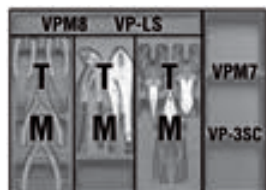

**Non-marking wheels**

n°	h	max
6	83 mm	25 kg
1	170 mm	30 kg



935 mm

470 mm

680 mm



024003077

63 kg

€ 1.665,00

€ 1.351,50



5988U6/MP

Assortment of 214 tools  
in soft foam tray



Recommended for use in combination with mobile roller cabs:  
C24S-C24SL-C37-C39-C28-C24SLCAB-C59-RSC55

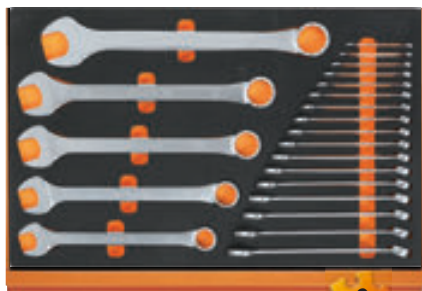

M10

22



M30

31



M210

25



M230

25

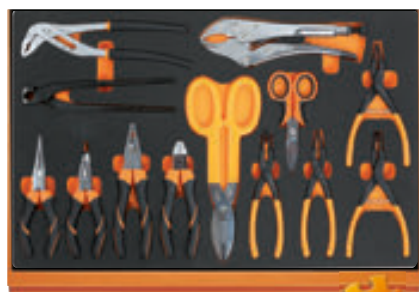

M130

13

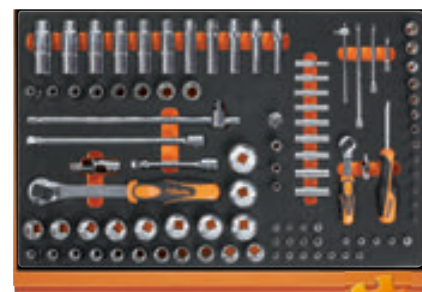

M100

98

N. Quantity/Description

- 22 combination wrenches 6-7-8-9-10-11-12-13-14-15-16-17-18-19-20-21-22-24-27-30-32-36 mm
- 11 double open end wrenches 6x7-8x9-10x11-12x13-14x15-16x17-18x19-20x22-21x23-24x27-30x32 mm
- 11 double ended offset ring wrenches 6x7-8x9-10x11-12x13-14x15-16x17-18x19-20x22-21x23-24x27-30x32 mm
- 9 ball head offset hexagon key wrenches  
Ø 1,5-2-2,5-3-4-5-6-8-10 mm
- 6 screwdrivers for cross head Phillips® screws  
● 2,5x50-3x75-4x100-5,5x125-6,5x150-8x200 mm
- 1 screwdrivers for slotted head screws, extra-short series  
● 4x30 mm
- 4 screwdrivers for cross head Phillips® screws  
⊕ PH0x60-PH1x80-PH2x100-PH3x150 mm
- 1 screwdrivers for cross head Phillips® screws, extra-short series  
⊕ PH1x30 mm
- 12 drivers for Torx® head screws, with handles  
⊙ T6-T7-T8-T9-T10-T15-T20-T25-T27-T30-T40-T45
- 1 mains testing screwdriver ●
- 3 drift punches Ø 2-3-4 mm
- 6 pin punches Ø 2-3-4-5-6-8 mm
- 1 centre punch Ø 4 mm
- 1 flat chisels 150 mm
- 2 flat chisels, ribbed type 200-250 mm
- 1 cape chisels, standard type 125 mm
- 1 engineer's hammer 500 g
- 1 soft face hammer Ø 35 mm
- 1 measuring tape 3 m
- 1 telescopic magnet with flexible head
- 1 second-cut square files 200 mm
- 1 second-cut triangular files 200 mm
- 1 second-cut flat files 200 mm
- 1 second-cut half-round files 200 mm
- 1 second-cut round files 200 mm
- 1 brake shoe cleaning brush plastic handle steel wires
- 1 snap - off blade utility knife 18 mm

Beta N.	TR
42	M10
55	M30
90	M30
96BPC/SC9	M30
1201	M210
1201N	M210
1202	M210
1202N	M210
1207TX	M210
1253	M210
30	M230
31	M230
32	M230
34	M230
35	M230
36	M230
1370	M230
1390	M230
1692	M230
1712TF	M230
1719BMA...Q	M230
1719BMA...T	M230
1719BMA...P	M230
1719BMA...M	M230
1719BMA...R	M230
1737NX	M230
1771	M230

N. Quantity/Description

- 1 circlip pliers straight, internal ○ 180 mm
- 1 circlip pliers bent, internal ○ 170 mm
- 1 circlip pliers straight, external ● 175 mm
- 1 circlip pliers bent, external ● 175 mm
- 1 slip joint pliers boxed joints 250 mm
- 1 self - locking pliers 240 mm
- 1 diagonal cutting nippers ✂ 160 mm
- 1 construction worker's pincers 220 mm
- 1 tin snips 250 mm
- 1 electrician's scissors, straight blades
- 1 half-round needle nose pliers = 180 mm
- 1 extra long needle knurled nose pliers, bi-material handles  
● 160 mm
- 1 bent needle nose pliers ● 160 mm
- 1 socket holder
- 1 socket holder
- 1 socket holder
- 13 1/4" hexagon sockets ○ 4-4,5-5-5,5-6-7-8-9-10-11-12-13-14 mm
- 9 hexagon hand sockets, long series ○ 5-6-7-8-9-10-11-12-13 mm
- 5 1/4" socket drivers for hexagon screws ○ 3-4-5-6-7 mm
- 4 socket drivers for slotted head screws  
● 0,8x4-1x5,5-1,2x6,5-1,2x8 mm
- 4 socket drivers for cross head Phillips® screws  
⊕ PH1-PH2-PH3-PH4
- 7 socket drivers for Torx® head screws  
⊙ T10-T15-T20-T25-T27-T30-T40
- 1 1/4" drive extension bar 50 mm
- 1 1/4" drive extension bar 100 mm
- 1 1/4" drive extension bar 150 mm
- 1 1/4" drive universal joint
- 1 1/4" drive spinner handle
- 1 1/4" drive swivel T-handle
- 1 1/4" reversible ratchet ⊕
- 21 1/2" square drive hexagon sockets ○ 8-10-11-12-13-14-15-16-17-18-19-20-21-22-23-24-26-27-28-30-32 mm
- 1 adaptor, 1/2" female and 3/8" male drives 125 mm
- 1 1/2" drive universal joint 250 mm
- 1 1/2" wobble extension bar
- 1 1/2" wobble extension bar
- 1 1/2" drive sliding T-handle
- 1 1/2" drive reversible ratchet ⊕
- 8 1/2" sockets for Torx® head screws  
⊙ 10-12-14-16-18-20-22-24 mm
- 11 hexagon hand sockets ○ 10-12-13-14-15-16-17-18-19-21-22 mm

Beta N.	TR
1032	M130
1034	M130
1036	M130
1038	M130
1048	M130
1052	M130
1082BM	M130
1098	M130
1112	M130
1128BM	M130
1150BM	M130
1166BM	M130
1168BM	M130
895/1	M100
895/3	M100
895/6	M100
900	M100
900L	M100
900ME	M100
900LP	M100
900PH	M100
900TX	M100
900/20	M100
900/20L	M100
900/21	M100
900/25	M100
900BG/30	M100
900/42	M100
900/55	M100
920A	M100
920/15	M100
920/25	M100
920AN/125	M100
920AN/250	M100
920/42	M100
920/55	M100
920FTX	M100
920AL	M100

059880535

24 kg

€ 1.765,00 € 1.451,00





# 5904U/MP



Assortment of 91 tools  
in soft foam tray

Recommended for use in combination with mobile roller cabs:  
C24S-C24SL-C37-C39-C28-C24SLCAB-C59-RSC55



**N. Quantity/Description**

- 16 combination wrenches 6÷21 mm
- 8 double open end wrenches 6x7 - 8x9 - 10x11 - 12x13 - 14x15 - 16x17 - 18x19 - 20x22 mm
- 9 offset hexagon key wrenches  
Ø 1,5 - 2 - 2,5 - 3 - 4 - 5 - 6 - 8 - 10 mm
- 7 screwdrivers for cross head Phillips® screws ● 2,5x50 - 3x75 - 3,5x100 - 4x125 - 5,5x100 - 5,5x150 - 6,5x150 mm
- 6 screwdrivers for cross head Phillips® screws ⊕ PH0x60 - PH0x100 - PH1x80 - PH1x120 - PH2x100 - PH2x150 mm
- 8 offset hexagon key wrenches Ø 2-2,5-3-4-5-6-7-8 mm
- 1 1/2" wobble extension bar 125 mm
- 1 1/2" wobble extension bar 250 mm
- 1 1/2" drive universal joint
- 1 1/2" drive sliding T-handle

Beta N.	TR
42	M15
55	M33
96/SC9	M33
1260	M199
1262	M202
96T	M50
920AN/125	M83
920AN/250	M83
920/25	M83
920/42	M83

**N. Quantity/Description**

- 1 1/2" drive reversible ratchet ⊕
- 19 1/2" square drive hexagon sockets  
Ø 10÷24 - 26 - 27 - 30 - 32 mm
- 1 heavy duty diagonal cutting nippers ✂ 160 mm
- 1 half-round needle nose pliers = 180 mm
- 1 screwdrivers for slotted head screws ● 160 mm
- 1 Slip joint pliers boxed joints 250 mm
- 1 self - locking pliers 240 mm
- 2 flat chisels, ribbed type 100 - 200 mm
- 1 engineer's hammer 300 g
- 1 soft face hammer Ø 35 mm
- 1 circlip pliers straight, internal ⊖ 180 mm
- 1 circlip pliers bent, internal ⊖ 170 mm
- 1 circlip pliers straight, external ● 175 mm
- 1 circlip pliers bent, external ● 175 mm

Beta N.	TR
920/55	M83
920A	M83
1084	M132
1150	M132
1166	M132
1048	M153
1052	M153
35	M234
1370	M234
1390	M234
1032	M145
1034	M145
1036	M145
1038	M145

059040425 12 kg  
€ 752,00 € 655,30



# 5904VA/T



Assortment of 102 tools  
in foam trays

Recommended for use in combination with mobile roller cabs:  
C24S-C24SL-C37-C39-C28-C24SLCAB-C59-RSC55



**N. Quantity/Description**

- 21 combination wrenches 6-7-8-9-10-11-12-13-14-15-16-17 - 18-19-20-21-22-24-27-30-32 mm
- 8 double open end wrenches  
6x7-8x9-10x11-12x13-14x15-16x17-18x19-20x22 mm
- 9 offset hexagon key wrenches Ø 1,5÷10 mm
- 6 offset hexagon key wrenches Ø 2-2,5-3-4-5-6 mm
- 8 T - handle wrenches with swivelling socket  
Ø 7-8-10-12-13-14-17-19 mm
- 19 1/2" square drive hexagon sockets Ø 10-11-12-13-14-15-16-17-18-19-20-21-22-23-24-26-27-30-32 mm
- 1 1/2" drive extension bar 125 mm
- 1 1/2" drive extension bar 255 mm
- 1 1/2" drive universal joint
- 1 1/2" drive sliding T-handle 305 mm
- 1 1/2" drive reversible ratchet

Beta N.	TR
42	T15
	+T16
55	T33
96/SC9	T33
96T	T52
952	T63
920A	T83
920/21	T83
920/22	T83
920/25	T83
920/42	T83
920/55	T83

**N. Quantity/Description**

- 1 heavy duty diagonal cutting nippers ✂ 160 mm
- 1 half-round needle nose pliers = 180 mm
- 1 extra long needle knurled nose pliers, bi-material handles  
● 160 mm
- 1 circlip pliers straight, internal ⊖ 180 mm
- 1 circlip pliers bent, internal ⊖ 170 mm
- 1 circlip pliers straight, external ● 175 mm
- 1 circlip pliers bent, externa ● 175 mm
- 1 self - locking pliers 240 mm
- 1 slip joint pliers boxed jointsa 250 mm
- 7 screwdrivers for cross head Phillips® screws ● 2,5x50 -3x75 - 3,5x100 - 4x125 -5,5x100 - 5,5x150 - 6,5x150 mm
- 6 screwdrivers for cross head Phillips® screws ⊕ PH0x60 - PH0x100 - PH1x80 - PH1x120 - PH2x100 - PH2x150 mm
- 2 flat chisels, ribbed type 100-200 mm
- 1 engineer's hammer 300 g
- 1 soft face hammer Ø 35 mm
- 1 empty thermoformed tray

Beta N.	TR
1084BM	T131
1150BM	T131
1166BM	T131
1032	T145
1034	T145
1036	T145
1038	T145
1052	T153
1048	T153
1260	T199
1262	T202
35	T234
1370	T234
1390	T234
VP5	

059040415 17 kg  
€ 1.034,00 € 890,70



M10

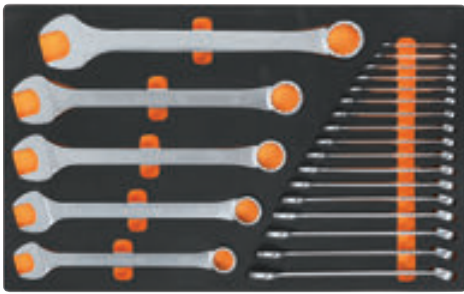

42 6-7-8-9-10-11-12-13-14-15-16-17-18-19-20-21-22-24-27-30-32-36 mm

024500010 4,5 kg  
€ 279,00 € 232,00

M30



55 6x7-8x9-10x11-12x13-14x15-16x17-18x19-20x22-21x23-24x27-30x32 mm  
90 6x7-8x9-10x11-12x13-14x15-16x17-18x19-20x22-21x23-24x27-30x32 mm  
96BPC/SC9 1,5-2-2,5-3-4-5-6-8-10 mm

024500030 4,2 kg  
€ 233,50 € 191,70

M60



○ 96T 2-2,5-3-4-5-6-7-8-10 mm  
○ 97BTX/SC8 T9-T10-T15-T20-T25-T27-T30-T40  
○ 944BX 5-6-7-8-10-13 mm

024500060 1,9 kg  
€ 225,50 € 183,10

M63



○ 952 7-8-10-12-13-14-17-19 mm

024500063 3,4 kg  
€ 235,50 € 188,70

M100

12" 14"



895/1 - 895/3 - 895/6  
○ 900 4-4,5-5-5,5-6-7-8-9-10-11-12-13-14 mm  
○ 900L 5-6-7-8-9-10-11-12-13 mm  
○ 900ME 3-4-5-6-7 mm  
● 900LP 0,8x4-1x5,5-1,2x6,5-1,2x8 mm  
⊕ 900PH PH1-PH2-PH3-PH4  
⊕ 900TX T10-T15-T20-T25-T27-T30-T40  
900/20 50 mm - 900/20L 100 mm  
900/21 150 mm  
900/25 - 900BG/30 - 900/42  
⊕ 900/55  
○ 920A 8-10-11-12-13-14-15-16-17-18-19-20-21-22-23-24-26-27-28-30-32 mm  
920/15 - 920/25  
920AN/125 125 mm  
920AN/250 250 mm  
920/42  
⊕ 920/55  
⊕ 920FTX 10-12-14-16-18-20-22-24 mm  
○ 920AL 10-12-13-14-15-16-17-18-19-21-22 mm

024500100 6,7 kg  
€ 655,00 € 512,50

M105

12" 14" 38"

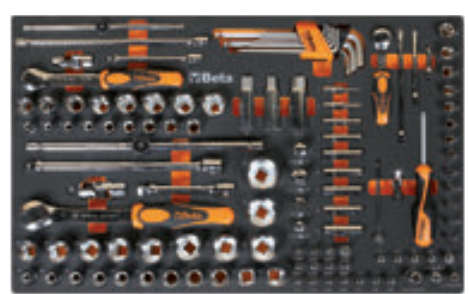

○ 900 4-4,5-5-5,5-6-7-8-9-10-11-12-13-14 mm  
○ 900L 5-6-7-8-9-10-11-12-13 mm  
○ 96BPC/SC9 1,5-2-2,5-3-4-5-6-8-10 mm  
895/1 - 895/3 - 895/6  
○ 900ME 3-4-5-6-7 mm  
● 900LP 0,8x4-1x5,5-1,2x6,5-2x8 mm  
⊕ 900PH PH1-PH2-PH3-PH4  
⊕ 900TX T10-T15-T20-T25-T27-T30-T40  
900/16 □ 1/4 - ■ 3/8  
900... 50-100-150 mm  
900/25 - 900BG/30 - 900/42  
⊕ 900/55  
○ 910A 6-7-8-9-10-11-12-13-14-15-16-17-18-19-20-21-22 mm  
910/15 □ 3/8 - ■ 1/4  
910/16 □ 3/8 - ■ 1/2  
910/21 125 mm  
910/22 250 mm  
910/25 - 910/42  
⊕ 910/55  
○ 920A 8-10-11-12-13-14-15-16-17-18-19-20-21-22-23-24-26-27-28-30-32 mm  
□ 1/2 - ■ 3/8  
920/15  
920/25  
920AN 125 - 250 mm  
920/42  
⊕ 920/55  
○ 956E 16-17,8-20,8 mm

024500871 7,7 kg  
€ 719,00 € 569,50



## M120

12<sup>''</sup>



- 920A 10-11-12-13-14-15-16-17-18-19-20-21-22-24-26-27-30-32 mm
- 920AN/125 125 mm
- 920AN/250 250 mm
- 920/25 - 920/42
- 920AL 10-12-13-14-15-16-17-18-19-22-24-27-30-32 mm
- ⊗ 920FTX 10-12-14-16-18-20-22-24 mm
- ⊗ 920/55
- 920PE 5-5L-6-6L-7-7L-8-8L-10-10L-12-12L-14-14L
- 920TX T20-T25-T27-T30-T40-T45-T50-T55-T60-T20L-T25L-T27L-T30L-T40L-T45L-T50L

024500120 6,9 kg

€ 711,00 € 541,00

## M128

12<sup>''</sup>

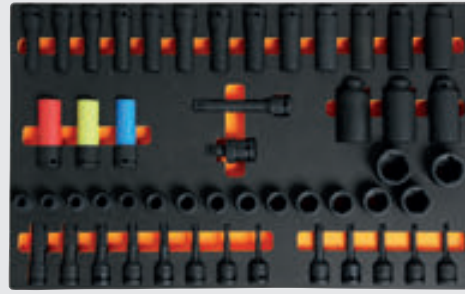

- 720 10-11-12-13-14-15-16-17-18-19-21-22-24-27-30-32 mm
- 720L 11-12-13-14-15-16-17-18-19-21-22-24-27-30-32 mm
- ⊗ 720TX T30-T40-T45-T50-T55
- 720ME 5-6-8-10-12-14-17-19 mm
- 720LC 17-19-21 mm
- 720/21 125 mm
- 720/25

024500128 8,9 kg

€ 530,00 € 403,80

**New item**

## M130



- 1032 180 mm
- 1034 170 mm
- 1036 175 mm
- 1038 175 mm
- 1048 250 mm
- 1052 240 mm
- ⚡ 1082BM 160 mm
- 1098 220 mm
- 1112 250 mm
- 1128BM
- 1150BM 180 mm
- 1166BM 160 mm
- 1168BM 160 mm

024500130 3,4 kg

€ 239,00 € 201,10

## M195

**New item**

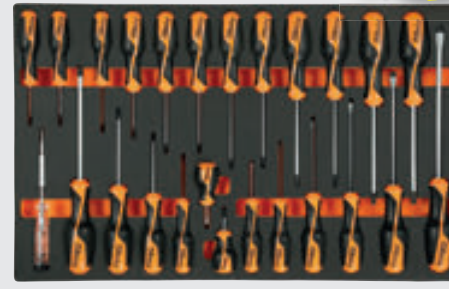

- 1260 2,5x50-3x75-4x100-5,5x125-6,5x150-8x200 mm
- 1260N 4x30 mm
- ⊕ 1262 PH0x60-PH1x80-PH2x100-PH3x150 mm
- ⊕ 1262 PH1X30 mm
- 1267TX T6-T7-T8-T9-T10-T15-T20-T25-T27-T30-T40-T45
- 1253 3,5x100 mm

024500195 2,3 kg

€ 164,50 € 133,60

## M210

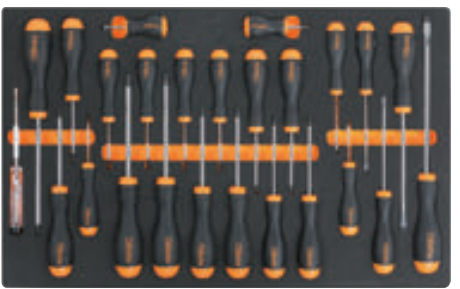

- 1201 2,5x50-3x75-4x100-5,5x125-6,5x150-8x200 mm
- 1201N 4x30 mm
- ⊕ 1202 PH0x60-PH1x80-PH2x100-PH3x150 mm
- ⊕ 1202N PH1X30 mm
- 1207TX T6-T7-T8-T9-T10-T15-T20-T25-T27-T30-T40-T45
- 1253

024500210 1,8 kg

€ 102,50 € 86,50

## M230

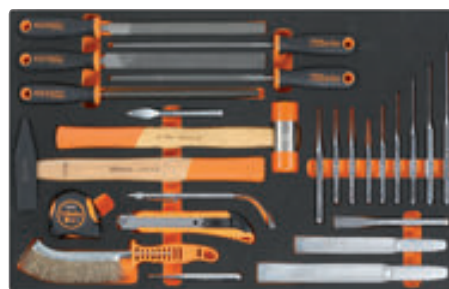

- 30 Ø 2-3-4 mm
- 31 Ø 2-3-4-5-6-8 mm
- 32 Ø 4 mm
- 34 150 mm
- 35 200-250 mm
- 36 125 mm
- 1370 500 g
- 1390 Ø 35 mm
- 1692 3 m
- 1712
- 1719BMA/Q 200 mm
- ▲ 1719BMA/T 200 mm
- 1719BMA/P 200 mm
- ▶ 1719BMA/M 200 mm
- 1719BMA/R 200 mm
- 1737
- 1771 18 mm

024500230 3,2 kg

€ 258,00 € 206,90



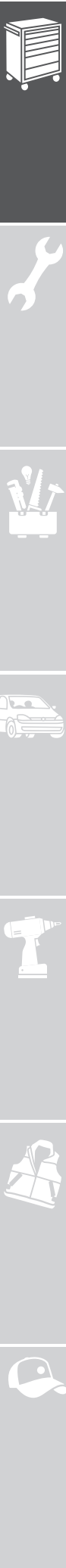

### T10



42 6-7-8-10-11-12-13-14-16  
17-18-19-21-22-24-27-30 mm

024240010 2,7 kg

€ 172,00 € 142,90

### T13 *New item*



42SLIM 8-10-11-12-13-14  
15-16-17-18-19 mm

024240013 1,5 kg

€ 97,50 € 78,10

### T15



42 6-7-8-9-10-11-12-13-14  
15-16-17-18-19-20-21 mm

024240015 1,5 kg

€ 132,00 € 109,70

### T16



42 22-24-27-30-32

024240016 2,1 kg

€ 89,50 € 77,40

### T31



31 Ø 2-3-4-5-6 mm  
32 Ø 4 mm  
55 6x7-8x9-10x11-12x13-14x15  
16x17-18x19-20x22-21x23  
24x26-27x29-30x32 mm  
○ 96N/SC9 1,5÷10 mm

024240031 3 kg

€ 140,50 € 112,50

### T40



90 6x7-8x9-10x11-12x13  
14x15-16x17-18x19 mm

024240040 810 g

€ 51,50 € 42,80

### T45



142 8-9-10-11-12-13-14  
15-16-17-18-19 mm

024240045 1,3 kg

€ 178,00 € 146,30

### T50

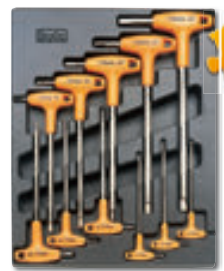

○ 96T 2-2,5-3-3,5-4-4,5  
5-6-7-8-10 mm

024240050 1,3 kg

€ 94,50 € 79,40

### T55



○ 97TTX T10-T15-T20 T25-T27-T30

024240055 330 g

€ 53,50 € 42,90

### T63



○ 952 7-8-10-12-13-14  
17-19 mm

024240063 3,8 kg

€ 230,00 € 182,20

### T83



○ 920A 10-11-12  
13-14-15-16-17-18  
19-20-21-22-23-24  
26-27-30-32 mm  
920/21 125 mm  
920/22 255 mm  
920/25  
920/42 305 mm  
920/55 @ 275 mm

024240083 3,6 kg

€ 175,00 € 145,60

### T85



- 861LP 0,5x3-0,6x4,5-0,8x5,5-1x5,5  
1,2x6,5-1,2x8-1,6x8 mm
- 861PE 2-2,5-3-4-5-6-8-10 mm
- 861PH PH0 - PH1 - PH2 - PH3
- 861PZ PZ1 - PZ2 - PZ3
- 861TX T6-T7-T8-T9-T10-T15-T20-T25-T27-T30-T40
- 861RTX T9-T10-T15-T20-T25-T27-T30-T40
- 861TRW 1-2-3-4-5-6 mm
- 861TQS 0-1-2-3-4-5-6-8 mm
- 861SP 4-6-8-10-12 mm
- 851SR 230 mm
- 900 4-4,5-5-5,5-6-7-8-9-10-11-12-13-14 mm

900/21 150 mm 900/25 41 mm  
900BG/30 176 mm 900/42 115 mm  
● 900/55 125 mm 194 1/4x5/16

024240085 1 kg

€ 173,50 € 140,80

### T91



- 900 4-4,5-5-5,5-6  
7-8-9-10-11-12  
13-14 mm
- 900ME 2,5-3-4-5  
6-8 mm
- 900/20 50 mm
- 900/21 150 mm
- 900/25
- 900BG/30 176 mm
- 900/42 115 mm
- 900/55 125 mm

024240091 560 g

€ 121,00 € 98,10

### T92



- 910A 6-7-8-9-10-11  
12-13-14-15-16-17-18  
19-20-21-22 mm
- 910/21 125 mm
- 910/22 250 mm
- 910/25
- 910/42 210 mm
- 910/55 200 mm

024240092 1,5 kg

€ 149,50 € 121,20



### T103

12 14



- 900L 6-7-8-9-10-11-12 mm
- 920AL 13-14-16-17-18-19  
21-22-24-27 mm

024240103 1,1 kg

€151,50 € 121,50

### T131



- 1084BM 160 mm
- 1150BM 180 mm
- 1166BM 160 mm

024240131 750 g

€65,00 € 55,80

### T145



- 1032 180 mm
- 1034 170 mm
- 1036 175 mm
- 1038 175 mm

024240145 640 g

€66,00 € 57,10

### T153



- 1048 250 mm
- 1052 240 mm

024240153 1,1 kg

€37,50 € 32,10

### T199



Beta GRIP

- 1260 2,5x50 - 3x75 - 3,5x100  
4x125 - 5,5x100 - 5,5x150-6,5x150 mm

024240199 490 g

€34,50 € 28,40

### T202



Beta GRIP

- 1262 PH0x60 - PH0x100 - PH1x80  
PH1x120 - PH2x100 - PH2x150 mm

024240202 490 g

€32,50 € 26,50

### T205



Beta GRIP

- 1267TX T6-T7-T8-T9-T10-T15-T20

024240205 460 g

€33,50 € 27,50

### T210



Beta ERSY

- 1201 2,5x50-3x75-3,5x100-4x125  
5,5x100-5,5x150 6,5x150 mm

024240210 490 g

€23,10 € 18,70

### T212



Beta ERSY

- 1202 PH0x60-PH1x80-PH1x120  
PH2x100-PH2x150-PH3x150 mm

024240212 490 g

€24,30 € 19,70

### T215



Beta ERSY

- 1207TX T6-T7-T8-T9-T10-T15-T20

024240215 410 g

€24,10 € 19,50

### T234



- 35 100-200 mm
- 1370 300 g
- 1390 ø 35 mm

024240234 1,3 kg

€62,50 € 51,60

### T236



- 1719BMA/Q 200 mm
- ▲ 1719BMA/T 200 mm
- 1719BMA/P 200 mm
- ▷ 1719BMA/M 200 mm
- 1719BMA/R 200 mm

024240236 870 g

€58,50 € 47,60

### T239



- 31BM Ø 2-3-4-5-6-8 mm
- 32 ø 4 mm

024240239 850 g

€87,50 € 72,70





## C45

### COMBINATION COMPRISING:

- Fixed module with 7 drawers 566x406 mm
- Fixed service module
- Mobile roller cab with 7 drawers 532x406 mm
- Two-door tool cabinet
- 3 perforated tool panels
- 3 wall-mounted cabinets
- 3 wall brackets, wide type
- 1 wall bracket, narrow type

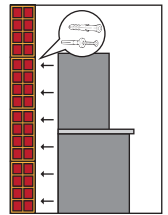

## C45/X

Workshop equipment combination C45/X  
 • Worktop made of MDF stainless steel coated (C45PX/3-2,0MT)

045000010 294 kg  
 € 2.600,00 € 2.006,00



## C45/W

Workshop equipment combination C45/W  
 • Multi-ply wood worktop (C45PW/3-2.0MT)

045000020 260 kg  
 € 2.520,00 € 1.948,00

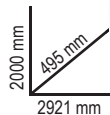

## C45/B

### COMBINATION COMPRISING:

- Fixed module with 5 drawers 566x406 mm
- Fixed two-door module
- Single-door tool cabinet
- 2 wall-mounted cabinets
- 2 perforated tool panels
- 2 wall brackets, wide type
- 1 wall bracket, narrow type

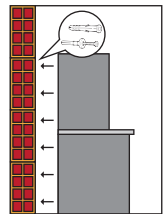

## C45/BX

Workshop equipment combination C45/BX  
 • Worktop made of MDF stainless steel coated (C45PX/2-1.3MT)

045000043 275 kg  
 € 1.600,00 € 1.234,50



## C45/BW

Workshop equipment combination C45/BW  
 • Multi-ply wood worktop (C45PW/2-1.,3MT)

045000053 260 kg  
 € 1.530,00 € 1.183,00

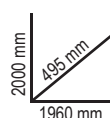



# 5945VUM

Assortment of 231 tools for universal use



Recommended for use in combination with mobile roller cab: C45



MM10

30

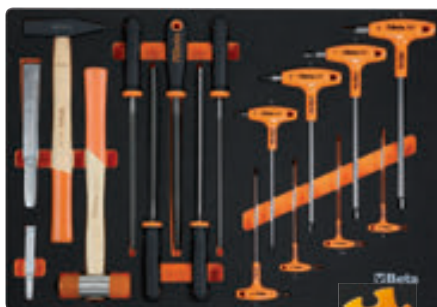

MM61

17



MM105

107



MM140

52



MM210

25

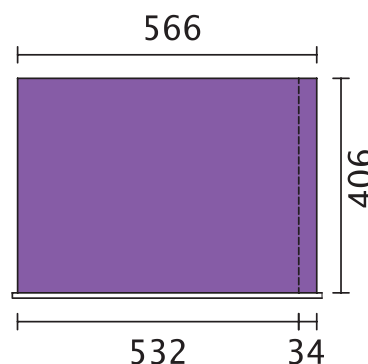

**Quantity/Description**

Quantity/Description	Beta N.	TR
21 combination wrenches 6-7-8-9-10-11-12-13-14-15-16-17-18-19-20-21-22-24-27-30-32 mm	42	MM10
9 offset hexagon key wrenches $\odot$ 2-2,5-3-4-5-6-7-8 mm	96BPC/SC9	MM10
8 engineer's hammer 300 g	96T	MM61
1 soft face hammer $\varnothing$ 35	1370	MM61
1 flat chisels, ribbed type 100-200 mm	1390	MM61
2 second cut files 200 mm	35	MM61
5 ball head offset hexagon key wrenches $\odot$ 1,5-2-2,5-3-4-5-6-8-10 mm	1719BMA8/S5	MM61
1 socket holder $\odot$ 1/4 - $\square$ 1/4	895/1	MM105
1 socket holder $\odot$ 1/4 - $\square$ 3/8	895/3	MM105
1 socket holder $\odot$ 5/16 - $\square$ 1/2	895/6	MM105
13 1/4" hexagon sockets $\odot$ 4-4,5-5-5,5-6-7-8-9-10-11-12-13-14 mm	900	MM105
9 hexagon hand sockets, long series $\odot$ 5-6-7-8-9-10-11-12-13 mm	900L	MM105
5 1/4" socket drivers for hexagon screws $\odot$ 3-4-5-6-7 mm	900ME	MM105
4 socket drivers for slotted head screws $\bullet$ 0,8x4-1x5,5x1,2x6,5-1,2x8 mm	900LP	MM105
4 socket drivers for cross head Phillips® screws $\oplus$ PH1-PH2-PH3-PH4	900PH	MM105
7 socket drivers for Torx® head screws $\odot$ T10-T15-T20-T25-T27-T30-T40	900TX	MM105
1 adaptor, 1/4" female and 3/8" male drives $\square$ 1/4 - $\blacksquare$ 3/8	900/16	MM105
1 1/4" drive extension bar 50 mm	900/20	MM105
1 1/4" drive extension bar 100 mm	900/20L	MM105
1 1/4" drive extension bar 150 mm	900/21	MM105
1 1/4" drive universal joint	900/25	MM105
1 1/4" drive spinner handle 176 mm	900BG/30	MM105
1 1/4" drive swivel T-handle 115 mm	900/42	MM105
1 1/4" reversible ratchet $\odot$ 125 mm	900/55	MM105
17 hexagon hand sockets 3/8" $\odot$ 6-7-8-9-10-11-12-13-14-15-16-17-18-19-20-21-22 mm	910A	MM105
1 adaptor, 3/8" female and 1/2" male drives $\square$ 3/8 - $\blacksquare$ 1/2	910/15	MM105
1 adaptor, 1/2" female and 3/8" male drives $\square$ 3/8 - $\blacksquare$ 1/2	910/16	MM105
1 extension bar - 3/8" 125 mm	910/21	MM105
1 extension bar - 3/8" 250	910/22	MM105
1 3/8" drive universal joint	910/25	MM105
1 3/8" drive sliding T - handle 210 mm	910/42	MM105
1 3/8" drive reversible ratchet $\odot$ 200 mm	910/55	MM105
21 1/2" square drive hexagon sockets $\odot$ 8-10-11-12-13-14-15-16-17-18-19-20-21-22-23-24-26-27-28-30-32 mm	920A	MM105
1 adaptor, 1/2" female and 3/8" male drives $\square$ 1/2 - $\blacksquare$ 3/8	920/15	MM105
1 1/2" drive universal joint	920/25	MM105
1 1/2" wobble extension bar 125 mm	920AN	MM105
1 1/2" wobble extension bar 250 mm	920AN	MM105
1 1/2" drive sliding T-handle 305 mm	920/42	MM105

**Quantity/Description**

Quantity/Description	Beta N.	TR
1 1/2" drive reversible ratchet $\odot$ 275 mm	920/55	MM105
3 3/8" square drive spark plug sockets $\odot$ 16 mm (5/8")-17,8 (11/16")-20,8 (13/16")	956E	MM105
5 drivers for Torx® head screws, with handles $\odot$ T10-T15-T20-T25-T30	97TTX	MM140
1 heavy duty diagonal cutting nippers $\leq$ 160 mm	1084BM	MM140
1 half-round needle nose pliers $\equiv$ 180 mm	1150BM	MM140
1 extra long needle knurled nose pliers, bi-material handles $\bullet$ 160 mm	1166BM	MM140
1 circlip pliers straight, internal $\odot$ 19=60 mm	1032	MM140
1 circlip pliers bent, internal $\odot$ 19=60 mm	1034	MM140
1 circlip pliers straight, external $\bullet$ 19=60 mm	1036	MM140
1 circlip pliers bent, external $\bullet$ 19=60 mm	1038	MM140
1 slip joint pliers boxed joints 250 mm	1048	MM140
1 self - locking pliers 240 mm	1052	MM140
38 microscrewdriver with 36 interchangeable 4-mm bits and magnetic extension	1256/C36-2	MM140
6 screwdrivers for cross head Phillips® screws $\bullet$ 04x2,5x50-0,5x3x75-0,8x4x100-1,0x5,5x125-1,2x6,5x150-1,2x8x200 mm	1201	MM210
1 screwdrivers for slotted head screws, extra-short series $\bullet$ 0,8x4x30 mm	1201N	MM210
4 screwdrivers for cross head Phillips® screws $\oplus$ PH0x60-PH1x80PH2x100PH3x150 mm	1202	MM210
1 screwdrivers for cross head Phillips® screws, extra-short series $\oplus$ PH1x30 mm	1202N	MM210
12 drivers for Torx® head screws, with handles $\odot$ T06-T07-T08-T09-T10-T15-T20-T25-T27-T30-T40-T45	1207TX	MM210
1 mains testing screwdriver $\bullet$ 0,5x3,5x100 mm	1253	MM210

059450001 19,6 kg  
~~€ 1.510,00~~ € 1.212,00





## C56B

### Workbench with wood top

Main features:

- Multi-ply wood worktop with holes for a vice (1599F/125, to be ordered separately)
- Steel frame with 4 supporting legs
- Lower object shelf
- Can be fixed to floor

Kg  
600



930 mm

720 mm

2000 mm

62 kg



C56B

056000401

056000402

056000403

€ 442,00

€ 336,20

## C58B

### Workbench

- Worktop made of painted sheet metal with external edge
- Steel frame with 6 supporting legs
- Two drawers with lock
- Can be fixed to floor

Kg  
800



930 mm

720 mm

1500 mm

59 kg



C58B

058000401

058000402

058000403

€ 406,00

€ 309,50

## C59A

### Workbench with 1 cab with six drawers

Main features:

- Worktop made from multi-ply wood with holes for vice item 1599F/125 (to be ordered separately)
- 6 drawers (588x367 mm) with ball bearing slides
- Drawers protected by foamed rubber mats
- Hard-wearing nylon drawer front
- Roller cabs can accommodate thermoformed trays
- Front centralized safety lock
- Lower object shelf
- Can be fitted with paper roll holder (2400S-R/PC) and bottle holder (2400S/PF), to be ordered separately

Kg  
1500

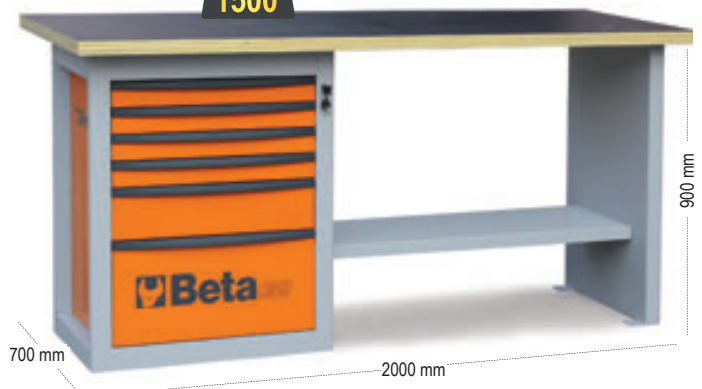

900 mm

700 mm

2000 mm

n°	h	max
4	70 mm	25 kg
1	140 mm	30 kg
1	280 mm	35 kg

115 kg



C59A

059000001

059000021

059000041

€ 1.045,00

€ 837,50





## C56

### Workbench with wood top

Main features:

- Multi-ply wood worktop with holes for a vice (1599F/125, to be ordered separately)
- Steel frame with 4 supporting legs
- Lower object shelf
- Can be fixed to floor

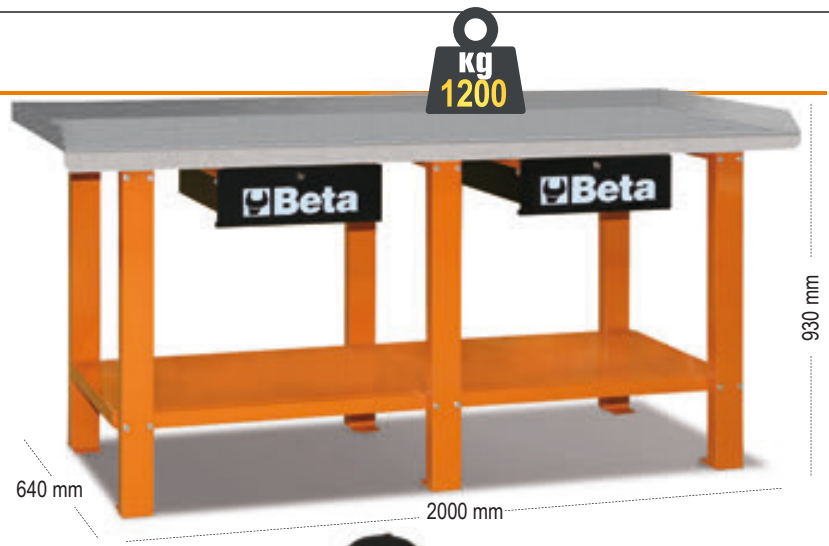

82 kg



C56

056000201

056000202

056000203

~~€ 608,00~~

€ 487,50



## C56PO

### Folding workbench

- 30-mm-thick worktop made of MDF and galvanized sheet iron; can be used on both sides
- Handle with rubber protection for easy transport
- Feet with anti-slip coating

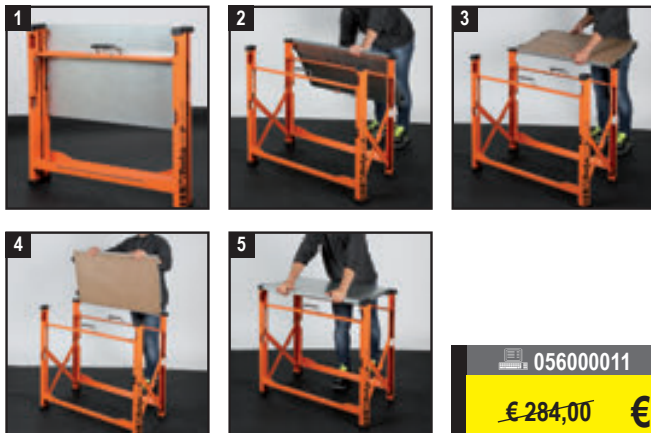

056000011 25 kg

~~€ 284,00~~

€ 222,20

## C51

### Trolley

- 3 tops covered in antislip ribbed rubber
- Two fixing options for central worktop
- Four castors Ø 100 mm: 2 fixed and 2 steering (1 with brake)



21 kg



C51

051000001

051000002

051000003

~~€ 189,50~~

€ 148,20





## C27S

### Folding tool trolley for outdoor jobs, empty

- Folding tool trolley. Its unique patented design guarantees an effortless transport
- 2 drawers, 588x277 mm, with ball bearing slides, for two-way opening
- Large lower object compartment, 588x277x220 mm
- Sheet metal frame
- 2 fixed castors, Ø 160 mm, and 2 steering castors with brake, Ø 100 mm
- Thermoplastic worktop with 6 built-in tool trays
- Centralized lock
- Can accommodate drawer partitions and MC foam tool trays



n°	h	m <sub>max</sub>
2	70 mm	20 kg



20 kg

C27S	027000201	027000202	027000203	€ 453,00	€ 367,40
------	-----------	-----------	-----------	----------	----------

## 5927VU/M



### Assortment of 108 tools in soft foam tray for C27S trolley

for drawer: 588x277 mm

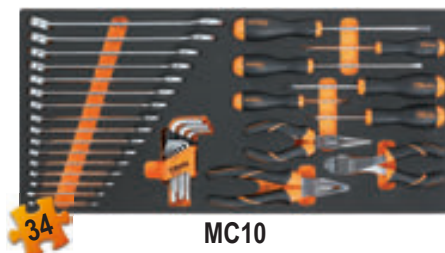

MC10



MC20

059270021	8,3 kg
€ 563,00	€ 457,00

## C41H

### Two-module tool trolley

Main features:

- Sheet metal frame and plastic tops, synonymous with remarkable sturdiness and reduced weight
- 2 detachable modules:
  - 1 upper tool box,
  - 1 module with 2 drawers 95 mm in height,
  - 1 pull-out case made of plastic, 66 mm high, and 1 drawer 295 mm in height
- Oversized castors (160 mm), built into frame for easy transport - for example, on steps
- Side centralized lock for closing drawers of lower module
- Drawers with ball bearing slides and double closing hook
- Telescopic aluminium handle
- Small tool holder built into upper tool box
- Lower drawer with double ballbearing slide



C41H W RAL 9016

C41H Y RAL 1023

C41H R RAL 3000

C41H V RAL 6016

C41H B RAL 5002

C41H G RAL 7016

C41H N RAL 9005

21 kg

C41H	041000002	041000021	041000012	041000008	€ 408,00
	041000024	041000006	041000010	041000005	€ 318,90





**Tool box, made from plastic, removable tote-tray and tool trays, empty**

- 2 removable tool trays built into cover with adjustable partitions
- 1 interior tote-tray with adjustable partitions
- Carrying capacity: 30 kg

**CP15L**



558x277x270 mm



021150202 2,5 kg  
~~€ 42,00~~ € 33,40

**CP15**



445x240x250 mm

021150201 2 kg  
~~€ 31,50~~ € 25,00

**C14**

**Tool trolley, made of polypropylene, with 4 drawers, empty**

- Injection polypropylene frame for increased shock resistance
- 4 sturdy rear castors
- 3 tote-trays included
- Nameplate
- Can be closed with TSA lock

Removable top tray



580x380x455 mm

- Lid-protected front accommodates 4 pull-out drawers (470x255):  
 1 drawer 30 mm high  
 2 drawers 60 mm high  
 1 drawer 90 mm high



Front centralised lock allows top and front lids to be closed simultaneously



Two side handles

021140000 10 kg  
~~€ 607,00~~ € 474,80

**5914VU/M**

**Assortment of 109 tools for trolley C14, in soft foam tray**



MC T1



MC T2

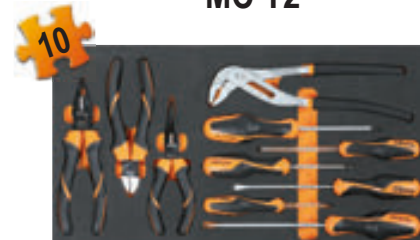

MC T3

\* When used in combination with tool trolley C14, remove upper tool panel.

\* assortment only

059140111 8,5 kg  
~~€ 619,00~~ € 502,00





## C20L

Five-section cantilever tool box, made from sheet metal, empty



550x200x210 mm

021200002 5,4 kg

€ 51,50 € 40,20

## C16

Tool box, made of plastic, with interior object compartment, empty



500x260x260 mm

021160000 2,5 kg

€ 76,50 € 61,40

## C20TSS

Five-section cantilever tool box, made of AISI 304 stainless steel can be used in critical environments - that is, in areas where the minimum contamination level is not permitted -, is resistant to rust and the main acids, and can be autoclave sterilized at 121 °C.



450x200x210 mm

021203001 4 kg

€ 167,50 € 131,20

## 2080/V6

Organizer tool case with 6 removable tote-trays and adjustable partitions

Removable, folding clear tote-trays, for immediate recognition of contents



4385x320x60 mm

020800060 1,2 kg

€ 25,00 € 19,80

## CP17

Tool box, made of stainless steel and plastic, removable tote-tray, empty



500x200x220 mm

021170500 2,5 kg

€ 60,50 € 47,10



## 2080/V12

Organizer tool case with 12 removable tote-trays

Removable, folding clear tote-trays, for immediate recognition of contents



300x330x145 mm

020800000 1,8 kg

€ 37,50 € 29,80



## Technical fabric tool bags

Lightweight and sturdy, for absolutely safe transportation of your tools



### C5

- Rucksack, empty**
- Removable interior tool panel
  - Six exterior pockets and two interior pockets
  - Waterproof plastic base
  - Double safety lace for fixing rucksack to shoulders
  - Ergonomic padded back



021050000 2,5 kg  
~~€ 101,50~~ € 79,50

500x400x180 mm

### C6T

- Rucksack with castors, empty**
- Telescopic handle for easy transport
  - Built-in castors with practical dustproof cover for use as a rucksack
  - Two removable tool panels
  - Interior PC pocket and five exterior pockets
  - Waterproof plastic base



021060010 4,5 kg  
~~€ 149,00~~ € 116,60

480x370x220 mm

### C7

- Bag, empty**
- 2 removable interior tool panels
  - 2 exterior front pockets
  - Interior bottom made of plastic, with removable partitions



021070000 3,5 kg  
~~€ 152,00~~ € 118,60

440x370x170 mm

### C11

- Box, empty**
- Hard water resistant plastic base
  - Elastic tool bands and interior and exterior tool pockets
  - Document holders built into double bottom of cover



021110000 2 kg  
~~€ 61,50~~ € 48,10

400x240x220 mm

### C8

- Trolley, empty**
- Telescopic carrying handle
  - 2 removable interior tool panels
  - Interior PC pocket and 2 exterior front pockets
  - Can accommodate tool box item C10S



021080000 4 kg  
~~€ 178,50~~ € 139,40

470x370x280 mm

- Box, empty**
- Hard frame
  - Double bottom.
  - Tilting handle for easier access to tools
  - Elastic tool bands and interior and exterior pockets
  - Cover
  - Tool tray included in double bottom
  - Can be used with trolley C8



### C10S

420x220x250 mm

021100001 2,3 kg  
~~€ 81,00~~ € 63,40

### C10

520x220x250 mm

021100000 3,3 kg  
~~€ 103,50~~ € 81,00



## 2029/VV

Tool case, made of thick polypropylene, aluminium edged, empty  
 • 2 interior tool panels

490x380x230 mm

020290000 6,1 kg

€ 248,50 € 170,80



## 2038/TV

Tool trolley, made of thick polypropylene, empty  
 • Highly shock resistant  
 • Aluminium sealing profile  
 • Telescopic handle and big ball bearing castors  
 • Capacious bottom  
 • Document pocket  
 • 3 tote drawers

430x500x340 mm

2 removable tool panels



2 ergonomic rubber-coated handles (including 1 side handle)



2 TSA approved locks with keys



## 2028/VV

Tool trolley, made of thick polypropylene, empty  
 • 2 tool panels  
 • Interior bottom with removable partitions  
 • Double combination lock



020280010 4,5 kg

€ 162,50 € 127,00

470x185x410 mm





## 42/SP15P

**New item**

Set of 15 combination wrenches with holder



**NEW DESIGN**



6-7-8-9-10-11-12-13  
14-15-16-17-19-22-24 mm

000421078 2,1 kg

€121,00 € 98,20

## 42/SC9IP

Set of 9 combination wrenches

- compact, practical, easy-to-carry support
- quickly identified wrench size
- wrench safely locked in support

**NEW DESIGN**



8-10-11-12-13-14-15-17-19 mm



000421087 890 g

€69,50 € 56,30

**New item**

## 42INOX/SC9

Set of 9 combination wrenches made of stainless steel with compact support

8-10-11-12-13-14-15-17-19 mm



000420387 812 g

€135,50 € 108,70



## NEW DESIGN

Our epoch-making wrench 42 has a new shape. A stylish, slim shape enhanced by a slender profile, lighter to the touch, head thickness having been reduced to a minimum, to allow you to gain proper access to all spaces. The **strength, resilience and rapidity** of use of the Beta wrench reach even higher values, to provide users with the best possible tool. The **manufacturing process** is carried out in our factories in Sovico and Sulmona, on the basis of state-of-the-art automation technology and the best trained workers.

### Rapid

A 15 degree angle compared to the axis, to reduce the take-up angle

### Resilient

Remarkable strength: in case of improper use, the wrench buckles, without breaking suddenly and dangerously

### Homogeneous

Pressing is based on a round-section semi-finished product which results in homogeneously distributed fibres, thereby preventing dangerous internal stress formation

### Accessible

Reduced thickness for improved accessibility

### Protected

Nickel-chrome plating provides lasting resistance to external agents and meets the stringent requirements of adhesion tests under ISO 2819

### Powerful

Torque values more than doubled compared to the requirements to be satisfied under ISO 1711

### Optimized

The wrench, which is longer than most competitors', allows high torques to be obtained through reduced effort

### Ergonomic

The offset ring has a 15 degree angle to protect the hand. The shape is obtained from a die; it is not bent later.



MADE IN ITALY

## 141/B9

**New item**

Set of 9 ratcheting combination wrenches, straight series, in cloth wallet

8-10-11-12-13-14-15-17-19 mm



001410069 900 g  
~~€ 119,50~~ € 94,60

## 42SLIM/B8I

**New item**

Set of combination wrenches with thin open ends, in wallet  
 Thinner head

10-11-12-13  
 14-15-17-19 mm



000420468 700 g  
~~€ 70,50~~ € 56,40

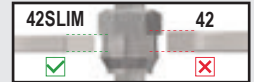

## 142/SC9I

Set of 9 reversible ratcheting combination wrenches, with compact support

8-10-11-12-13-14-15-17-19 mm



001420087 1,2 kg  
~~€ 126,50~~ € 103,90

## 142SN/SC9

Set of 9 swivel end ratcheting combination wrenches with compact support

8-10-11-12-13-14-15-17-19 mm



001420259 1,3 kg  
~~€ 169,00~~ € 128,60

## 192/S2

Set of 2 reversible ratcheting offset bi-hex ring wrenches

**8 sizes in 2 wrenches**

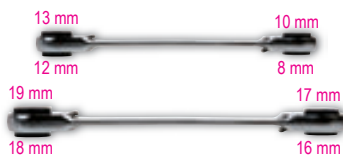

001920070 500 g  
~~€ 42,50~~ € 33,30

## 55/SP7

Set of 7 double open end wrenches with holder

6x7-8x9-10x11-12x13  
 14x15-16x17-18x19 mm



000550167 920 g  
~~€ 34,50~~ € 26,50





# 111

## Adjustable wrenches with scales, chrome-plated

- Movable jaw opening with right-hand rotation of pin
- Head angled at 22.5 degrees, with mm and inch scale



	L mm	A max	g			
111/100	100	15 mm	60	001110010	<del>€ 12,00</del>	€ 9,80
111/150	150	24 mm	165	001110015	<del>€ 12,10</del>	€ 9,90
111/200	200	28 mm	325	001110020	<del>€ 15,30</del>	€ 12,40
111/250	250	34 mm	505	001110025	<del>€ 19,10</del>	€ 15,50
111/300	300	35 mm	790	001110030	<del>€ 25,00</del>	€ 20,40
111/450	450	54 mm	2043	001110045	<del>€ 94,50</del>	€ 73,70
111/600	600	62 mm	3300	001110060	<del>€ 130,50</del>	€ 102,10

*mm/inch readout*

# 90/S7

## Set of 7 double ended deep offset ring wrenches

- 6x7-8x9-10x11-12x13-14x15  
16x17-18x19 mm



000900163 800 g  
~~€ 47,50~~ € 38,50

# 96T/S5P

## Set of 5 offset hexagon key wrenches with handles

- Ø 2,5-3-4-5-6 mm



000960946 300 g  
~~€ 33,50~~ € 27,10

# 97TTX/S6

## Set of 6 ball head offset key wrenches for Torx® head screws with handles

- Ø T10-T15-T20-T25-T30-T40



000970791 400 g  
~~€ 51,00~~ € 40,00

# 951/S6

## Set of 6 T-handle wrenches with three hexagon male ends

- Ø 2,5-3-4-5-6-8 mm



009510687 600 g  
~~€ 77,50~~ € 64,70

# 952/D7

## Set of 7 T-handle wrenches with swivelling hexagon sockets

- Ø 7-8-10-12-13-14-17 mm

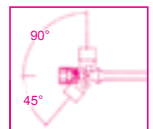

009520079 2,5 kg  
~~€ 171,00~~ € 135,60



### 96/SC9

Set of 9 offset hexagon key wrenches



Ø mm	L mm
1,5	42
2	48
2,5	59
3	62
4	70
5	81
6	92
8	102
10	116

000960374 300 g  
~~€ 11,40~~ € 9,10

### 97BTXL/SC8

Set of 8 ball head offset key wrenches, long model, for Torx® head screws



Ø mm	L mm
T9	83
T10	89
T15	103
T20	114
T25	130
T27	145
T30	166
T40	183

Extra long version +25%

000970364 240 g  
~~€ 47,00~~ € 36,20

### 96BP-CL/SC9

Set of 9 ball head offset hexagon key wrenches, coloured



Ø mm	L mm
1,5	91
2	100
2,5	113
3	130
4	142
5	163
6	185
8	205
10	231

Extra long version +30%

New item

000961619 440 g  
~~€ 21,00~~ € 16,80

### 96BPC/SC9

Set of 9 ball head offset hexagon key wrenches



Ø mm	L mm
1,5	79
2	85
2,5	89
3	100
4	110
5	129
6	152
8	173
10	194

000960354 400 g  
~~€ 20,80~~ € 16,20

### 96LBP/SC9

Set of 9 ball head offset hexagon key wrenches

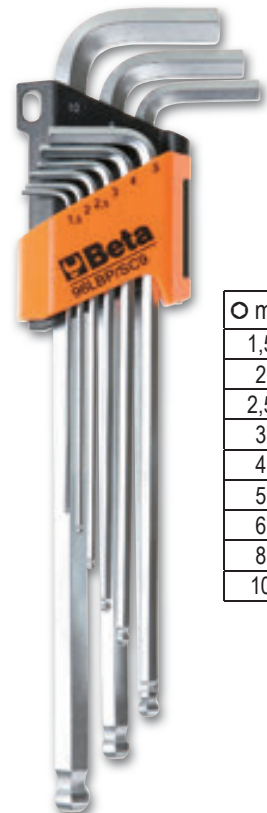

Ø mm	L mm
1,5	91
2	100
2,5	113
3	130
4	142
5	163
6	185
8	205
10	231

Extra long version +30%

000961354 500 g  
~~€ 17,90~~ € 14,00

### 97BTX/SC8

Set of 8 ball head offset key wrenches, for Torx® head screws



Ø mm	L mm
T9	65
T10	74
T15	84
T20	96
T25	98
T27	109
T30	123
T40	136

000970164 170 g  
~~€ 41,00~~ € 31,70



**1297TX/LS5** *New item*

Set of 5 Beta Max screwdrivers for Torx® head screws  
 ⦿ T15-T20-T25-T30-T45

Long version

⦿	L (mm)	L1 (mm)
T15	210	319
T20	210	319
T25	210	319
T30	210	330
T45	210	342

012970325 620 g  
~~€ 40,50~~ € 31,90

BetaMax  
 Maximum Performance

**944BX/D6**

Set of 6 deep, hi-torque hexagon nut spinners long series

⦿ 5-6-7-8-10-13 mm

009440056 1 kg  
~~€ 86,00~~ € 68,20

BetaMax  
 Maximum Performance

**1293/D8**

Set of 8 screwdrivers

1290 ⦿ 3x75-4x100-5,5x150-6,5x150 mm  
 1292 ⦿ PH0x60-PH1x80- PH2x100 mm

012930403 730 g  
~~€ 49,00~~ € 39,70

BetaMax  
 Maximum Performance

**1203/D8P**

Set of 8 screwdrivers

1201 ⦿ 2,5x50-3x75-4x100-5,5x100-6,5x150 mm  
 1202 ⦿ PH0x60-PH1x80- PH2x100 mm

012030018 640 g  
~~€ 23,40~~ € 19,00

**1203/D10N**

Set of 10 screwdrivers

1201 ⦿ 2,5x50-3x75-4x100-5,5x150-6,5x150 mm  
 1202 ⦿ PH0x60-PH1x80- PH2x100 mm  
 1201N ⦿ 4x30 mm  
 1202N ⦿ PH1x30 mm

012030019 740 g  
~~€ 30,50~~ € 24,90

**1207TX/D7**

Set of 7 screwdrivers

1207TX ⦿ T6-T8-T10-T15-T20-T25-T30

012070207 560 g  
~~€ 23,70~~ € 19,20

Beta  
 EASY

**1263/D8**

Set of 8 screwdrivers

1260 ⦿ 2,5x50-3x75-4x100- 5,5x125-6,5x150 mm  
 1262 ⦿ PH0x60-PH1x80- PH2x100 mm

012630008 600 g  
~~€ 36,00~~ € 29,20

**1263/D10**

Set of 10 screwdrivers

1260 ⦿ 3x75-3,5x100-4x125-5,5x150-6,5x150 mm  
 1262 ⦿ PH0x60- PH1x80-PH2x100 mm  
 1260N ⦿ 4x30 mm  
 1262N ⦿ PH1x30 mm

012630010 690 g  
~~€ 45,00~~ € 36,70

**1267TX/D7**

Set of 7 screwdrivers

1267TX ⦿ T6-T8-T10-T15-T20-T25-T30

012670307 500 g  
~~€ 33,00~~ € 26,80

**1293INOX/D8**

Set of 8 stainless steel screwdrivers

1290INOX ⦿ 2,5x50-3x75-4x100-5,5x125-6,5x150 mm  
 1292INOX ⦿ PH0x60-PH1x80- PH2x100 mm

012930408 551 g  
~~€ 38,50~~ € 30,70

Beta  
 INOX  
 STAINLESS STEEL

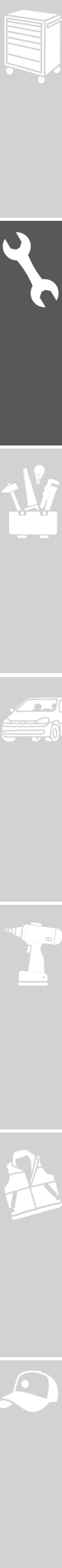

12" 14" 38"

Reversible ratchet



	L mm	Ø mm	A mm	■	g			
900/55	125	25	18	1/4"	90	009000870	<del>€ 26,50</del>	€ 22,30
910/55	200	30	33	3/8"	239	009100882	<del>€ 34,00</del>	€ 27,10
920/55	275	40	43	1/2"	475	009200882	<del>€ 40,50</del>	€ 34,00

12" 14" 38"

Reversible ratchet with rotating handle

- Ring nut reversal system on ratchet head
- Bi-material handle

Rotating the handle clockwise and anticlockwise will make the bit turn quickly

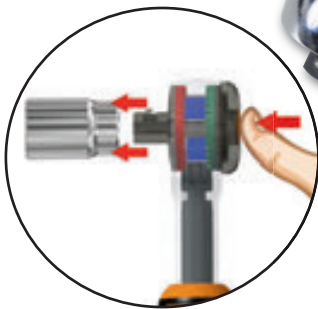

Socket release button



	L mm	Ø mm	A mm	■	g			
900/58	126	28	28,5	1/4"	155	009000884	<del>€ 41,50</del>	€ 34,90
910/58	222	37	38,5	3/8"	417	009100884	<del>€ 50,50</del>	€ 42,80
920/58	281	42,5	45	1/2"	705	009200926	<del>€ 57,50</del>	€ 48,30

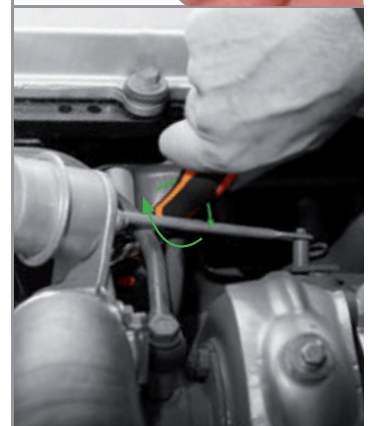

920INOX/C16

Set of 15 sockets and 1 ratchet, made of stainless steel, in plastic case



	920INOX-A	○	10-12-13-14-15 16-17-18-19-21 22-24-27-30-32 mm
	920/55INOX	⊗	



STAINLESS STEEL + NO STAINLESS STEEL = RUST



STAINLESS STEEL + STAINLESS STEEL = NO RUST

BETA INOX TOOLS CAN BE AUTOCLAVE STERILIZED AT 121°C

009203916	3,1 kg
<del>€ 839,00</del>	€ 655,50

387x174x65 mm



Assortment of 11 hexagon sockets, 21 bits and 7 accessories in plastic case



14" 1/4"

	861LP	●	0,6x4,5-1,2x6,5-1,2x8 mm
	861PE	○	2,5-3-4-5-6 mm
	861PH	⊕	PH1-PH2-PH3
	861PZ	⊕	PZ1-PZ2-PZ3
	861RTX	⊕	T10-T15-T20-T25-T27-T30-T40 mm
	892/0	●	1/4" - 1/4"
	895/1	○	1/4" - 1/4"
	900	○	5-5,5-6-7-8-9-10-11-12-13-14 mm
	900/20		50 mm
	900/20L		100 mm
	900/25		
	900BG/30C		128 mm

## 900/C39

reversible ratchet (900/55)

009000937 785 g

€ 95,50 € 77,40



## 900/C39-R

reversible ratchet with rotating handle (900/58)

009000938 840 g

€ 115,50 € 93,80



Assortment of 12 hexagon sockets, 20 bits and 7 accessories, in metal case



350x150x50 mm

14" 1/4"

	861LP	●	0,5x3-0,8x5,5-1x5,5-1,2x6,5 mm
	861PE	○	3-4-5-6-8 mm
	861PH	⊕	PH0-PH1-PH2-PH3
	861TX	⊕	T8-T10-T15-T20-T25-T30-T40
	895/1	○	1/4" - 1/4"
	900	○	4-5-5,5-6-7-8-9-10-11-12-13-14 mm
	900/20		50 mm
	900/21		150 mm
	900/25		
	900/42		115 mm
	900BG/30		128 mm

## 900/C12M

reversible ratchet (900/55)

009000963 1,2 kg

€ 118,50 € 96,80



## 900/C12MR

reversible ratchet with rotating handle (900/58)

009000962 1,3 kg

€ 133,50 € 109,70



## 902A/C22

Assortment of 22 hexagon sockets and 6 accessories, in metal case



420x185x60 mm

14"		900	○	5-5,5-6-7-8-9-10-11-12-13 mm
		900/20		50 mm
		900/25		
12"		920A	○	10-13-14-15-17-18-19-22-24-27-30-32 mm
		920/21		125 mm
		920/25		
		920/55	⊕	

009020807 3,5 kg

€ 198,50 € 165,20





38

Assortment of 16 hexagon sockets and 5 accessories in foam tray, in metal case



335x145x60 mm

	910A	6-7-8-9-10-11 12-13-14-15-16 17-18-19-21-22 mm
	910/21	125 mm
	910/22	250 mm
	910/25	
	910/42	210 mm

### 910A/C16

reversible ratchet (910/55)



009100936 2,3 kg  
€ 160,00 € 129,90



### 910A/C16HR

reversible ratchet with rotating handle (910/58)



009100935 2,4 kg  
€ 176,50 € 146,80



12

Assortment of 17 hexagon sockets and 5 accessories in foam tray, in metal case



420x185x60 mm

	920A	10-11-12-13-14-15-16-17-18-19 20-21-22-24-27-30-32 mm
	920/21	125 mm
	920/22	255 mm
	920/25	
	920/42	305 mm

### 920A/C17M

reversible ratchet (920/55)



009200924 5 kg  
€ 184,00 € 151,20



### 920A/C17MR

reversible ratchet with rotating handle (920/58)



009200937 5,1 kg  
€ 201,00 € 167,30



34

### 928A/C12

Assortment of 12 hexagon hand sockets and 5 accessories, in metal case



530x220x80 mm

	928A	22-24-27-30-32-34-36-38-41 46-50-55 mm
	928/21	200 mm
	928/22	380 mm
	928/25	
	928/42	450 mm
	928/55	

009280955 13,5 kg  
€ 475,00 € 371,20





## 861PB

**New item** 1/4

Set of 6 bits in fabric bracelet with magnetic clasp

**Magnetic bit holder**



Allows bit to be changed with one hand

## MIX1

- ⊕ 861PH PH1 - PH2
- ⊕ 861PZ PZ1 - PZ2
- 861PE 4 - 5 mm



008610956 61 g  
~~€ 23,60~~ € 18,90

## MIX2

- ⊕ 861PH PH2
- ⊕ 861PZ PZ2
- ⊖ 861TX TX20 - TX25  
TX30 - TX40



008610966 61 g  
~~€ 24,20~~ € 19,40

## 860MIX/A10

1/4

Set of 10 bits with magnetic bit holder, in plastic case

- 860LP 0,5x3-1,0x5,5-1,2x6,5 mm
- ⊕ 860PH PH1-PH2 (x2)-PH3
- ⊕ 860PZ PZ1-PZ2-PZ3
- 882M1 ○ 1/4" - ● 1/4"



008600900 130 g  
~~€ 13,80~~ € 10,60



## 860/C27

1/4

Set of 25 bits, 1 connector and 1 reversible ratchet in plastic case



- 860LP 0,5x3-1,0x5,5-1,2x6,5 mm
- 860PE 2-2,5-3-4-5-6 mm
- ⊕ 860PH PH1-PH2(x2)-PH3
- ⊕ 860TX T6-T8-T10-T15-T20-T25-T30-T40
- ⊕ 860PZ PZ1 - PZ2(2x) - PZ3
- 860/55 100 mm
- 892/0



008600880 320 g  
~~€ 47,00~~ € 37,30

## 860MIX/A31

1/4

Set of 30 bits with magnetic bit holder in plastic case

- 860LP 0,5x3 - 0,6x4,5 - 0,8x5,5  
1,0x5,5 - 1,2x6,5 mm
- 860PE 2-2,5-3-4-5-6-8-10 mm
- ⊕ 860PH PH0 - PH1 - PH2 - PH3 - PH4
- ⊕ 860RTX T9-T10-T15-T20-T25-T27-T30-T40
- ⊕ 860PZ PZ1 - PZ2 - PZ3 - PZ4
- 882MSR/50 ○ 1/4 ● 1/4



008600902 320 g  
~~€ 43,00~~ € 33,40

## 860TX/A10

1/4

Set of 10 bits with magnetic bit holder, in plastic case

- ⊕ 860TX T7-T8-T9-T10-T15-T20  
T25-T27-T30-T40
- 882M1 ○ 1/4 ● 1/4

008600970 130 g  
~~€ 15,90~~ € 12,40



## 862F/A7

1/4

Set of 7 magnetic bits, hexagon sockets, in plastic case

- 862F ○ 5,5-6-7-8-10-12-13 mm

008620950 350 g  
~~€ 24,00~~ € 18,50



## 605E

14"

Click-type torque wrenches with reversible ratchets for right-hand and left-hand tightening torque accuracy:  $\pm 6\%$



UNI EN 26789 ISO 6789

	Nm	kgfm	lbf.in	■	L (mm)	g			
605E/5	1÷5	0,1÷0,5	10÷45	1/4"	190	180	006050105	<del>€ 138,50</del>	€ 108,30
605E/10	2÷10	0,2÷1,0	18÷90	1/4"	190	180	006050110	<del>€ 144,00</del>	€ 112,40

## 666N

14" 3/8" 12"

Click-type torque wrenches with reversible ratchets. For right-hand tightening torque accuracy:  $\pm 3\%$



UNI EN 26789 ISO 6789

	Nm	kgfm	lbf.ft	■	L (mm)	g			
666N/2	5÷25	0,5÷2,5	4÷18	1/4"	220	300	006660002	<del>€ 227,00</del>	€ 177,50
666N/2X	5÷25	0,5÷2,5	4÷18	3/8"	220	300	006660003	<del>€ 228,50</del>	€ 178,50
666N/5	10÷50	1÷5	7÷37	3/8"	325	660	006660005	<del>€ 145,50</del>	€ 113,60
666N/10	20÷100	2÷10	15÷75	3/8"	367	730	006660010	<del>€ 146,50</del>	€ 114,50
666N/10X	20÷100	2÷10	15÷75	1/2"	367	800	006660011	<del>€ 148,00</del>	€ 115,60
666N/20	40÷200	4÷20	30÷150	1/2"	465	1010	006660020	<del>€ 162,50</del>	€ 127,00
666N/30	60÷300	6÷30	50÷220	1/2"	581	1380	006660030	<del>€ 189,00</del>	€ 147,60



## 677/C

3/4"

Break-back torque wrenches with push-through ratchets, for right-hand and left-hand tightening, torque accuracy:  $\pm 4\%$ , in case



677/C100

UNI EN 26789 ISO 6789

	Nm	kgfm	lbf.ft	■	L (mm)	g			
677/C50	100÷500	10÷50	70÷350	3/4"	915	5,2	006770606	<del>€ 617,00</del>	€ 488,60
677/C70	150÷700	15÷70	100÷500	3/4"	1140	6,2	006770611	<del>€ 640,00</del>	€ 506,50
677/C100	300÷1000	30÷100	200÷750	3/4"	1470	7,5	006770615	<del>€ 760,00</del>	€ 609,00

## 682

Electronic digital torque meter with transducer Dynatester 682 to be used either clockwise or anticlockwise Remarkable reading accuracy

Supplied with serial output RS 232 for printers

682/60

10

682/400

22



### TECHNICAL FEATURES

Reading accuracy  $\pm 1\%$  of the read value

Available measuring units

Nm-dNm-cNm-Lbf.ft-Lbf.in-Ozf.in-Kgf.m-Kgf.cm-gf.cm

Supply range 90 to 264 V AC at 50/60 Hz

Dimensions 235x185x185 mm

Tolerance test according to norm ISO 6789

Acceptability range for each torque wrench tested

Display: menu available in 11 languages

Provided with all certificates required

Calibration certificate with UKAS traceability

	Nm	kg			
682/60	1.2÷60	5,9	006820006	<del>€ 3.770,00</del>	€ 3.210,00
682/400	8÷400	6,1	006820040	<del>€ 3.840,00</del>	€ 3.273,00

# 665

3/8" 12"

**Mechanical torque wrench with digital setting and reversible ratchet, for right-hand tightening, torque accuracy  $\pm 3\%$**

- Auto power off after 30" when torque is set under minimum torque threshold
- Display will remain on with set torque value
- Torque setting to decimal digit
- Power supply: 1 battery 3V (included)

**MADE IN ITALY**

## 665/SW

**Digital torque calibration device**

Device allows calibration of wrenches item 665 with help of torque meters 680 and 682, without having to dismantle wrench. Fitted with a micro USB port, for firmware updates.

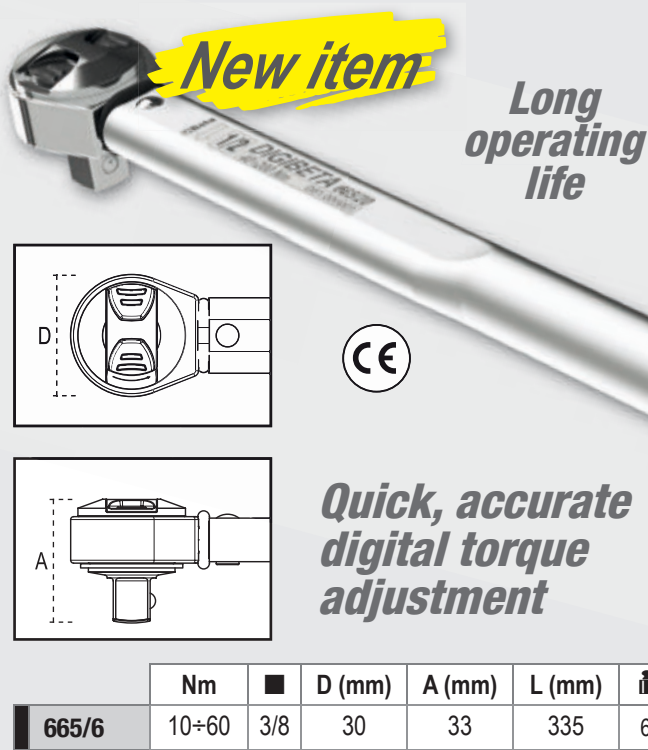

006650100 40 g  
~~€ 13,60~~ € 10,70

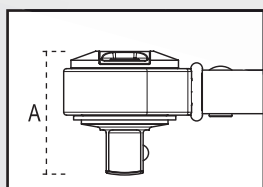
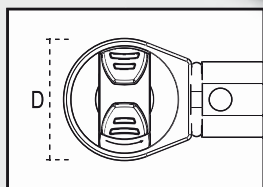

**Quick, accurate digital torque adjustment**

UNI EN 26789 ISO 6789

	Nm	■	D (mm)	A (mm)	L (mm)	g			
665/6	10÷60	3/8	30	33	335	655	006650006	<del>€ 145,50</del>	€ 113,60
665/10	20÷100	3/8	30	33	375	725	006650010	<del>€ 146,50</del>	€ 114,50
665/10X	20÷100	1/2	30	37	375	725	006650011	<del>€ 148,00</del>	€ 115,60
665/20	40÷200	1/2	40	43	470	995	006650020	<del>€ 162,50</del>	€ 127,00
665/30	60÷330	1/2	40	43	590	1260	006650030	<del>€ 189,00</del>	€ 147,60



# 560/...

**Torque multiplier for right-hand and left-hand tightening, in plastic case, ratio 3.8:1**

- multiplies tightening and untightening force
- only for use with torque wrenches
- maximum input torque: 395 Nm

**New item**



## 560/C3

**1500 Nm Max**

005600030 4 kg  
~~€ 647,00~~ € 512,00

## 560/C3PLUS

**2700 Nm Max**

005600038 7,5 kg  
~~€ 753,00~~ € 596,00





### 1169/D4

Set of 1 combination pliers, 1 long needle nose pliers, 1 cutting nippers and 1 slip joint pliers with boxed joints

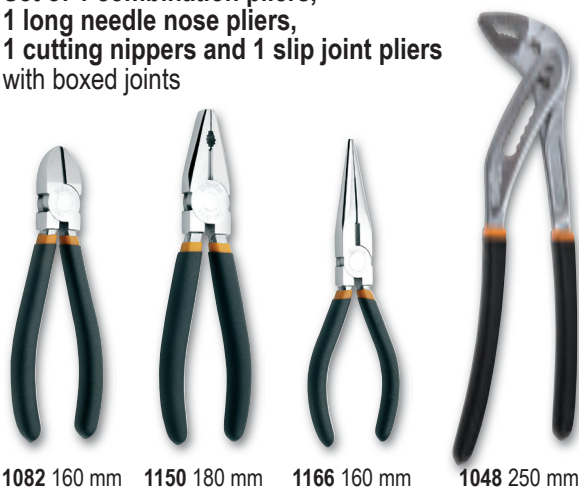

1082 160 mm    1150 180 mm    1166 160 mm    1048 250 mm

011690004    1,1 kg  
~~€ 64,50~~    € 53,60



### 1169BM/D3

Set of 1 combination pliers, 1 long needle nose pliers and 1 diagonal cutting nippers



1082BM 160 mm

1150BM 180 mm

1166BM 160 mm

011690123    700 g  
~~€ 58,00~~    € 48,80

### 1052

Adjustable self-locking pliers, concave jaws



	L mm	ø Max mm	g			
	1052/140	140	22	175	010520014	<del>€ 11,20</del> € 9,20
	1052/190	190	36	360	010520019	<del>€ 12,50</del> € 10,40
	1052/240	240	42	590	010520024	<del>€ 16,10</del> € 13,30

### 1057A

Automatic self-locking pliers with adjustable force



010570124    620 g  
~~€ 32,00~~    € 24,60

### 1031/S4

Set of 4 circlip pliers



1034 170 mm  
 ○ 19 ÷ 60 mm

1032 180 mm  
 ○ 19 ÷ 60 mm

1036 175 mm  
 ● 19 ÷ 60 mm

010310000    650 g  
~~€ 61,00~~    € 50,80



1038 175 mm  
 ● 19 ÷ 60 mm

## 1150INOX

Heavy-duty combination pliers, made of stainless steel

- Decentralized pin
- Open joint

180 mm

**Beta**  
**INOX**  
STAINLESS STEEL



**New item**

MADE IN ITALY

011500518 227 g  
~~€ 66,50~~ € 52,80



## 1150HPC

**New item**

Heavy duty combination pliers with integrated cutting edges and decentralized pin

Matt chrome-plated finish, bi-material handles, open joint

*Patent pending*

Hardness of M2 steel cutting edges =	<b>65HRC</b>
Shearing stress - static test =	<b>-73%</b>
Average life of cutting edges (test ISO 5744)	<b>+127%</b>

180 mm

**Matt chrome-plated finish**

- Absolutely groundbreaking
- remarkable cutting capacity

**Cutting edge hardness: 65HRC**

MADE IN ITALY

011500618 290 g  
~~€ 41,50~~ € 31,90



## 1047/240

Slip joint pliers, push button alignment

- Quick, accurate adjustment by pressing push button
- No accidental misadjustment
- Heat-treated jaws



L 240 mm    ø Max 36 mm    Max 32 mm

010470240 340 g  
~~€ 26,50~~ € 20,90

## 1048

Slip joint pliers, boxed joints

- Slip joint pliers, boxed joints

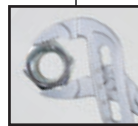

L 250 mm    ø Max 50 mm    Max 48 mm

010480015 370 g  
~~€ 18,00~~ € 15,00

## 1009L/DP-S2

Set of 2 extra-long, knurled double swivel nose pliers

- Suitable for jobs in hard-to-access areas



**L 340 mm**

010090060 920 g  
~~€ 43,50~~ € 34,20



### 412M/SP19

**New item**

Set of 19 twist drills with cylindrical shanks, HSS, AISI M2, entirely ground finishing

- Self-centring
- High performance and cutting accuracy
- For drilling alloy steel, cast iron and metal in general

Ø 1÷10 x 0,5 mm

R ≤ 850 N/mm<sup>2</sup>  
HV ≈ 820  
DIN 338

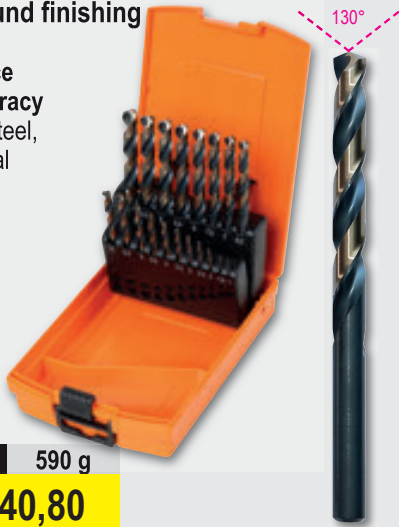

004120469 590 g

€ 52,00 € 40,80

### 415CO/SP19A

Set of 19 twist drills with cylindrical shanks, HSS-CO 5%

- For drilling holes into STAINLESS steel, alloy steel, cast iron, mild steel, light alloys

Ø 1÷10 x 0,5 mm

R ≤ 1400 N/mm<sup>2</sup>  
HV ≈ 850÷920  
DIN 338



115x170x40 mm

004150440 590 g

€ 93,00 € 72,80

### 412/SP25P

**New item**

Twist drills with cylindrical shanks, short series, HSS, entirely ground glossy finishing

Ø 1÷13 x 0,5 mm

R ≤ 700 N/mm<sup>2</sup>  
HV ≈ 750÷820  
DIN 338



004120415 1,1 kg

€ 79,50 € 63,00

### 426HS/SP10

Set of 10 rotary cutters made of HSS, 6-mm tang

- 5 coarse cutters: for light alloys, copper, brass and bronze
- 5 second-cut cutters: for steel and cast iron

**New item**



004260210 400 g

€ 185,00 € 144,40

### 446/C110

Assortment of 105 chrome-steel taps and dies, metric thread, and 5 accessories for car repair jobs in wooden case



500x337x60 mm

004460060 8 kg

€ 574,00 € 471,70



435/0 444/1 436/1  
435/3 444/2

III	III	III	III
430 M mm	433 M mm	440/440A M mm	441/441A M mm
2x0,4	6x0,75 - 7x0,75	2x0,4	6x0,75 - 7x0,75
3x0,5	8x0,75 - 8x1	3x0,5	8x0,75 - 8x1
4x0,7	9x0,75 - 9x1	4x0,7	9x0,75 - 9x1
5x0,8	10x0,75 - 10x1	5x0,8	10x0,75 - 10x1
6x1	10x1,25 - 11x0,75	6x1	10x1,25 - 11x0,75
7x1	11x1 - 11x1,25	7x1	11x1 - 11x1,25
8x1,25	12x0,75 - 12x1	8x1,25	12x0,75 - 12x1
9x1,25	12x1,25 - 12x1,5	9x1,25	12x1,25 - 12x1,5
10x1,5	14x1 - 14x1,25	10x1,5	14x1 - 14x1,25
11x1,5	14x1,5 - 16x1	11x1,5	14x1,5 - 16x1
12x1,75	16x1,5 - 18x1,5	12x1,75	16x1,5 - 18x1,5
14x2		14x2	
16x2		16x2	

### 425/SP3

Set of 3 stepped drills HSS

Ø 4÷30 mm



004250030 450 g

€ 196,50 € 153,60



## 31BM/D6

Set of 6 pin punches with handles

Ø 2-3-4-5-6-8 mm



000310420 805 g

~~€ 75,50~~ € 60,40

## 32AU

Automatic centre punches



L 150 mm

000320160 135 g

~~€ 36,50~~ € 27,70

## 1370

Mechanic's hammers  
wooden shaft



	g	g		<del>€</del>	€
1370/300	300	439	013700053	<del>€ 9,70</del>	€ 7,60
1370/500	500	669	013700055	<del>€ 11,80</del>	€ 9,20
1370/800	800	949	013700058	<del>€ 13,70</del>	€ 10,70
1370/1000	1000	1180	013700060	<del>€ 16,60</del>	€ 13,00
1370/1500	1500	1722	013700065	<del>€ 17,40</del>	€ 13,60
1370/2000	2000	2181	013700070	<del>€ 19,80</del>	€ 15,50

## 1370T

Mechanic's hammers  
fibre shaft



	g	g		<del>€</del>	€
1370T/300	300	452	013700630	<del>€ 12,80</del>	€ 10,50
1370T/500	500	663	013700650	<del>€ 14,80</del>	€ 12,20
1370T/800	800	1017	013700680	<del>€ 16,00</del>	€ 13,10
1370T/1000	1000	1279	013700700	<del>€ 19,50</del>	€ 16,00
1370T/1500	1500	1740	013700750	<del>€ 20,10</del>	€ 16,50

## 1390

Soft face hammers,  
wooden shafts



	Ø mm	g		<del>€</del>	€
1390/22	22	134	013900022	<del>€ 12,60</del>	€ 10,10
1390/28	28	230	013900028	<del>€ 15,60</del>	€ 12,50
1390/35	35	365	013900035	<del>€ 21,70</del>	€ 17,40
1390/45	45	698	013900045	<del>€ 34,00</del>	€ 27,40
1390/60	60	1462	013900060	<del>€ 58,00</del>	€ 46,50



## 1500N

Universal pullers with 2 sliding legs

	A min (mm)	A max (mm)	L (mm)			
1500N/0	18	65	70	015000600	<del>€ 45,00</del>	€ 35,60
1500N/1	23	70	100	015000601	<del>€ 45,50</del>	€ 36,10
1500N/2	23	100	100	015000602	<del>€ 46,50</del>	€ 36,70
1500N/3	35	140	150	015000603	<del>€ 78,00</del>	€ 62,00
1500N/4	35	190	150	015000604	<del>€ 85,00</del>	€ 67,20
1500N/5	43	250	205	015000605	<del>€ 171,00</del>	€ 135,20
1500N/6	43	320	205	015000606	<del>€ 182,50</del>	€ 144,50

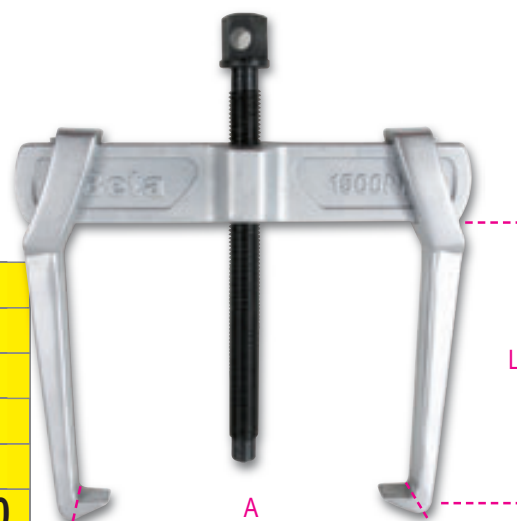

## 1430/S8

Set of 8 tapered extractors for broken screws and studs, made from hardened steel in plastic case

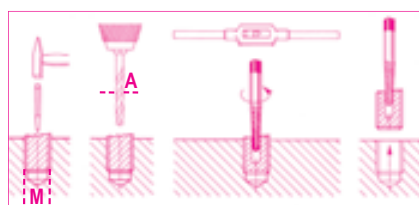

	M	A mm
1430/1	3÷6	2,5
1430/2	6÷8	3,0
1430/3	8÷11	4,5
1430/4	11÷14	6,0
1430/5	14÷18	8,0
1430/6	18÷24	11,0
1430/7	24÷33	14,0
1430/8	33÷50	21,0

014300108 745 g  
~~€ 55,50~~ € 43,80



## 1545/C5M

Puller 1542/1 with 5 extractors 1544, in metal case



265x180x45 mm

015450011 2,4 kg  
~~€ 340,00~~ € 255,80

	A mm	C mm
1544/1	9÷12	0,80
1544/2	13÷17	1,15
1544/3	16÷21	1,70
1544/4	20÷25	1,65
1544/5	25÷30	2,00

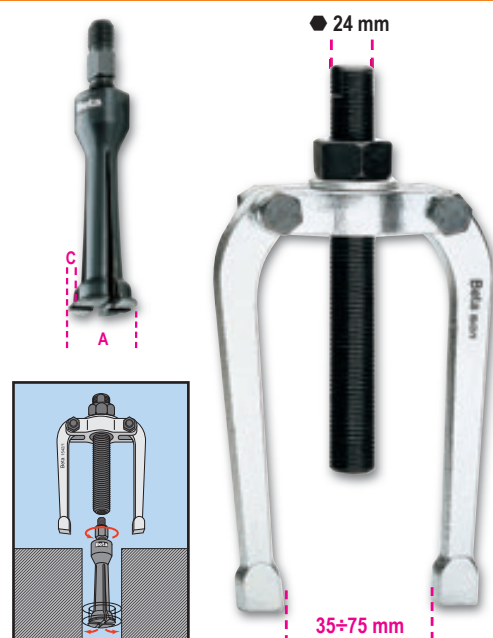

### 1651DGT

Digital vernier made from hardened stainless steel in hard plastic case

- Reading to 0.01 mm
- Screw slider locking
- mm/inch conversion



DIN 862  
UNI EN ISO 13385-1

### 1651DGT/150

A Max 150 mm L 225 mm

016510111 150 g  
~~€ 61,50~~ € 47,60

### 1651DGT/200

A Max 200 mm L 285 mm

016510112 425 g  
~~€ 102,00~~ € 73,50

### 1650

Sliding gauge made from hardened stainless steel

- Reading to 0.05 mm
- Spring locking

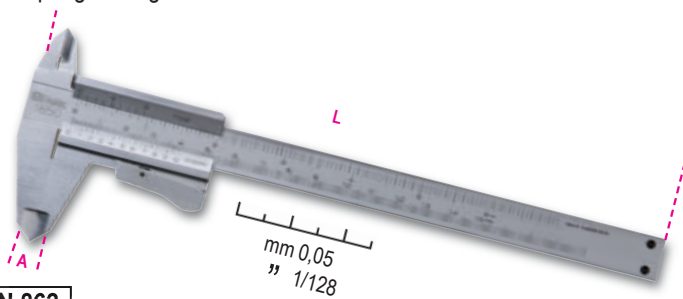

DIN 862  
UNI EN ISO 13385-1

### 1650/150

A Max 150 mm L 235 mm

016500001 170 g  
~~€ 42,00~~ € 32,90

### 1650/200

A Max 200 mm L 290 mm

016500002 230 g  
~~€ 57,00~~ € 43,80

### 1691BM

Measuring tapes shock-resistant bimaterial ABS casings, steel tapes, precision class: II

	L (m)	S(mm)	⚖ (g)	📦		
1691BM/5	5	25	275	016910205	<del>€ 5,95</del>	€ 4,70
1691BM/8	8	32	490	016910208	<del>€ 11,60</del>	€ 9,20
1691BM/10	10	32	630	016910210	<del>€ 14,70</del>	€ 11,60

### 437P

Thread dresser, for repairing internal and external, right-hand and left-hand threads P 0,80÷3,00 mm



004370003 122 g  
~~€ 31,00~~ € 24,00

### 437U/09

Assortment for repairing damaged threads

M5X0,8  
M6X1,0  
M8X1,25  
M10X1,5  
M12X1,75



004370550 2 kg  
~~€ 245,00~~ € 191,40 370x230x55 mm

### 1726BM

Hacksaw frame with quick release blade attachment system

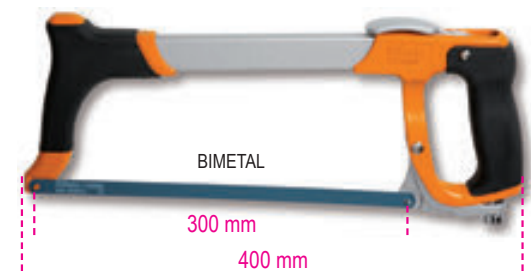

017260050 800 g  
~~€ 31,50~~ € 25,00





## 1606T

Crimping pliers for tubular terminals, 4-sided crimping



016060005 450 g  
~~€ 211,50~~ € 171,50

0,1÷10 mm<sup>2</sup>

## 1149F

Front wire stripping pliers with cutting blade, self-adjusting



011490010 500 g  
~~€ 10,50~~ € 8,10

0,2÷6 mm<sup>2</sup>

## 1760/RMS

Industrial digital multimeter accurate and sturdy, in a 6-mm co-moulded shell, with antislip, shockproof outer rubber part

- Water protection IP67
- Protection up to 1000V
- Tested for accidental falls up to 2 m
- Protected inlets • Autoranging
- Large direct reading display, backlit, blue
- K type temperature probe (included)
- Self-power down
- Rubber terminal base for enhanced operating comfort
- Double insulated terminals, 1000V, 1 m long
- Supplied in a soft case
- CAT IV 600V/ CAT III 1000V
- Actual effective value TRUE RMS



	Measuring range	Base accuracy
AC/DC voltage	110mV – 600V ±0.8%	- ±2% rdg
AC/DC current	110µA – 10A ±1.5%	- ±2% rdg
Resistance	110Ω – 40MΩ ±1.2%	- ±2.5% rdg
Capacity	11nF – 40mF ±5%	- ±10% rdg (up to 11mF)
Frequency	1100Hz – 110 MHz ±1.2%	- ±1.5% rdg
Temperature	-32°C – +1000°C ±3%	- ±5% rdg
Diode test	3V DC ±10% rdg	
Continuity test	<30 Ω	

017600020 800 g  
~~€ 208,50~~ € 164,10



## 1609B

Mechanical crimping pliers

- For noninsulated copper terminals, 10÷120 mm<sup>2</sup>
- Antislip rubber handle
- Internal "H" section pin for unparalleled punch smoothness
- Made from burnished steel



10÷120 mm<sup>2</sup>

016090101 4,2 kg  
~~€ 224,50~~ € 176,60

## 1256/C36-2

Bi-material microscrewdriver with 36 interchangeable 4-mm bits and magnetic extension

	1256TX	⊖	T3-T4-T5-T6-T7-T8-T9-T10-T15
	1256RTX	⊕	T6-T7-T8-T9-T10
	1256LP	●	0,8-1,2-1,5-1,8-2-2,5-3-3,5-4 mm
	1256PE	○	0,7-0,9-1,3-1,5-2 mm
	1256PH	⊕	PH000-PH00-PH0-PH1
	1256PZ	⊕	PZ000-PZ00-PZ0-PZ1
	1256/20		
	1256/30		

130x60x35 mm



012560100 200 g  
~~€ 42,00~~ € 33,20

## 1740B 330

Compact heavy-duty riveting pliers

- Optimized lever ratio for increased compactness and handiness.
- 3 jaws lock rivet for a perfect grip.
- Adjustable head for pulling rivet by 2 to 5 leg movements.

2,4÷6,4 mm steel



**3 jaws:  
improved  
rivet grip**



*With  
stem tank*

017400330 1 kg

€ 50,50 € 39,20

## 1749AC

High thrust gun for chemical binders



230 mm  
STANDARD Ø 50 mm

017490005 1 kg

€ 25,50 € 20,40

## 1749A

Bonding gun, professional model  
aluminium tube



017490010 803 g

€ 27,00 € 20,90

## 1741B

Riveting pliers supplied  
with 4 interchangeable  
nozzles



017410000 600 g

€ 24,80 € 19,60

## 1741U

Ultra compact riveting pliers  
with adjustable force  
with 4 interchangeable nozzles



**3 jaws:  
enhanced  
rivet grip**



L 200 mm

017410450 450 g

€ 29,00 € 22,30

## 1750

Lever operated grease guns, 500 cc



**550 Bar**

017500500 1,2 kg

€ 28,50 € 21,50



## 7042LCD

Auto-darkening LCD mask, for electrode welding; MIG/MAG; TIG and plasma. Solar cells power supply and lithium batteries for outstanding LCD filter life

- Viewing area: 98x43 mm
- Darkening shade: DIN 9-13, externally adjustable
- UV/IR protection
- Light to dark time: 1/25000 s
- Dark to light time: 0.25-1s
- Adjustable darkening sensitivity and delay
- Auto on/off
- Grinding feature
- Optimized shape to make it easier to breathe with pulled-down screen



070420001 900 g  
~~€ 127,50~~ € 99,50

## 1860 160A

DC inverter welding machine for MMA and TIG electrode steel welding. Compact and easy to carry. Arc force, hotstart, anti-sticking and thermostatic protection features



Adjustment current:	5÷160A
Power supply:	1 x 230V
Use factor (40°C):	30% - 160 A 60% - 130 A 100% - 110 A
Delayed fuse:	25A
Protection:	IP23S
Use with generators:	✓
Use with generators:	25 mm <sup>2</sup>
Usable electrodes:	Ø 1.5 - 4 mm rutile, basic, stainless steel, cast iron etc.

018600006 7,8 kg  
~~€ 642,00~~ € 508,00

## 1860SQ

Magnetic square, 45°/90°

- Ideal for locking tubular or flat parts
- 40 kg magnetic force
- No battery required, ON/OFF effect obtained by tilting interior magnets
- Easier chip removal with magnets in OFF position



018600210 700 g  
~~€ 57,50~~ € 46,10





## 1852R1750

### Portable induction heater

- heats and loosens stubborn bolts, hubs and bearings without using flames
- allows any type of ferromagnetic metal to be heated

### Maximum safety without using flames



480x370x130 mm

### Technical data:

- input voltage: 230V AC, 50/60 Hz
- input current: max. 7.5 A
- power: max. 1.75 kW

### BENEFITS

- 1 - Time saving:** quick, extremely accurate heating
- 2 - Fire safety:** does not produce flames, maximum operator safety
- 3 - Functional:** can be used with one hand, and coils can be easily interchanged

### FIELDS OF APPLICATION

- Automotive industry
- Industrial maintenance
- Aviation industry
- Naval industry
- Petrochemical industry

### Standard equipment:

- two front attachable coils, Ø 19 and 26 mm, for loosening nuts **1**
- one flat coil for heating surfaces **3**
- one flexible coil, 800 mm long **2**
- supplied in plastic case

018520175

4,5 kg

€ 1.057,00 € 836,50

## 1827F

### Butane gas soldering iron

- 35 g tank
- three interchangeable nozzles: 550 °C; 1000 °C; 1300 °C
- supplied with a stand in hard case



*For deforming plastics and unlocking metal parts*

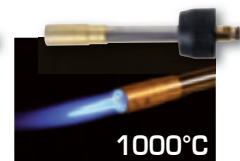

018270200

1,5 kg

€ 97,50 € 77,40

## 1870

### Solid and fluid vacuum cleaner, 20 l

### Technical data:

voltage:	230/240 V
frequency:	50/60 Hz
max. power:	1200 W
airflow rate:	58 l/sec.
max. suction power:	190 mbar
max. drum capacity:	20 l
acoustic emissions:	<70 dB(A)
cable length	5 m

### Equipped with:

corrugated hose:	✓
hard tubes:	✓
multiuse brush:	✓
flat nozzle:	✓
rubber fitting inside Ø	x
<b>FILTERING SYSTEMS</b>	
air filter cartridge:	✓
anti-foam filter:	✓
bag:	x



**Non-marking wheels**



018700020

6,9 kg

€ 164,00 € 129,70



### 334

Pipe cutter for copper and light alloy pipes

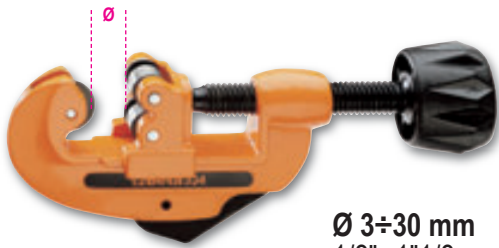

Ø 3÷30 mm  
1/8"÷1 1/8"

003340001 292 g  
~~€ 18,70~~ € 14,20

### 342

Ratchet-type shears for plastic pipes



003420030 500 g  
~~€ 34,00~~ € 27,10

Ø 0÷42 mm  
1 5/8"

### 363

Heavy duty pipe wrenches made from light alloy



	L (m)	Ø (")	Ø (mm)			
363 350	350	2" gas	60	003630035	<del>€ 39,00</del>	€ 30,80
363 450	450	2 1/2" gas	76	003630045	<del>€ 52,00</del>	€ 41,30
363 600	600	3" gas	90	003630060	<del>€ 95,50</del>	€ 75,70
363 900	900	5" gas	140	003630090	<del>€ 153,50</del>	€ 121,60

### 352U

Adjustable tube flaring tool for copper and light alloy pipes



Ø 5÷16 mm  
3/16"÷5/8"



003520101 860 g  
~~€ 60,50~~ € 48,10

### 186 8-32

Self-locking wrench with automatic take-up device for hexagons, 8 to 32 mm

Ideal for hexagon, Spline, square and Torx® head screws, including damaged screws.



001860008 560 g  
~~€ 38,00~~ € 28,70

## 1838COB

Compact rechargeable inspection lamp with ultra-brightness LED. Lithium polymer battery

- Compact body made of antislip rubber
- Swinging hook
- Magnetic base can be rotated 180 degrees
- With charger 100-240Vac / 50-60Hz
- 100/200 lumens - spot 75 lumens
- Operating range: 5 / 2.5 hours
- IP65



018380010 200 g  
 € 68,00 € 49,60



## 1836A

LED headlamp, dual brightness, with contactless ON/OFF sensor

- 120/65 lumens
- IP54
- Batteries: 3xAAA included



018360050 215 g  
 € 35,50 € 28,30

## 1834P...

High-brightness LED torch, made of sturdy

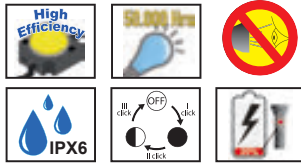

### 1834P XL

1350 LUMEN  
 018340330 300 g  
 € 62,50 € 49,60  
 3xD Not included

### 1834P L

500 LUMEN  
 018340325 270 g  
 € 50,00 € 39,70  
 1xAAA 2xAAA 3xAAA Not included

### 1834P M

350 LUMEN  
 018340320 120 g  
 € 29,50 € 23,60  
 1xAAA 2xAAA 3xAAA Not included

### 1834P S

300 LUMEN  
 018340310 56 g  
 € 24,20 € 19,20  
 2xAAA Not included



Matt finish

## 1838SLR

Rechargeable, articulated LED inspection lamp

- Compact front LED (200 lumens) and head LED (100 lumens) for inspections
- Lighting body no more than 9 mm thick
- Operating range: 5/2.5 hours (depending on light level setting)
- With USB charger
- With metal hook and magnet
- IP80

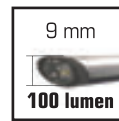

Compact and versatile

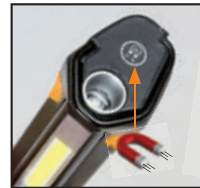

018380201 200 g  
 € 72,50 € 56,70





# 1837C

Rechargeable LED spotlight for building yards

- 3 brightness settings
- battery charger: input: 100-240V AC - 50/60Hz; output: 15V 1.5A
- charging time: 4 hours
- 3-LED charge indicator
- can rotate up to 180°
- IP65
- IK07



**New item**



## 1837C/2100

500/1000/2100 lumen



220x225x70 mm

018370210 1,1 kg

€ 112,00 € 88,90



## 1837C/4300

1100/2200/4300 lumen



266x236,6x59 mm

018370430 1,3 kg

€ 167,50 € 132,80

# 1838FLASH

Rechargeable, ultracompact spotlight, designed to offer the best possible solution for each use

- IP65 - without external power supply
- Dual brightness: 650 / 300 lumens
- Lithium polymer battery 7.4 V 4000 mAh



90°



### ABUNDANT READY LIGHTING:

with a maximum lighting capacity of 720 lumens, and running on both battery and cable, it is always ready to use



360°

1/4"

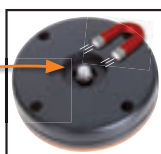

12V



230V

5 m

018380300 820 g  
€ 258,00 € 193,70



85x100x155 mm

# 1837S

Telescoping tripod for worklight

- Made of metal
- Adjustable height: 70÷155 cm

Compatible with items 1837C and 1838FLASH



**New item**



018370500 2,4 kg

€ 34,00 € 27,10

## 1778S0S

Car service knife with window breaking hammer and seat belt cutter features, in case

- with clip and fabric wallet with loop
- anodized aluminium handle
- safety blade lock



017780080 184 g  
~~€ 17,20~~ € 13,60

## 1771HD *New item*

Utility knife, 18 mm, supplied with 6 blades

- Automatic blade change
- Screw blade locking system



017710100 170 g  
~~€ 14,20~~ € 11,00

## 1772M

Safety utility knife with retractable blade,

- supplied with 3 blades
- Blade retracts through an automatic spring mechanism
  - die-cast alloy body
  - staple remover built into handle



Adjustable cutting depth  $\varnothing \pm 25$  mm

017720040 160 g  
~~€ 12,50~~ € 9,90

## 1838/11LED

Rechargeable inspection lamp with ultra-high brightness LEDs, lithium polymer battery

- Compact body made of antislip rubber
- With charging station, 110-230Vac
- With multidirectional head LED



018380111 700 g  
~~€ 105,00~~ € 82,10



## 1842LED/ABM

Lamp with ultra-high brightness LEDs, 12-24 V; AC-DC

- Compact body made of antislip rubber
- Easy-to-replace front glass
- Swinging hook
- With multi-directional head LED light



018420311 1,1 kg  
~~€ 89,00~~ € 69,60

## 1846LED/BM

Automatic cable reel with LED inspection lamp, 100-240 Vac

- With 230/24 V safety transformer
- Max. 25 W



018460301 5,8 kg  
~~€ 280,00~~ € 218,80

## 1848

Automatic cable reel with Schuko type socket

- Max. 1600 W with unwound cable
- Max. 1200 W with wound cable
- Crush-resistant rubber cable H07 - 3x1.5 mm<sup>2</sup> - 15m



018480015 5,2 kg  
~~€ 295,00~~ € 221,60



## 1128FXS

Electrician's scissors with graduated milling profiles, straight stainless steel blades, with microteeth, cable cutting groove and crimping pliers for tube terminals

- Articulated belt hook case
- Bimaterial handles
- Anti-loose pin
- Profile and mill: designed to enlarge holes on plastic, from 13 to 21 mm



011280095 80 g

€49,10 € 15,10

**New item**

**Patented**

### A new perspective

To redesign our electrician's scissors, we observed users' daily work. We have made it into a universal tool, incorporating the 4 main features into one object.

#### CUTTING

quick and sharp, for cables up to 50 mm<sup>2</sup>, with a cable cutting groove and a microtoothed blade, for improved hold.

#### STRIPPING

the sensitive anti-loosening pin allows even the thinnest cables to be accurately stripped.

#### CRIMPING

safe and durable, for tube terminals.

#### COUNTERSINKING

the unique milling profile allows the holes in pull boxes to be countersunk accurately and neatly.



**With cable cutting and crimping function**

## 1128FX

Electrician's scissors, straight stainless steel blades, with microteeth, cable cutting groove and crimping pliers for tube terminals

- Articulated belt hook case
- Bimaterial handles
- Anti-loose pin

011280090 80 g

€47,80 € 13,90

## 1128BAX

Double-acting electricians' scissors, with milling profiles in DLC-coated stainless steel

- High blade surface hardness (resistance to abrasion and wear)
- Low coefficient of friction (smoothness and anti-adherence)
- With articulated plastic case



**+hardness  
-coefficient  
of friction**

011280088 160 g

€20,60 € 16,30

**Patented**



**Profile and mill:** designed to enlarge holes on plastic, from 13 mm to 25 mm.



### 3050/600

#### Electro-hydraulic motorcycle jack, 600 kg

Technical specifications

- Electrical, mechanical and hydraulic safety devices
- Capacity: 600 kg
- Integrated electro-hydraulic unit: 230V - 50 Hz
- Hydraulic pump
- Controlled downward speed
- Safety fuses for protection in case of cable cuts
- control push button panel
- CE-certified, TÜV-approved



198 kg

3050    030500201    030500202    030500203    ~~€ 4.010,00~~    € 3.177,00

### 9562T3

*New item*

#### Garage mat, 300x160 cm

- Particularly suitable for use under motorcycle jacks
- Protects floor from oil and petrol leaks, environmentally friendly
- Easy to clean, anti-skid, rubber-coated bottom



095620300    4,8 kg

~~€ 231,50~~    € 197,30

### 3040C

#### Rear motorcycle stand, adjustable

- Matt black lacquer
- 4 thermoplastic rubber wheels
- Includes V-shaped sliders, pair
- Includes L-shaped sliders, pair



030400002    4,8 kg

~~€ 58,00~~    € 45,50

### 3043C

#### Motorcycle stand with left single arm

- Matt black lacquer
- 4 thermoplastic rubber wheels



030430002    6,5 kg

~~€ 67,50~~    € 52,60

### 3041C

#### Front motorcycle stand, adjustable

- Matt black lacquer
- 4 thermoplastic rubber wheels
- Includes roller sliders, pair
- Includes cone-shaped sliders, pair



030410002    5 kg

~~€ 51,50~~    € 40,20



## 3932U

Professional chain tool compatible with chains from 5 to 11 speeds

**New item**



039320011 210 g  
~~€ 34,50~~ € 27,50

## 3935

**Chain wear indicator**

- Suitable for checking chain elongation with "passes/does not pass" system.
- 0% ÷ 0.75%: chain does not need to be replaced.
- 0.8% ÷ 1%: chain needs to be replaced.
- A worn chain makes poor shifting and accelerates sprocket wear.

**New item**



039350010 31 g  
~~€ 4,10~~ € 3,20

## 3937

**Missing link pliers**

- 2PVC handle
- Useful for removing and installing missing link

**New item**



039370010 153 g  
~~€ 11,10~~ € 8,80

## 3967

**Sprocket removal wrench with chain whip**

- Caters for up to 11 speed cassettes
- 2PVC handle
- Also suitable for fixed wheels

Also suitable for fixed bicycles

**New item**



039670010 245 g  
~~€ 41,50~~ € 32,80

## 3912P

### PRO workshop workbench for bicycle maintenance

- With support for central movement
- Bicycle can be fixed without rear wheel
- Supports specially designed for BMX bicycles

**New item**



039120110 21 kg

~~€ 589,00~~ € 466,10

## 3927

### Handlebar clamp

- A must-have tool for maintenance jobs on stands without fork clamps

**New item**



039270010 405 kg

~~€ 18,50~~ € 14,60

## 3948

### Crank extractor

- For 14mm nuts

**New item**

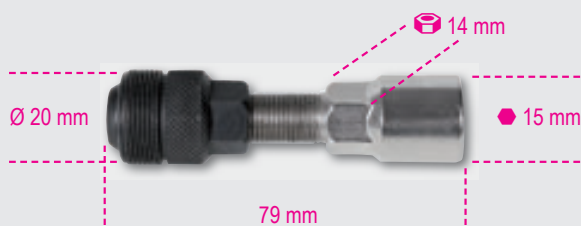

039480015 114 g

~~€ 9,15~~ € 7,20

## 3969

### Steel tyre lever

- For heavy duty jobs
- 200 mm long
- Orange handle
- Suitable for heavy duty jobs

**New item**



039690010 79 g

~~€ 5,80~~ € 4,60





## 1273MQ/D6



Set of 6 screwdrivers

1274MQ ● 3x100-4x100-5,5x125 mm

1272MQ ⊕ PH0x60-PH1x80-PH2x100 mm

**1000 V**

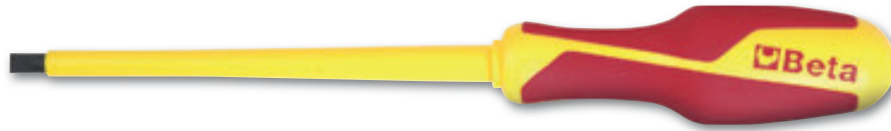

012730851 500 g

€ 43,50 € 34,60

## 1273MQ/F-D6



Set of 6 slim screwdrivers

1274MQ/F ● 0.5x3,5x100 - 0.8x4,5x100 -

1x5,5x125 - 1.2x6,5x150 mm

1272MQ/F ⊕ PH1x4.5x80- PH2x6x100 mm



**1000 V**



012730406 500 g

€ 41,00 € 32,40

## 1760/OHM

Multimeter/megohmmeter for high voltage insulation testing. TRUE RMS indicator



CAT. IV 600V  
CAT. III 1000V

### Measuring range

AC/DC voltage: 50mV - 1000V  
AC/DC voltage: 0.01µA - 10A  
Resistance: 0.01Ω - 50MΩ  
Meg OHM: 0.01 - 5000MΩ  
Capacity: 5nF - 10mF  
Frequency: 50Hz - 100 MHz  
Temperature: -50°C - +1350°C  
Diode test: 3V dc  
Continuity test: <30 Ω

### Base accuracy

±0.06% - ±0.1% rdg  
±0.5% - ±1% rdg  
±0.2% - ±2% rdg  
±4% rdg. max current 1mA  
±1.5% - ±3% rdg  
±0.02% - ±0.1% rdg  
±0.5% rdg

017600025 500 g

€ 596,00 € 456,70

## 1169MQ/D2

Assortment of insulated combination pliers and insulated diagonal cutting nippers

**1000 V**



1150MQ 180 mm

1082MQ 160 mm



011690143 600 g

€ 61,50 € 48,70

## 2115P L-MQ32

Assortment of 32 insulated tools for hybrid cars, in plastic tool box with soft thermoformed tray



021150332 6,7 kg  
 € 723,00 € 564,80

### Quantity/Description

- 1 1/2" reversible ratchet
- 1 single ring wrenches 10-12 mm
- 1 magnetic bit holder, insulated 1/4"
- 10 set of 10 bits with magnetic bit holder
- 1 1/2" square drive extension bar 125mm
- 7 hexagon sockets 8-10-12-13-14-17-19 mm
- 1 1/2" square drive extension bar 125mm
- 1 1/2" square drive extension bar 250mm
- 1 slip joint pliers, boxed joint 250mm
- 1 combination pliers 1000V = 180mm
- 1 extra-long bent flat nose pliers = 160mm
- 2 screwdrivers for cross head Phillips® screws, 1000V
- 3 screwdrivers for headless slotted screws, 1000V
- 1 insulating gloves, made from latex G2
- 1 tool box, long series, made from plastic

- Beta N.**
- 920MQ/55A
  - 89MQ
  - 850MQ
  - 860TX/A10
  - 920MQ/A
  - 920MQ/21
  - 920MQ/22
  - 1048MQ 250
  - 1150MQ
  - 1164MQ160
  - 1272MQ
  - 1274MQ
  - 1995MQ/G2
  - CP15L

## 5988VHB-MQ

Assortment of 66 insulated tools, 1000V, in soft foam trays

**New item**

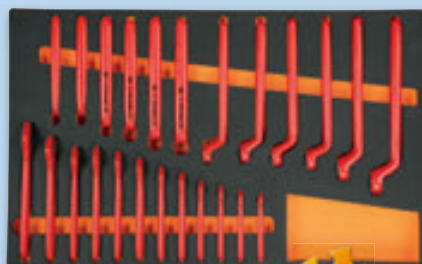

M49

24



M108

27



M161

15

### Quantity/Description

- 12 single open end wrenches, 1000V 7-8-10-11-12-13-14-15-16-17-19-22 mm
- 12 single ring wrenches 7-8-10-11-12-13-14-15-16-17-19-22 mm
- 4 socket drivers for hexagon screws 4-5-6-8 mm
- 11 bi-hex sockets 7-8-10-11-12-13-14-15-16-17-19 mm
- 6 socket drivers for Torx® head screws T15-T20-T25-T27-T30-T40
- 2 socket drivers with XZN® profile 8-10 mm
- 1 3/8" drive extension 125 mm
- 1 3/8" drive extension 250 mm

### Beta N.

- 52MQ
- 89MQ
- 910MQ/PE
- 910MQ/B
- 910MQ/TX
- 910MQ/XZN
- 910MQ/21
- 910MQ/22

### Quantity/Description

- 1 3/8" drive, T-handle
- 1 3/8" drive reversible ratchet
- 1 electrician's scissors
- 1 slip joint pliers, boxed joint 250 mm
- 1 diagonal cutting nippers 1000V 160 mm
- 1 combination pliers 1000V = 180 mm
- 1 extra long flat nose pliers = 160 mm
- 1 extra-long bent flat nose pliers = 160 mm
- 4 screwdrivers for cross head Phillips® screws, 1000V
- 4 screwdrivers for headless slotted screws, 1000V
- 1 cable stripping knife, insulated

### Beta N.

- 910MQ/T
- 910MQ/55
- 1128MQ
- 1048MQ
- 1082MQ
- 1150MQ
- 1162MQ
- 1164MQ
- 1272MQ
- 1274MQ
- 1777MQ/U

059880400 6,2 kg  
 € 1.720,00 € 1.395,00



## 7103K4

**New item**

Barrier kit for hybrid or electric vehicles waiting to be repaired, comprised of 4 90 cm-high posts and 1 25 m long plastic chain



071030001  
 € 89,00 € 68,00

## 7109/S7

**New item**

Set of 7 electrical hazard signs, aluminium frame



071090107  
 € 51,00 € 40,60



## 1498/16A

### Electronic multipurpose battery charger, 12-24V

- backlit graphic display
- max. charging current: 16A, continuous
- charging and charge maintenance
- protected against polarity reversal and short circuits
- 9 charging steps
- floating system
- SHOW ROOM function (13.8V - 12A)
- SUPPLY function (14V - 12A)
- memory saving function (13.8V - 12A)
- battery recovery function
- clamp holder
- reclining hook fastening
- supplied accessories: cable with clamp, cable with eyelets



**New item**

#### TECHNICAL DATA

Power supply: 220-240V  
 Power: 240W  
 Charging current: 4-16A  
 Battery types: Agm - Wet - Lithium (LiFePo4)

Charging capacity: 5-360Ah  
 Maintenance capacity: 5-550Ah  
 Output voltage: 12-24V  
 Minimum battery voltage: 0.8V  
 Degree of protection: IP20

014980126 2 kg

€ 324,00 € 253,00

## 961P6

### Electronic videoscope with flexible probe

Allows videos or individual images to be directly recorded on instrument



- Supports SD cards (8 GB)
- Supports flash memories (8 GB)
- Internal memory: 128M
- TV-OUT feature
- Supports video formats (MP4, AVI, 3GP)
- 4 LEDs
- Power supplied by USB port (built-in battery)



#### SPECIFICATIONS

- Sensor pixels: 640x480
- Maximum resolution: 320x240
- Probe length: 1 m
- Camera diameter: 6 mm
- Video formats: MPEG4, 3GP, AVI, ASF.
- Photo formats: JPEG
- Shooting angle: 0÷180°
- Data output: USB cable and SD card
- Power supply: 3.7V 2000 mAh battery

009610000 2 kg

€ 535,00 € 418,10

## 1498/8A



### Electronic car / commercial vehicle battery charger, 12 V

Protected against polarity reversal and short circuits

- Digital backlit display
- Pull-back fixing hook
- Rated current (min-max): 1-4 A (1498/4A); 2-8 A (1498/8A)
- Battery capacity: 4-80Ah (1498/4A); 5-160Ah (1498/8A)
- Power supply function 13,8V-5A



Power supply voltage	220V-240V
Frequency	50-60 Hz
Rated current (Min-Max)	2-8 Amp
Battery voltage	12V
Battery capacity	5Ah-160Ah
Degree of protection	IP65
Battery type	Wet-Gel-Dry-AGM

014980108 1,2 kg

€ 153,00 € 119,70



## 1760PA/AC-DC

### Amperometric clamp and digital multimeter



#### SPECIFICATIONS

DC voltage: 0.1mV ÷ 600V  
 AC voltage: 0.1mV ÷ 600V  
 AC current: 0.01A ÷ 1000A  
 DC current: 0.01A ÷ 1000A  
 Resistance: 0.1Ω ÷ 40MΩ  
 Capacity: 0.001nF ÷ 40 μF  
 Frequency: 0.001kHz ÷ 4kHz  
 Temperature: -40°C ÷ 1000 °C  
 -40°F ÷ 1832°F

017600000 660 g

€ 247,00 € 186,80





## 1760/IR500

**New item**

**Digital infrared thermometer with dual laser aiming system**

**TECHNICAL DATA**

Temperature range: -50 ÷ 500 °C (-22 ÷ +932 °F)  
 Display resolution: 0.1 °C (0,1 °F)  
 Emissivity: 0.1 ÷ 1 adjustable  
 Accuracy: -50 °C ÷ +20 °C (+/- 3 °C);  
 20 ÷ 500 °C (+/-2% or 2 °C)  
 Optical resolution (D:S): 12:1  
 Auto power off: ca. 10 seconds  
 Operating temperature: 0 °C ÷ 50 °C  
 Storage temperature: -20 °C ÷ 60 °C  
 Power supply: 1.9V battery

**500°C**



017600350 350 g

€ 113,50 € 88,70

## 1497/C23

**Assortment of 23 tools for releasing electrical connectors**



014970200 1,5 kg

€ 157,00 € 122,90

## 1498TB/12-24

**Digital battery tester, 12V, and starting/charging system analyzer, 12-24V**

- allows the following to be tested: battery, alternator (smart and normal) and starter, diode ripple and chassis test
- fitted with software for printing test from PC
- compact, shockproof frame
- complete with input for connecting a removable mini printer (optional accessory, Beta 1498ST/TB)



**10 language software**

Applications	- 12V battery test - Alternator charge test, 12-24V - Starter test
Operating range	100-2000 CCA
Reference standards	CCA,SAE,DIN,EN,IEC,JIS
Supported batteries	PB, WET, GEL, AGM, AGM FLAT, EFB
Voltmeter	9V-36V
Cable length	1600 mm
Languages	Italian, English, French, German, Spanish, Polish, Romanian, Dutch, Swedish and Finnish
Accessories included	USB cable and software

014980401 1,5 kg

€ 482,00 € 376,80

435x320x100 mm



## 1498LT/12



Portable high-performance starter, ultralightweight  
Includes memory save



4000A

**Weighs no more than 2.5 kg!**

Operating voltage	12V
Continuous amperage	800A
Maximum pickup amperage	2000A
Peak amperage	4000A
Cable length	500 mm
Battery type	YES
Memory saving function	ANO
Dimensions:	260x135x72 mm
Complete with charging power supply	12 V 1,3A

014980012 3,4 kg  
€ 632,00 € 494,30



## 1498/24



Portable car and commercial vehicle starter, 12-24V

- Pickup current: 4200A (12V) - 2100A (24V)
- Sealed lead acid battery, solid electrolyte (AGM) type



014980490 17 kg  
€ 849,00 € 663,80



## 1498MN/12



Multipurpose portable starter

- Motor vehicle starting with 12-volt battery (diesel and petrol engines up to 2,000 cc)
- Charging of tablets, mobile phones and electronic devices in general
- Multi-use LED torch



Pickup current	600A
Battery type	5V 1A-2A
Starting output	12 Volt



240x185x60 mm

014980000 542 g  
€ 258,00 € 201,40

## 1498/40A



Multipurpose battery charger starter, 12-24V wheeled

- Specific WET-SPIRAL/GEL-AGM charging cycles
- Electronic control and protection system
- Battery desulfurization and recovery function
- Supply function
- Also suitable for Start&Stop batteries



**2 in 1  
battery charger  
+ starter**

Power supply:	230V
Output voltage:	12-24V
Charging current:	1-40A
Starting current:	350A max cc
Charging capacity:	4-450Ah



014980140 8,5 kg  
€ 832,00 € 650,40





Can be used as a mobile workstation for diagnostic tools, laptops, testers and battery chargers

- Painted sheet metal frame: unparalleled firmness and sturdiness
- Ergonomic handle
- 2 fixed rear castors Ø 160 mm
- 2 steering front castors Ø 125 mm (one with brake)

## CA49-G

Multi-purpose trolley with door, empty

049000112 36,5 kg

€ 539,00 € 426,50

## CX49-G

Multi-purpose trolley, empty

049000102 36 kg

€ 469,00 € 378,20



2-level top

2 central shelves with adjustable position and 1 fixed low shelf



Pull-out drawer for housing a mini keyboard



4 useful side cable reels made of plastic



2 useful side containers



1 paper holder



1099 mm  
460 mm  
435 mm

## 1897

**New item**

Professional bench sander

The cabin is equipped with the following:

- loading door with magnet closure
- perforated sheet metal top
- standard connection for vacuum cleaners, Ø 36 mm
- protective polycarbonate viewing window, 6 mm
- LED lamp
- pneumatic circuit (compressed air inlet)
- sanding gun with trigger operation



MADE IN ITALY

018970066 38 kg

€ 2.620,00 € 2.046,00

Useful dimensions of cabin	600x520x320 mm
Overall dimensions	660x530x500 mm
Worktop	perforated sheet metal
Lighting	LED
Air consumption	340 l/min at 7 atm
Power supply	220 V - 50 Hz

## 1897/KSA

**New item**

Bench sander item 1897, complete with vacuum cleaner item 1871M/AS



60 l/s  
35 l

M class

018970660 49 kg

€ 3.460,00 € 2.706,00

## 1897/CRB

**New item**

Corundum for sander 1897 in 25 kg bag



018970101 25 kg

€ 133,00 € 103,90

## 1897/MV

**New item**

Glass microspheres for sander 1897 in 25 kg bag



018970103 25 kg

€ 175,00 € 136,80

## 1897/G

**New item**

Garnet for sander 1897 in 25 kg bag



018970104 25 kg

€ 106,50 € 83,40





# 1465

**New item**

## Engine efficiency tester

Allows endothermic engine compression to be tested within just a few seconds, without requiring connection to engine, taking power from vehicle battery, through a dedicated software.

### TECHNICAL DATA

Operating voltage: 12V DC (vehicle battery)  
 Dimensions: 140x75x30 mm  
 Clamp cable length: 1300 mm

**Takes just a few seconds to test compression!**



Step 1	Calculating engine rpm
Step 2	Testing battery voltage trend during each revolution
Step 3	Displaying absorbed power and compression calculated through starter operation for each piston
Step 4	Testing battery charge and efficiency

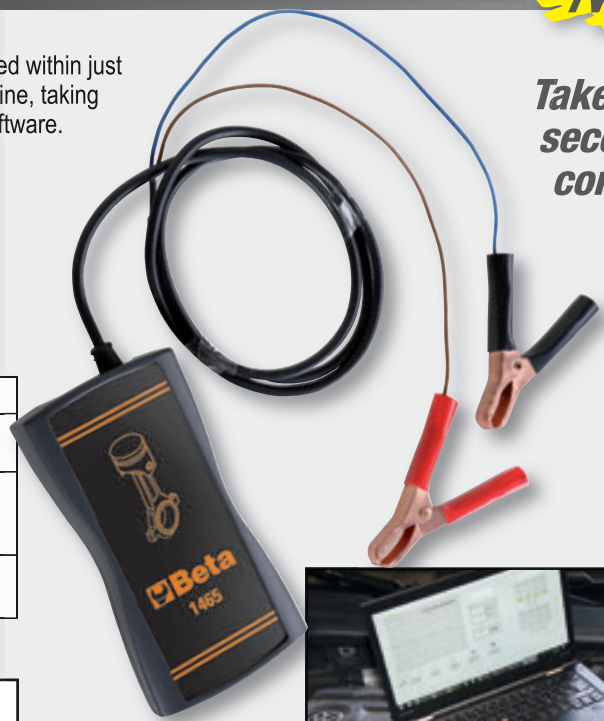
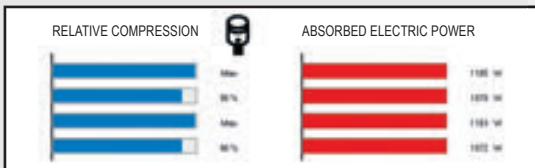

014650010 365 g  
 € 866,00 € 676,70

**MADE IN ITALY**

# 1760/RSE

**New item**

## Signal detector

Allows power supply of parts to be tested, including

- Common rail electro-injectors
- Petrol/LPG electro-injectors
- Piezoelectric injectors
- Flow regulating solenoid valves
- EGR solenoid valves and coils

Performing diagnosis of individual parts of electric system only requires probe to be brought near part being tested.

In systems with electromechanical/electronic parts controlled by a control unit, this tool makes it possible to check whether:

- Control unit is being supplied with power and is performing its control function
- Cables connecting control unit to part is efficient
- Part being tested has not being disconnected
- Part has not short-circuited
- Part is operating electronically

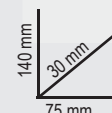

017600170 365 g  
 € 342,00 € 267,10

**MADE IN ITALY**

## 989A

Pliers for removing wheel balancing adhesive weights  
Nose profile specially designed to remove weights without making contact with rim

*No risk of damage*

*New item*



009890011 400 g

€ 23,30 € 18,20

## 1471M/C22

Pneumatic tool for pushing back and rotating right and left disc brake pistons with accessories, in plastic case

- Automatic jack
- Thrust: 150 kg
- Operating pressure 5+8 bar

350x310x85 mm



014710101 3,8 kg

€ 167,00 € 127,10

## 1567

Lever for removing wishbone heads and shock absorbers from pillar

One operator can position lever effortlessly and proceed with disassembly



*It is enough to apply a force of 20 Nm*

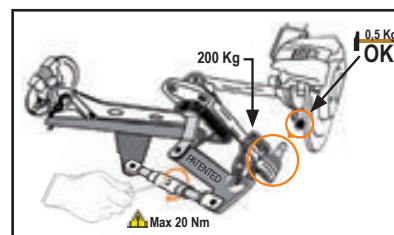
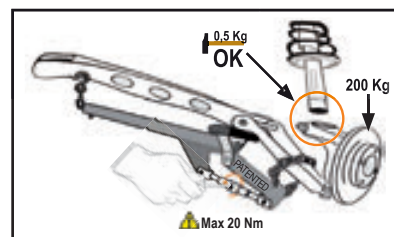

015670001 5,5 kg

€ 237,50 € 185,80

## 720LC/C3

3 impact sockets for wheel nuts, with polymeric inserts, in plastic case

○ 17-19-21 mm



148x132x44 mm

007200653 800 g

€ 24,80 € 18,10





## 1464T

Digital pressure and compression tester



**SPECIFICATIONS**

- 5" touch screen display
- rechargeable polymer lithium battery
- complete with 80 bar sensor (for low pressure) and USB cable

014640050 1,1 kg

€ 567,00 € 443,60

## 1464PB



Set of 9 connectors for testing fuel low pressure (for use with item 1464T)

Quick connectors to tester 1464T allow fuel low pressure in diesel and petrol engines to be quickly checked



530x440x120 mm

014640700 3,8 kg

€ 410,00 € 320,50

## 1464IC



Set of dummy injectors and dummy glow plugs for item 1464T

Makes it possible to connect to the engine to check compression in diesel engines with digital tester 1464T.

- 22 dummy glow plugs
- 5 dummy injectors
- 1 universal dummy injector kit for trucks, marine engines and agricultural machines



559x312x50 mm

014640350 4,5 kg

€ 372,00 € 290,50

## 960AD/TP2



Set of adaptors for item 1464T

- Dummy injectors
- Dummy glow plugs
- Spark plug adaptors
- Oil cap adaptors
- Petrol injection couplers
- Set of spare gaskets



430x310x50 mm

009600510 3,7 kg

€ 325,00 € 253,90

## 1464AP



Set for testing high pressure system in common rail diesel engines, with item 1464T

- High pressure pipe set
- Fittings
- 2,000 bar sensor



430x310x50 mm

014640450 1,8 kg

€ 492,00 € 384,30



## 1464VD

**New item**

### Vacuum testing set for item 1464T

For measuring and storing maximum vacuum value

Supplied with:

- 800 mbar sensor
- 6 and 8 mm adaptors
- 3-m-long RJ45 cable

#### TECHNICAL DATA

Vacuum test: 0÷800 mbar

Resolution: 1 mbar

Maximum value storage



240x210x50 mm

014640570 317 g

€ 142,00 € 110,90



## 1464FAP

**New item**

### Set for testing diesel particulate filter (DPF) pressure for item 1464T

Supplied with:

- 500 mbar sensor
- 8 mm adaptor with quick coupling and T fitting
- 3-m-long RJ45 cable

#### TECHNICAL DATA

Pressure test: 0÷500 mbar

Resolution: 1 mbar



240x210x50 mm

014640610 328 g

€ 142,00 € 110,90



## 1464ADB

**New item**

### Set for testing AdBlue® system pressure for item 1464T

Supplied with adaptors for use with 80-bar standard sensor supplied with item 1464T

240x210x50 mm

014640620 237 g

€ 65,50 € 51,10



## 1880ADB

### Rotary AdBlue® pump

- 5 litres supplied every twenty turns
- drum extensions up to 1.20 m
- 1 fine-pitch drum coupling, fine pitch
- 1 coarse-pitch drum coupling

**New item**



018800101 1,95 kg

€ 94,50 € 74,10

## 1759HD/3

### Cooling system seal testing and circuit filling tools

Make it possible to check circuit (pipes, joints, pumps, radiators) for leaks under pressure and quickly fill circuit, avoiding air bubble formation

600x500x140 mm



017590063 6,8 kg

€ 380,00 € 297,30



## 960KPC

14"

Reversible impulse extractor with adjustable torque for glow plugs

- Pneumatic extractor with adjustable torque and special sockets allow jammed glow plugs to be unscrewed, thereby minimizing damage risk
- 5 1/4" impact sockets, long series, specially designed for glow plugs: 8-9-10-11-12 mm, 2 extensions and 1 articulated joint
- 4 adjustable driving torques: 10-20-30-40 Nm
- Right-hand and left-hand adjustment



009600780 2,9 kg

€ 219,50 € 171,50

420x185x60 mm

## 960EPC/L

Set of tools for removing glow plug electrode face M8x1 - M9x1 - M10x1 - M10x1,25

Allows glow plug tip to be removed when breaks occur during disassembly and head remains stuck in cylinder.

Long version

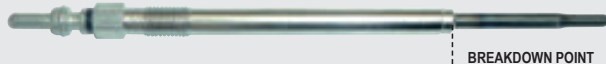

BREAKDOWN POINT

New item

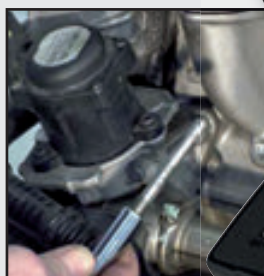

009600890 2 kg

€ 632,00 € 493,80

## 960KC-M8/M9/M10

Assortment of tools for removing broken or damaged glow plugs

For spark plugs with threads M8-M9-M10



009600801 2,5 kg

€ 293,00 € 229,20

380x290x50 mm

## 1462/EI

Universal vibration tool for injector removal

- Helps to fully remove jammed injectors from their housings, without damaging cylinder heads and without breaking injectors
- Can be used with any injector removal set, with or without hammer face
- Tool acts directly on removal tie rod, which is coupled with injector, through vibrations and pulses
- Control valve allows vibration intensity to be adjusted to type of work to be carried out

### COMPONENT PARTS

- 1 adapter for inclined grip
- 1 inclined adapter
- 1 adapter for orthogonal grip
- 2 screws
- 1 pneumatic valve



New item



014620240 2,2 kg

€ 491,00 € 384,10



## 1438EVO

### Universal clutch aligning kit

Kit contents:

- flywheel alignment bushings  
ø 10-12-14-15-16-17-19-25-27-30 mm
- 1 clutch cover aligner
- 2 clutch disc alignment cones
- 3 threaded guide pins
- 2 expansion aligners  
ø 15÷19 mm  
ø 20÷27 mm

**Component parts made  
entirely from metal**

**New item**



014380011 1,9 kg

€ 178,50 € 139,50

290x200x60 mm

## 960/C6

### 3/8" female drive hexagon sockets for removing/installing exhaust gas temperature sensors

Kit contents:

- 3 short sizes, 13, 14, 17 mm
- 3 long sizes, 13, 14, 17 mm

**High  
strength**

**New item**



009600055 800 g

€ 55,50 € 43,80

## 1462/KI

### Assortment of common rail diesel injector pullers

Allows DELPHI-BOSCH-SIEMENS-DENSO injectors to be removed

- Mechanical and hydraulic operation
- Includes one 12-t hydraulic jack
- Can be directly used on vehicle with mounted engine
- Numerous adjustment options on head  
make it possible to work on most engines available

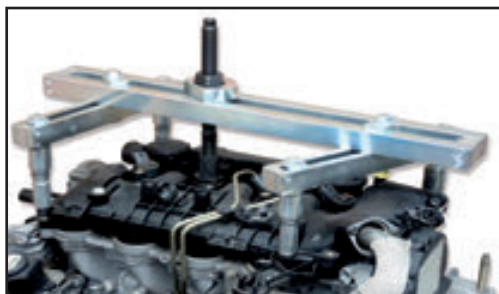

014620235 20 kg

€ 1.735,00 € 1.358,00

530x470x140 mm





# 1895G

MADE IN ITALY

**New item**

## Control generator for (petrol and LPG) electro-injectors and solenoid valves

Makes it possible to autonomously test efficiency of such parts as:

- EGR solenoid valves
- Electro-injectors of petrol and LPG engines
- Solenoid valves for variable-geometry turbine adjustment
- Compressors for new-generation air conditioners



### BENEFITS

- Makes it possible to understand whether part is working mechanically
- Combined with ultrasonic cleaning tanks, it allows more efficient cleaning of parts, electronically controlling part during washing phase
- Essential for air conditioner testing, to check whether compressor and its control valve are efficient

### SPECIFICATIONS

Petrol and LPG injector control:

- Number of outlets: 4
- Test duration: 1-60 s
- Operating time: 5-10 ms
- Impulse frequency range: 1-10 Hz

PWM device control:

- Number of outlets: 1
- Test duration: 1-60 min
- Automatic or manual
- Duty cycle adjustment: 10%-85%
- Signal frequency regulation: 120-250 Hz

Includes 4 connectors with female FASTON terminals  
Power supply: 110-220 V

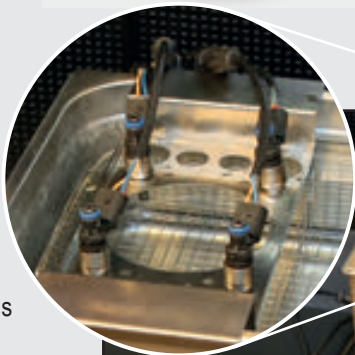

018950800 4 kg

€ 1.310,00 € 1.024,00



# 1497/C94

Assortment of 94 car testing connectors  
For use with main diagnostic tools

**Complete with 2 t-taps**

Assortment contents:

- 2 t-taps
- 2 potentiometers
- 2 warning lights
- 2 SRS connectors
- 2 alligator clips
- 2 acicular probes
- 2 prods
- 2 dual banana connectors
- 4 single banana connectors
- 24 flat male terminals 0.6÷6 mm
- 12 round male terminals 1.6÷3.9 mm
- 24 flat female terminals 0.6÷6 mm
- 12 round female terminals 1.6÷3.9 mm



014970300 3 kg

€ 271,00 € 212,20

430x390x100 mm

# 1895

## Ultrasonic cleaning tank with special degas function

- Ultrasonic cleaning relies on fluid heating to effectively clean spare parts and metal pieces in general (carburetors, valves etc.)
- Digital display for temperature and cleaning time selection
- Two cleaning modes: "soft" and "normal"
- For normal cleaning, just use water at a temperature of 50/60 °C
- For more accurate cleaning, add non-foaming detergent solutions (type Arexons Fulcron Extra) specific for ultrasonic tanks
- Using the degas mode speeds up air release throughout the tank, thereby improving ultrasonic cleaning efficiency



### 1895 6    1895 13    1895 27

Tank capacity	6 l	13 l	27 l
Drain tap	✓	✓	✓
Power	150 Watt	300 Watt	500 Watt
Heating power	300 Watt	400 Watt	500 Watt
Temperature range	0÷80°C	0÷80°C	0÷80°C
Cleaning time range	0-99 minutes	0-99 minutes	0-99 minutes
Frequency	40 kHz	40 kHz	40 kHz
Power supply	220/230V	220/230V	220/230V
Dimensions	330x180x310 mm	350x325x320 mm	530x330x380 mm



**Ideal for injectors and EGR valves**



## 1895 6

### 6 l

018950060    8,1 kg  
 € 498,00    € 389,20

## 1895 13

### 13 l

018950130    12,5 kg  
 € 782,00    € 611,00

## 1895 27

### 27 l

018950270    13,5 kg  
 € 1.103,00    € 862,00

## 1895/S

### Adjustable support for ultrasonic cleaning tanks 1895

Allows injectors to be correctly placed during washing in ultrasonic cleaning tank

**New item**

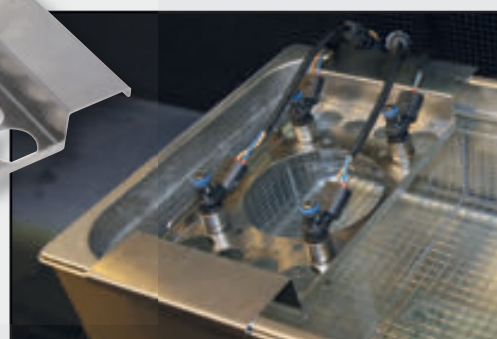
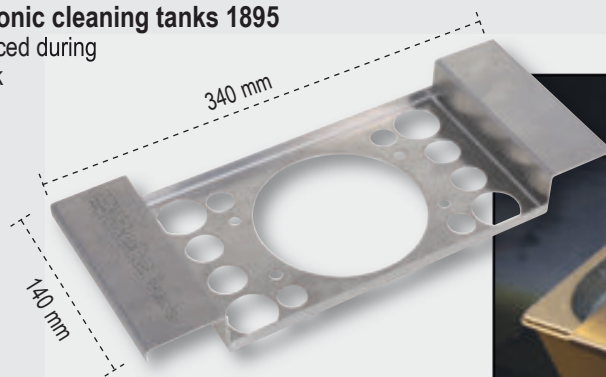

018950501    410 g  
 € 79,00    € 61,70



**1885**

**MADE IN ITALY**

***New item***

**Automatic gearbox maintenance station**

Allows entire washing cycle to be safely performed in all automatic transmissions, through a simple, guided procedure. Avoids damage from wear of oil in automatic gearbox, thereby easily and quickly preventing typical malfunctions, including: excessive gearbox noise, jammed gears, abruptly engaged gears, long gear shifting time.

**FUNCTIONAL SPECIFICATIONS**

- Automatic operation
- Step-by-step guided procedure with integrated database
- Balancing quantity of injected oil with same quantity of exhausted oil, thereby making sure that system always contains proper quantity of oil
- Flow meter for visual inspection of oil quantity
- Printing records of each operation

**AUTOMATIC SPECIFICATIONS**

- Injecting solvent (optional)
- Washing gearbox system
- Emptying oil out of sump
- Emptying oil out of converter
- Injecting oil into converter

**TECHNICAL SPECIFICATIONS**

- Power supply: 220 V 50 Hz
- Backlit oil viewers with 2 white light LEDs
- 2 electronic balances
- Electronic balances, resolution +/- 10 g
- Electronic card with backlit graphic display



***Database included***

***Fully automatic***

018850010 70 kg  
 € 6.440,00 € 5.029,00

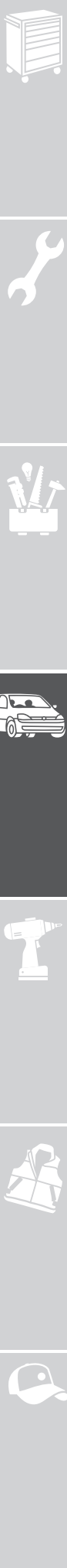



# 1893

MADE IN ITALY

**New item**

## Automatic charging station for air conditioners

Fully automatic model, complete with car/lorry database with gas quantities, compressor oil quantities and types, self-diagnosis software for routine maintenance jobs. Database can be updated via software.

Machine can be operated in both manual mode (provided it is controlled by a human operator step by step) and in fully automatic mode (without requiring a human operator).

### FUNCTIONAL SPECIFICATIONS

- Automatic operation
- Car/lorry database with gas quantities and compressor oil quantities and types
- Automatic gas recovery from pipe
- Compensation of recharged quantity of gas in pipes
- Automatic discharge of noncondensable gases
- Automatic reporting of defects and required maintenance jobs
- Gauges, ø 80 mm
- Digital vacuummeter

### TECHNICAL SPECIFICATIONS

- Gas tank: 15 kg
- Vacuum pump: 75 l/min
- Electronic balance: 50 kg
- Electronic card with backlit display
- Recovery rate: 500 rpm
- Power supply: 220 V



## Gas R134A

### 1893/134A

018930001 70 kg

€ 4.730,00 € 3.695,00

gas tracer R134A (250 ml) included



## Gas R1234YF

### 1893/1234YF

018930012 70 kg

€ 4.890,00 € 3.822,00

gas tracer R1234YF (250 ml) included

## 1893TR/CI

Gas tracer



**New item**

018930903 300 g

€ 39,50 € 30,70

## 1879 6

Manual operation fluid extractor, 6 l

- 3 hard pipes that can be connected to each other
- 1 hose specifically designed for brake oil bleeding



**New item**

018790000 3,7 kg

€ 165,50 € 129,30



# Oil drain units

- level indicator
- big diameter pan with breakwater grate; capacity: 12 l
- pneumatic tank emptying through 1.8 m pipe

## 1877

Exhausted oil drain unit, wheeled, with 90 l tank



01877008 23 kg  
 € 502,00 € 392,30

## 1877A

Exhausted oil drain unit / vacuum cleaner, wheeled, with 90 l tank and pre-chamber

- Transparent pre-chamber: capacity 9.5 l
- 1.8-m suction pipe

Standard accessories:

- 1 hard probe, Ø 5x700 mm
- 1 flexible probe, Ø 5x700 mm
- 1 hard probe, Ø 6x600 mm
- 1 flexible probe, Ø 6x700 mm
- 1 flexible probe, Ø 7x700 mm
- 1 flexible probe, Ø 8x700 mm
- adapters for VW, BMW, CITROËN



01877008 29,5 kg  
 € 880,00 € 687,50

## 1491

Adjustable oil filter wrench

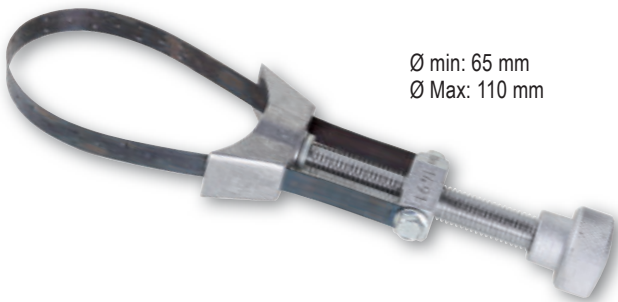

Ø min: 65 mm  
 Ø Max: 110 mm

014910001 450 g  
 € 30,50 € 23,00

## 1493/C7

Self-adjusting oil filter wrench with three arms for right- and left-hand tightening, with interchangeable arms

- 2 sets of arms:
- 1 set with 20 mm working length
  - 1 set with 38 mm working length



Ø mm  
 50÷100

Antislip  
 diamond  
 finish



014930079 600 g  
 € 82,50 € 64,50

210x150x50 mm

## 1490F

38" 12"

Strap wrenches for filters

**New item**



Ø Max: 200 mm

014900201 250 g  
~~€ 20,10~~ € 15,70

## 1493VW

12"

Diesel oil filter wrench,  
for VAG and Volvo cars

**New item**



014930086 130 g  
~~€ 10,10~~ € 7,90

## 1494BMW

38"

Special socket for plastic oil drain plugs,  
for BMW engines

- 10 mm
- 17 mm

**New item**



014940315 30 g  
~~€ 7,95~~ € 6,20

## 1494FPC

38"

Special socket for plastic oil drain plugs, for  
Ford, Peugeot and Citroën engines

- 17 mm

**New item**



014940320 40 g  
~~€ 8,90~~ € 7,00

## 1494VW/K

Engine oil replacement kit,  
for VAG cars

**New item**

Kit contents:

- 1 special socket for plastic oil drain plugs
- 6 plastic oil sump plugs



014940310 120 g  
~~€ 21,20~~ € 16,60

## 1491A

**New item**

Adjustable oil filter pliers  
Precision adjustment through rack

- Ø min: 55 mm
- Ø Max: 140 mm



014910040 620 g  
~~€ 24,10~~ € 18,80

## 1493H

Self-adjusting oil filter wrench with 3 arms,  
for right and left hand tightening  
Knurled jaws

38" 12"

**New item**



014930077 550 g  
~~€ 17,40~~ € 13,60

## 1491T

**New item**

Adjustable truck oil filter pliers  
Precision adjustment through rack  
For use with drier filters

- Ø min: 70 mm
- Ø Max: 200 mm



014910050 1,5 kg  
~~€ 56,00~~ € 43,80





**1758**

**Self-adapting funnel**  
Particularly useful for cars with no depth in inlet pipes

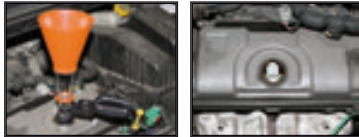

017580020 400 g  
~~€ 37,50~~ € 29,40

**1758B**

**Non-return funnel with quick couplings**  
Particularly suitable for VAG cars



**New item**

**Non-return**

017580030 500 g  
~~€ 25,00~~ € 19,70

**CB52-0**

**Gearbox/transmission trolley with liquid recovery system**  
Inclined plane and drain holes allow liquids to be recovered in collection tank

- Fitted with:
- 4 swivel castors, including 2 with brakes
  - tool drawer
  - pull-out liquid collection tank; capacity: 7 l
  - 2 shelves

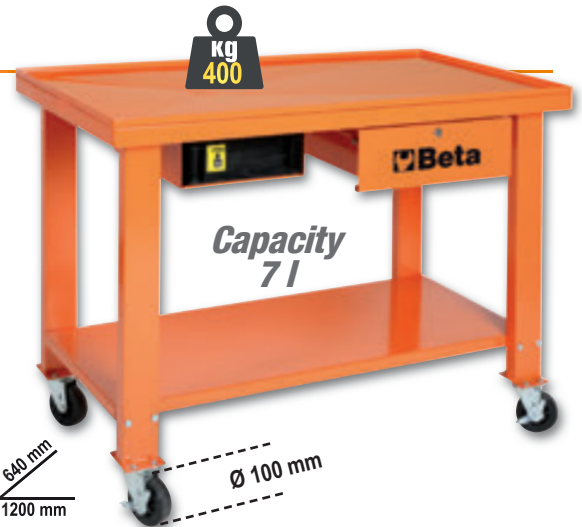
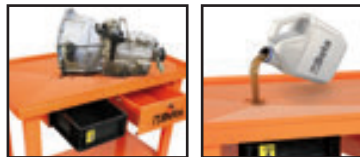

052000201 60 kg  
~~€ 478,00~~ € 373,70

**1756G**

**New item**

**Diesel oil gun capacity: 1.5 l**

- Can be used to:
- fill diesel oil filters
  - fill Cerina tank

- Kit contents:
- 2 pipes with female quick couplings for connecting diesel oil pipes
  - 2 male quick couplings, made of metal
  - 1 cone-shaped adapter for rubber pipes



1500 ml

017560615 850 g  
~~€ 87,50~~ € 68,30

**Polypropylene suction guns**

- Also suitable for braking system fluid
- Operating temperature: +0 - +50 °C
- NOT suitable for fuel

**200 ml**

Double EPDM gasket



**1756C**

017560502 250 g  
~~€ 21,70~~ € 17,20

**1500 ml**

Double NBR gasket

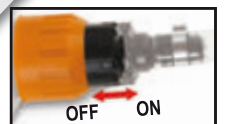

**1756D**

017560515 690 g  
~~€ 49,00~~ € 38,70

# 1884

## Oil filler tool for manual and automatic gearboxes and differentials

Complete with 12 adaptors for direct connection

- Fitted with nonreturn valve for leakage-free oil filling
- Delivery: 70 cc per pump shot
- Tank capacity: 7.5 l
- Maximum permissible oil viscosity: SAE 140

018840010 4,8 kg

€ 353,00 € 261,90



12 ADAPTORS

FORD	AT-101
UNIVERSAL (Bmw, Honda, Nissan...)	AT-102
VW-AUDI	AT-103
VW-AUDI-PORSCHE	AT-104
VW-AUDI-MINI COOPER	AT-105
MERCEDES	AT-106
DSG	AT-107
VW-AUDI CVT	AT-108
VOLVO	AT-109
TOYOTA-LEXUS	AT-110
SKODA	AT-111
VW Passat/Tiguan <2007	AT-112

# 1466/C5

## Kit of 5 brake bleeding wrenches

Kit contents:

- 5 wrenches sizes 7-8-9-10-11 mm
- 1 drain hose with check valve



Oil goes into bush

260x170x50 mm



014660100 700 g

€ 90,00 € 70,20

# 1466L 11

**New item**

## Brake bleeding wrench, 11 mm, long version

Long version

014660211 90 g

€ 22,70 € 17,70



# 1466TLF

## Brake oil recovery tank capacity: 1.5 l

Quick coupler for bleeding pipe  
Ø 5.5 mm

014660201 300 g

€ 32,50 € 25,40



**New item**

# 1485TC

**New item**

## Tensioning lever for service belts, mounted on Ford, PSA, FCA engines



014850330 680 g

€ 34,00 € 26,70

# 1472MT/VW

**New item**

## Pair of claws for disconnecting suction manifolds in VAG cars

Can be used on turbocharged petrol engines 1.0 - 1.2 - 1.4



014720500 100 g

€ 7,60 € 5,90

# 1482D

## Quick coupler pliers for fuel pipes, with flexible extension

**New item**



014820026 500 g

€ 63,00 € 49,20





## 3035

### Tyre trolley

- For easily transporting tyres up to 980 mm in diameter
- The sturdy frame allows tyres to be handled without bearing the weight physically
- Can be used as a top by locking position horizontally
- 2 castors Ø 260 mm
- 2 castors Ø 125 mm
- Maximum transportable height: 1.60 m
- Maximum carrying capacity: 200 kg
- Forks can be adjusted in 2 positions:  
first position: maximum opening 880 mm  
second position: maximum opening 980 mm



030350100 30 kg

€ 685,00 € 528,50

## 3036

### Wheel handling base Non-marking rubber castors

**Max 150 Kg**



Ø 630 mm

030360063 4,2 kg

€ 87,50 € 68,30

**New item**





## 1550U

**Pneumatic shock absorber removal tool for cars, SUVs and commercial vehicles**

- upper universal hold system
- active safety system on spring
- protective "full body" grille

Supplied with 2 lower forks for diameters 78-205 mm

TECHNICAL DATA

Maximum thrust:

2 tons (10 bars) - 1.6 tons (8 bars) - 1.2 tons (6 bars)

Spring compression stroke: 335 mm



Maximum thrust 2 tons (10 bar)

1670 mm  
825 mm  
610 mm



## 1550U/SS187

**Left-hand fork for item 1550U**

Particularly suitable for left-hand springs, e.g. Nissan Qashqai and Renault Koleos



015500018 4,4 kg

€ 270,00 € 211,00

## 1550U/M

**Vice for shock absorber removal tool item 1550U**

Allows shock absorber stem to be locked



015500021 4 kg

€ 243,50 € 190,40

## 3009

**Wheel lifter**

Maximum lifting capacity: 550 kg

- 4 pivoting rollers
- Roller width: 200 mm
- For wheels up to 240 mm in width



**Ideal for:**

- loading damaged cars onto tow trucks
- car repair garages
- moving cars in showrooms

030090001 21,8 kg

€ 279,00 € 218,40

## 1479/B 27

**Kit of 27 nylon tools for removing pins and working on plastics and seals**

Convenient hanging wallet for viewing all tools



014790407 900 g

€ 55,50 € 43,80



## 2254F

### Car front protector

Allows front part of vehicle to be protected, while leaving openings for headlights and radiator

- Waterproof
- Resistant to oil and grease
- Strap fixing
- Material: 98% polyamide/nylon, 2% polyurethane



022540150 800 g

~~€ 60,50~~ € 47,50



## 1360/KP3

**New item**

Hammers with ball heads and point peins/punches, made of plastic

Kit contents:

- 1 210 g hammer with head Ø 30 mm
- 1 290 g hammer with head Ø 40 mm
- 1 75 g punch with 5 mm pein



013600503 580 g

~~€ 57,50~~ € 45,00

## 1365/K13

Oil pressure pump, 10 t, and bodywork accessories kit in handy trolley

Kit contents:

- oil pressure pump and piston
- wing opening pliers
- L-shaped base
- male-to-male coupling for installing accessories



900x420x180 mm

013650013 33 kg

~~€ 494,00~~ € 386,40

## 2254SV

### Reusable seat and steering wheel protector

Suits most car seats and steering wheels

- One size fits all
- Reusable and washable
- Made of hard-wearing nylon with stretch strings
- Material: 98% polyamide/nylon, 2% polyurethane



022540100 170 g

~~€ 19,30~~ € 15,10

## 1361/C12

**New item**

Set of Teflon® rods for body repair shops

275x160x57 mm



013610012 600 g

~~€ 90,50~~ € 70,90

## 1479ML/S3

**New item**

Kit of 3 multipurpose wrecking bars, made of plastic  
Particularly recommended for precision jobs



014790603 15 g

~~€ 7,35~~ € 5,80

## 2254T

**Kneeling pad**  
Made from non-slip EVA foam



022540047 200 g  
~~€ 20,10~~ € 15,70



## 2250-0

**Heavy duty swivel creeper seat with tray**

- Round swivel seat
- Height can be adjusted through a gas piston mechanism (410-530 mm)
- 5 pivoting castors

2 tote/tool trays, one being vertically adjustable

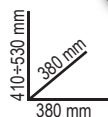

022500011 6 kg  
~~€ 72,50~~ € 56,70

## 1498PC

**Voltage stabilizer, 12-24 V**  
Protects control units in welding and starting processes

12-24 V



014980801 300 g  
~~€ 71,50~~ € 55,80

## 2251-0

**Heavy duty swivel creeper seat with drawers**

- Round swivel seat, height can be adjusted through a gas piston mechanism (430-560 mm)
- Square base (380x380 mm) with 2 drawers on one side and 1 drawer on the other
- 4 pivoting castors
- Weight: 11.5 kg



**New item**



410 ÷ 530 mm

380 mm

022510011 11,5 kg  
~~€ 129,00~~ € 100,70

## 2258-0

**Heavy duty creeper with tool chest**

- Overall height: 450 mm
- 3 drawers with ball bearing slides
- Front tote-tray
- Rear tote-tray with partitions
- 4 pivoting castors
- Weight: 10.2 kg



**New item**



450 mm

475 mm

355 mm

022580011 10,2 kg  
~~€ 129,50~~ € 101,20







## 3029/2T

Lowered hydraulic jack, 2 t, with 4 wheels

- Quick approach pedal
- Steel frame and nylon wheels
- Minimum height: 75 mm

**Min height: 75 mm**  
**Max height: 500 mm**

**New item**



**Maximum capacity: 2 tons**

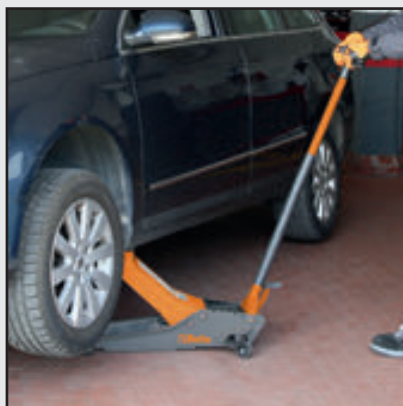

030290020 36 kg

€ 278,00 **€ 214,90**

## 3029L/2T

Long, lowered hydraulic jack, 2 t

- Makes it possible to work on vehicles with a reduced height from the ground and internal lifting point
- Controlled descent speed
- Quick approach pedal
- Nylon wheels

**Min height: 75 mm**  
**Max height: 530 mm**

**New item**

**Maximum capacity: 2 tons**

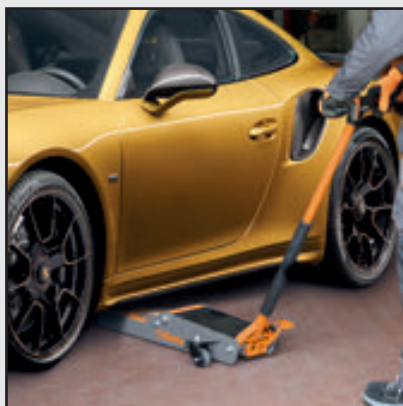

030290120 41 kg

€ 346,00 **€ 243,80**

## 3030/2T

Lowered hydraulic car jack, 2 t with 6 wheels

- Car jack can be easily handled on uneven, irregular floors
- Dual front tilting wheels made of plastic material (PTFE)
- Pedal allows easy approach

**Min height: 85 mm**  
**Max height: 520 mm**

**Maximum capacity: 2 tons**



030300020 45 kg

€ 559,00 **€ 439,40**

## 3025

**Folding hydraulic crane with dual effect pump**  
 Maximum capacity: 1 t  
 • Folding frame for significantly increased compactness  
 • 4 loading positions: 450-650-800-1000 kg  
 • Controlled descent speed

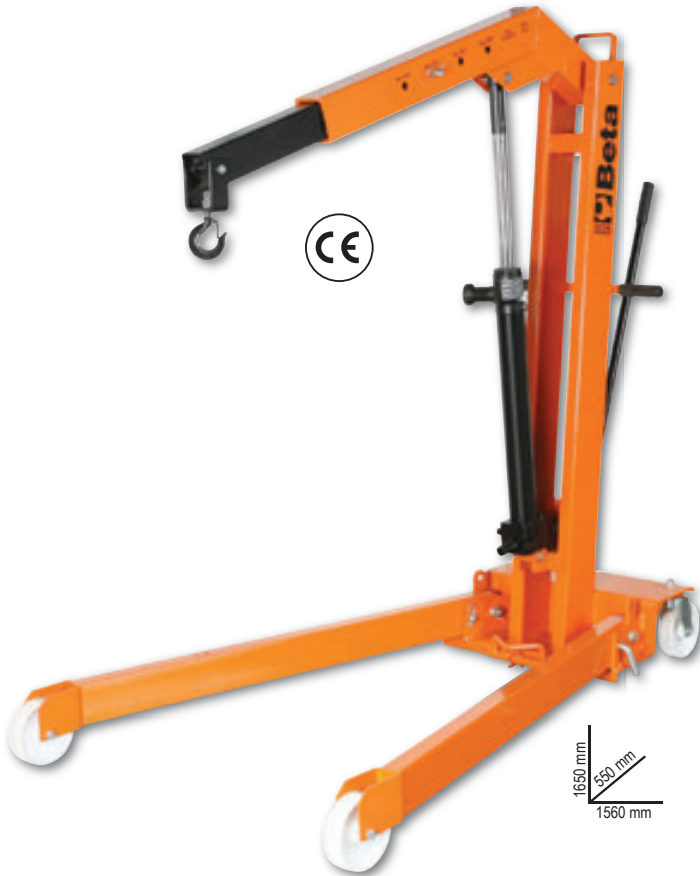

030250001 110 kg  
~~€ 1.400,00~~ € 1.149,00

## 3025/PF

**Barrel handling pliers**

**Maximum capacity: 300 kg**

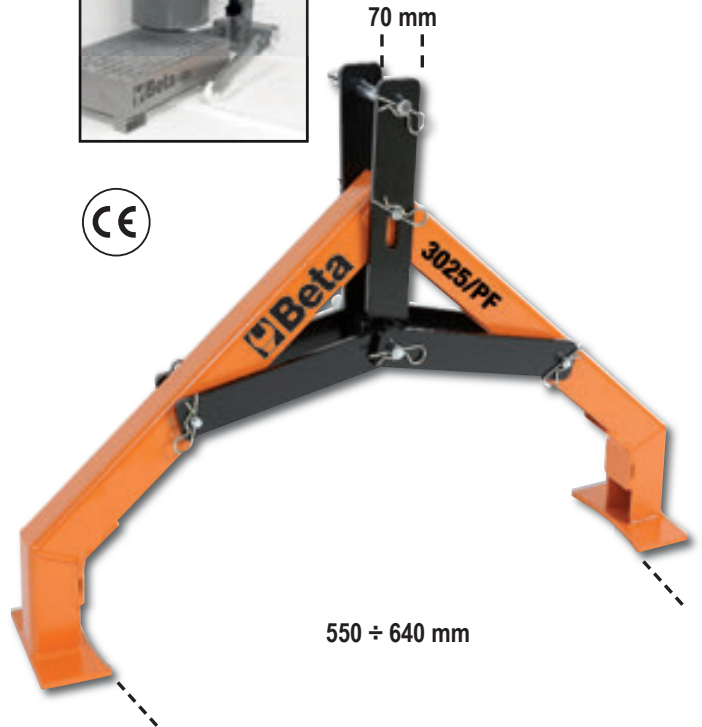

030250011 10 kg  
~~€ 211,50~~ € 169,40

## 3010T

**Jack stands, pair**

	Max kg	H min mm	H Max mm		<del>€</del>	€
3010/T2	2000	280	425	030100002	€ 72,00	€ 56,30
3010/T3	3000	285	430	030100003	€ 88,00	€ 68,80
3010/T6	6000	400	580	030100006	€ 130,00	€ 101,60
3010/T10	10000	471	735	030100010	€ 208,50	€ 163,10





**8143**

**Hand chain blocks**

- Professional model made of first-rate materials
- Automatic brake with double pawl system with double pawl system
- Swivel hook with safety latch

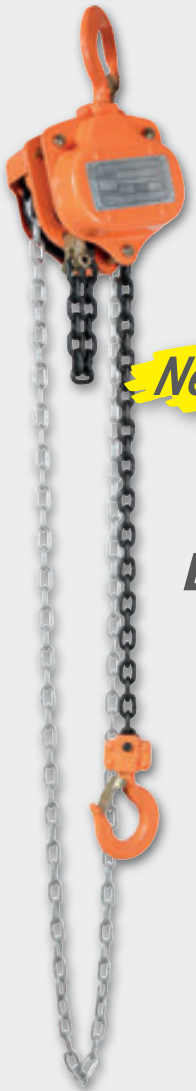

*New item*

**EN13157**

**8143 1 t**

WLL t	L m
1	3

081430010 12 kg

€ 126,00 € 97,20

**8143 2 t**

WLL t	L m
2	3

081430020 20 kg

€ 183,00 € 141,10

**8146C**

**Lever hoist, compact**

- Professional model easy to install and use
- Automatic brake with double pawl system for optimized safety
- Roller bearings for increased smoothness and durability
- Swivel hook with safety latch



*New item*

**EN13157**

**8146C 0,25 t**

WLL t	L m
0,25	1,5

081460002 2,5 kg

€ 120,50 € 93,00

**8146**

**Lever hoists**

- Professional model easy to install and use
- Automatic brake with double pawl system for optimized safety
- Roller bearings for increased smoothness and durability
- Swivel hook with safety latch

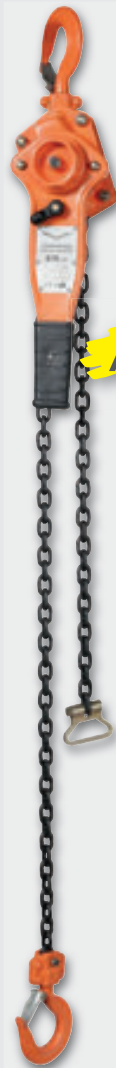

*New item*

**EN13157**

**8146 0,75 t**

WLL t	L m
0,75	1,5

081460008 7 kg

€ 123,00 € 95,10

**8146 1,5 t**

WLL t	L m
1,5	1,5

081460015 11 kg

€ 180,00 € 139,00



## 720/C24

Set of 24 impact sockets, 1/2" female drive, in metal case

Quantity/Description	Beta N.
15 10-12-13-14-15-16-17-18 19-21-22-24-27-30-32 mm	720
6 13-17-19-21-22-24 mm	720L
3 17-19-21 mm	720LC

007200904 1,7 kg

€ 234,00 € 180,80



12"

## 1924CD

Reversible impact wrench, made from composite material

- Double hammer impulse device
- Lightweight and well-balanced for enhanced ease of use
- High torque
- Reversible lever
- Three power adjustable screwing positions
- Exhaust through handle
- Silenced

Free speed	rpm	10.000
Max. torque	Nm	410
Bolt capacity	Cl 8.8	M16●24 mm
Bolt capacity	Cl 12.9	M14●21 mm
Air inlet	GAS	1/4"
Working pressure	bar	6,2
Internal hose size (Ø)	mm	8
Mean air consumption	l/min	79

019240007 1,3 kg

€ 209,50 € 164,70



3/8"

## 1924B

Compact reversible impact wrench

- "Pin Clutch" impulse device
- Lightweight and powerful
- Three power adjustable positions
- Exhaust through handle
- Balancing hook

Free speed	rpm	10.000
Max. torque	Nm	353
Bolt capacity	Cl 8.8	M16●24 mm
Bolt capacity	Cl 12.9	M14●21 mm
Air inlet	GAS	1/4"
Working pressure	bar	6,2
Internal hose size (Ø)	mm	8
Mean air consumption	l/min	80

019240021 1,5 kg

€ 168,50 € 132,60



3/8"



## 1927B

1/2"

### Reversible impact wrench

- "Pin Clutch" impulse device
- Rubber handle
- Reversible lever
- Three power adjustable screwing positions
- Exhaust through handle



Free speed	rpm	7.000
Impulse device		Pin Clutch
Max. torque	Nm	705
Bolt capacity	Cl 8.8	M22●34 mm
Bolt capacity	Cl 12.9	M18●27 mm
Air inlet	GAS	1/4"
Operating pressure	bar	6,2
Internal hose size (Ø)	mm	10
Mean air consumption	l/min	133

019270022 2,1 kg  
~~€ 123,00~~ € 96,00

## 1927G

1/2"

### Compact reversible impact wrench

- Single hammer impulse device
- Aluminium motor housing with composite handle
- One-handed reverse control
- Three power adjustable screwing positions
- Exhaust through handle
- Head motor with direct rotation transmission to output drive, resulting in improved body balancing and increased handiness



Free speed	rpm	8.500
Impulse device		Single hammer
Max. torque	Nm	325
Bolt capacity	Cl 8.8	M16●24 mm
Bolt capacity	Cl 12.9	M14●21 mm
Air inlet	GAS	1/4"
Operating pressure	bar	6,2
Internal hose size (Ø)	mm	10
Mean air consumption	l/min	113

019270050 1,2 kg  
~~€ 263,00~~ € 205,40

## 720ME/C8

1/2"

### 8 impact socket drivers for hexagon screws

- 5-6-8-10-12-14-17-19 mm



007200525 1,7 kg  
~~€ 99,00~~ € 76,30

270x120x45 mm

## 1927XM/K5

Assortment of 1 compact reversible impact wrench and 5 impact sockets, in plastic case

720 17-19-21-22-24 mm

019270129 2,8 kg

€ 229,50 € 170,00



307x206x86 mm

12"



## 1927CD

Reversible impact wrench

- Double hammer impulse device
- Lightweight and well-balanced for enhanced ease of use
- High torque
- Reversible lever
- Three power adjustable screwing positions
- Exhaust through handle
- Silenced

Free speed	rpm	7.000
Impulse device		Double hammer
Max. torque	Nm	1020
Bolt capacity	Cl 8.8	M22 ● 34 mm
Bolt capacity	Cl 12.9	M18 ● 27 mm
Air inlet	GAS	1/4"
Operating pressure	bar	6,2
Internal hose size (Ø)	mm	10
Mean air consumption	l/min	130

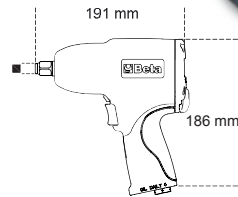

019270007 2,3 kg

€ 225,50 € 162,70

## 1927CD/K3

Assortment of 1 reversible impact wrench and 3 impact sockets

720LC 17-19-21 mm

019270107 4 kg

€ 275,00 € 215,20



350x305x86 mm

12"



## 1927P/K3

Reversible impact wrench, supplied with 3 impact sockets

**New item**

12"

019270118 3,5 kg

€ 304,00 € 238,90





# 1928XM

3/4"

## Compact reversible impact wrench

- double hammer impulse device
- amazingly compact and powerful
- one-hand reverse button
- three power adjustable screwing positions
- exhaust through handle

*New item*



**1.600 Nm**

Free speed	rpm	4.800
Impulse device		Double hammer
Max. torque	Nm	1600
Bolt capacity	Cl 8.8	M27●41 mm
Bolt capacity	Cl 12.9	M24●36 mm
Air inlet	GAS	3/8"
Operating pressure	bar	6,2
Internal hose size (Ø)	mm	10
Mean air consumption	l/min	175

*Ultra compact and powerful*

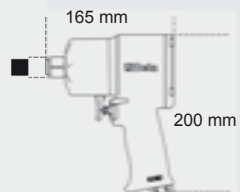

019280030 2,9 kg

€ 391,00 € 289,80



# 1928DA

3/4"

## Reversible impact wrench

- Double hammer impulse device
- Sturdy and compact; high torque
- Reversible lever
- Three power adjustable positions
- Exhaust through handle
- Slip-proof ergonomic handle



Free speed	rpm	5.000
Impulse device		Double hammer
Max. torque	Nm	1.695
Bolt capacity	Cl 8.8	M30●46 mm
Bolt capacity	Cl 12.9	M27●41 mm
Air inlet	GAS	3/8"
Operating pressure	bar	6,2
Internal hose size (Ø)	mm	10
Mean air consumption	l/min	210

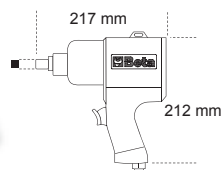

019280022 4,3 kg

€ 454,00 € 357,30



# 1928CD

3/4"

## Reversible impact wrench

- Double hammer impulse device
- High weight/power ratio
- Reversible lever
- Three power adjustable screwing positions
- Exhaust through handle
- Silenced



Free speed	rpm	4.500
Impulse device		Double hammer
Max. torque	Nm	1.800
Bolt capacity	Cl 8.8	M27●41 mm
Bolt capacity	Cl 12.9	M24●36 mm
Air inlet	GAS	3/8"
Operating pressure	bar	6,2
Internal hose size (Ø)	mm	10
Mean air consumption	l/min	215

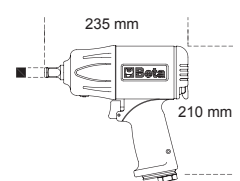

019280007 3,5 kg

€ 556,00 € 434,20



## 1930PA

### Reversible impact wrench

- Double hammer impulse device
- Auxiliary handle
- Reversible lever
- Three power adjustable screwing/unscrewing positions
- Exhaust through handle



Free speed	rpm	3.500
Impulse device		Double hammer
Max. torque	Nm	2445
Bolt capacity	Cl 8.8	M36 ● 55mm
Bolt capacity	Cl 12.9	M30 ● 46mm
Air inlet	GAS	1/2"
Operating pressure	bar	6,2
Internal hose size (Ø)	mm	13
Mean air consumption	l/min	350

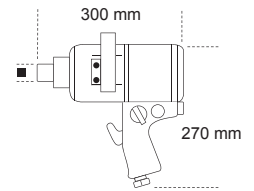

019300032

9,6 kg

€ 700,00

€ 547,50



## 1930LH

### Reversible impact wrench

- Double hammer impulse device
- 210 mm (8.3") long anvil
- New 70-degree angled handle design to relieve stress and fatigue on the operator's wrists
- Auxiliary side handle
- 3 power adjustable screwing/unscrewing positions
- Lower exhaust



Free speed	rpm	6.000
Impulse device		Double hammer
Max. torque	Nm	2.441
Bolt capacity	Cl 8.8	M36 ● 55 mm
Bolt capacity	Cl 12.9	M30 ● 46 mm
Air inlet	GAS	1/2"
Operating pressure	bar	6,2
Internal hose size (Ø)	mm	13
Mean air consumption	l/min	280

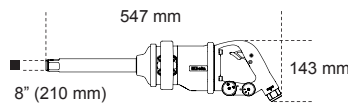

019300030

7,1 kg

€ 733,00

€ 576,50



## 1930LA

### Reversible impact wrench

- Double hammer impulse device
- 8" long anvil
- Auxiliary handle
- Reversible lever
- Three power adjustable screwing positions
- Lower exhaust



Free speed	rpm	4.000
Impulse device		Double hammer
Max. torque	Nm	2.445
Bolt capacity	Cl 8.8	M36 ● 55 mm
Bolt capacity	Cl 12.9	M30 ● 46 mm
Air inlet	GAS	1/2"
Operating pressure	bar	6,2
Internal hose size (Ø)	mm	13
Mean air consumption	l/min	460

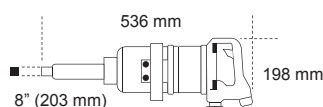

019300037

10,6 kg

€ 826,00

€ 620,50



# 1937

**Roto-orbital palm sander, lubrication free, made from composite material**

- No lubrication required
- Extremely compact and easy to handle
- 6-hole Velcro pad
- Continuous motor speed adjustment
- Nonslip, soft material handle
- Designed for connection to suction systems with swivel fittings
- Revolving exhaust



**Orbit diameter**  
2,5 mm  
5,0 mm

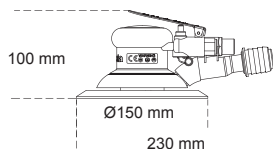

**Lubrication free**

	Ø Orbit mm	g			
<b>1937 2,5</b>	2,5	860	<b>019370000</b>	<del>€ 276,00</del>	<b>€ 215,80</b>
<b>1937</b>	5,0	860	<b>019370001</b>	<del>€ 293,00</del>	<b>€ 223,10</b>

Free speed	rpm	12.000
Power	kW	0,18
Pad size	mm	150
Spindle thread		5/16"-24
Air inlet	GAS	1/4"
Operating pressure	bar	6,2
Internal hose size (Ø)	mm	10
Mean air consumption	l/min	170

## Reversible air impact ratchets

- "Double rocking dog" impulse device
- Easy tightening: The impact mechanism system eliminates wrist twisting at end of screwing and shortens operating time
- Compact and powerful: maximum torque is significantly higher than maximum torque as achieved with a conventional ratchet
- Ergonomic rubber handle



**68 Nm**

164 mm

**1922P1** **14"**

019220006 0,6 kg

~~€ 167,50~~ **€ 132,00**

**1922P2** **38"**

019220010 0,6 kg

~~€ 167,50~~ **€ 132,00**

Free speed	rpm	700
Power	kW	<b>68</b>
Pad size	mm	M10●16 mm
Spindle thread		M8●13 mm
Air inlet	GAS	1/2"
Operating pressure	bar	6,2
Internal hose size (Ø)	mm	10
Mean air consumption	l/min	88

## High torque without affecting wrist

**136 Nm**



292 mm

**1922P3** **12"**

019220013 1,5 kg

~~€ 272,00~~ **€ 211,40**



Free speed	rpm	600
Power	kW	<b>136</b>
Pad size	mm	M12●18 mm
Spindle thread		M10●16 mm
Air inlet	GAS	1/2"
Operating pressure	bar	6,2
Internal hose size (Ø)	mm	10
Mean air consumption	l/min	113



## 1933IH

### High-power die grinder

- Collect chuck, Ø 3 mm and 6 mm

**New item**

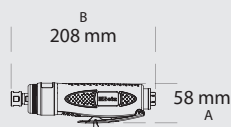

Free speed	rpm	20.000
Chuck capacity	mm	3-6
Power	kW	0,75
Air inlet	GAS	1/4"
Working pressure	bar	6,2
Internal hose size (Ø)	mm	10
Mean air consumption	l/min	370

019330006 800 g

€ 120,00 € 93,70

## 1933ILH

### High-power long spindle die grinder

- Collect chuck, Ø 3 mm and 6 mm

**New item**

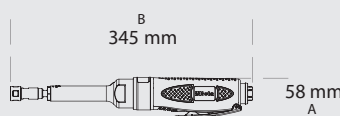

Free speed	rpm	20.000
Chuck capacity	mm	3-6
Power	kW	0,75
Air inlet	GAS	1/4"
Working pressure	bar	6,2
Internal hose size (Ø)	mm	10
Mean air consumption	l/min	370

019330011 1,2 kg

€ 227,00 € 177,50

## 1933AN90-H

### High-power angle grinder

- Collect chuck, Ø 3 mm and 6 mm

**New item**

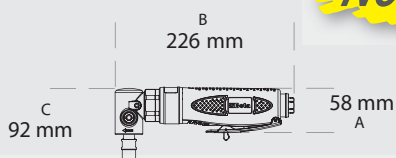

Free speed	rpm	15.000
Chuck capacity	mm	3-6
Power	kW	0,75
Air inlet	GAS	1/4"
Working pressure	bar	6,2
Internal hose size (Ø)	mm	10
Mean air consumption	l/min	370

019330021 1,1 kg

€ 227,00 € 177,50

## 1936/5A

### Angle grinder

- Extremely compact and handy
- Air governor for automatically controlling top speed
- Right-hand/left-hand auxiliary handle
- Spindle lock button
- Accessory for quickly changing discs
- Safety cap can be quickly adjusted in nine different positions through quick release
- Rear exhaust



Ø 125 mm

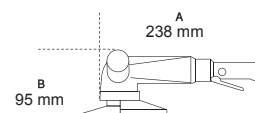

Free speed	rpm	10.000
Grinding disc size	mm	125
Power	kW	0,66
Spindle thread	M	14
Air inlet	GAS	1/4"
Working pressure	bar	6,2
Ø internal hose size	mm	10
Mean air consumption	l/min	390

019360025 1,9 kg

€ 239,00 € 186,80



## 1945C

### Stapler, nailer, combo tool

- Rubber coated handle
- Lightweight aluminium body
- Air exhaust can be rotated 360 degrees
- Safety device on tip
- Jam clearing mechanism
- Fields of use: building wood frames and packing cases, applying coatings and insulating materials, fixing skirting boards and glazing frames



Magazine capacity	pcs	100
Air inlet	GAS	1/4"
Working pressure	bar	5-8
Internal hose size (Ø)	mm	8
Air consumption (7 bar)	l/cycle	1,12

019450200 1,1 kg

€171,50 €134,10

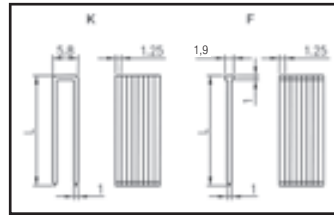

1945C/G

1945C/GP

## 1945C/G... *New item*

### Staples

Type 90, section 1.25x1.0 mm (18-Gauge), width 5.8 mm, for item 1945C

L mm	€	€	Item No.
16	€ 8,40	€ 6,80	019450216
19	€ 10,10	€ 8,20	019450219
22	€ 11,00	€ 8,90	019450222
25	€ 13,00	€ 10,50	019450225
28	€ 13,70	€ 11,10	019450228
32	€ 15,80	€ 12,80	019450232
35	€ 17,20	€ 14,00	019450235
38	€ 18,90	€ 15,30	019450238
40	€ 20,40	€ 16,60	019450240

Stated prices are for 5.000 pieces

## 1945C/GP... *New item*

### Nails

Type B12, section 1.25x1.0 mm (18-Gauge), 1.9 mm-head, for item 1945C

L mm	€	€	Item No.
15	€ 4,40	€ 3,60	019450255
16	€ 4,55	€ 3,70	019450256
20	€ 5,40	€ 4,40	019450260
25	€ 6,30	€ 5,10	019450265
30	€ 7,30	€ 5,90	019450270
32	€ 7,90	€ 6,40	019450272
35	€ 8,55	€ 6,90	019450275
38	€ 9,30	€ 7,50	019450278
40	€ 9,55	€ 7,80	019450280
45	€ 10,60	€ 8,60	019450285
50	€ 11,60	€ 9,40	019450290

Stated prices are for 5.000 pieces

## 1945S

### Stapler

- Rubber coated handle
- Lightweight aluminium body
- Air exhaust can be rotated 360 degrees
- Safety device on trigger
- Fields of use: footwear industry, building and finishing furniture, frames, building doors and windows, fair installations, sewing bags



Magazine capacity	pcs	157
Air inlet	GAS	1/4"
Working pressure	bar	4,2-7
Internal hose size (Ø)	mm	8
Air consumption (7 bar)	l/cycle	0,34

019450000 870 g

€119,00 €92,80

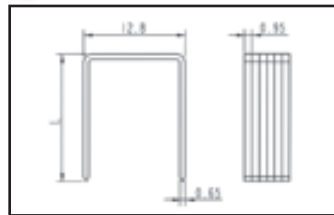

1945S/G

## 1945S/G... *New item*

### Staples

Type 80, section 0.95x0.65 mm (21-Gauge), width 12.8 mm, for item 1945S

L mm	€	€	Item No.
4	€ 11,00	€ 8,80	019450004
6	€ 4,20	€ 3,40	019450006
8	€ 4,70	€ 3,80	019450008
10	€ 5,20	€ 4,20	019450010
12	€ 5,85	€ 4,70	019450012
14	€ 6,35	€ 5,10	019450014
16	€ 7,00	€ 5,60	019450016

Stated prices are for 5.000 pieces  
• Stated prices are for 10.000 pieces

## 1945P

### Headless pinner

- Rubber coated handle
- Lightweight aluminium body
- Safety device on trigger
- Fields of use: concealing fixings, finishing furniture, making frames, fixing staff beads



Magazine capacity	pcs	145
Air inlet	GAS	1/4"
Working pressure	bar	4-7
Internal hose size (Ø)	mm	8
Air consumption (7 bar)	l/cycle	0,27

019450100 870 g

€185,00 €144,40

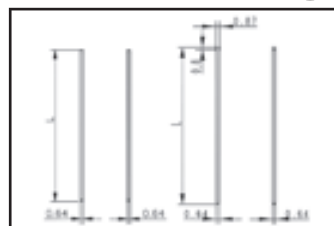

1945P/S

## 1945P/S... *New item*

### Pins

Type B6, Ø 0.64 mm (23-Gauge), for item 1945P

L mm	€	€	Item No.
12	€ 5,20	€ 4,20	019450112
15	€ 5,75	€ 4,60	019450115
18	€ 6,25	€ 5,00	019450118
20	€ 7,20	€ 5,80	019450120
21	€ 7,30	€ 5,90	019450121
22	€ 7,45	€ 6,00	019450122
25	€ 8,00	€ 6,40	019450125
30	€ 9,15	€ 7,30	019450130
35	€ 10,60	€ 8,50	019450135

Stated prices are for 10.000 pieces

# 1951A

*New item*

## Suction cleaning gun

- For cleaning car upholstery, carpeting, seats and boots
- For use with suitable detergents
- 1L tank
- Fitted with a tap for dispensing liquid from tank
- Complete with corrugated tube, 1.8 m long



Tank capacity	liters	1
Air inlet	GAS	1/4"
Working pressure	bar	6,2
Internal hose size (Ø)	mm	8
Air consumption	l/min	120

019510101 800 g  
 €143,50 € 110,80

# 1946C4,8

## Automatic air suction riveter

- Professional air riveter for use with 2.4 - 3.2 - 4.0 - 4.8 mm long steel, stainless steel, aluminium and copper rivets
- Pointed cone-shaped spout
- Powerful and handy, with handle made of composite material
- Complete with safety nail container and oil gun



Material/Riveter	2,4	3,2	4	4,8
copper	✓	✓	✓	✓
aluminium	✓	✓	✓	✓
steel	✓	✓	✓	✓
stainless steel	✓	✓	✓	✓

Traction power	N	8.900
Stroke length	mm	15
Maximum rivet capacity	Ø stainless steel	4,8 mm
Air inlet	GAS	1/4"
Working pressure	bar	6,2
Internal hose size (Ø)	mm	10
Air consumption	l/cycle	2,6

019460006 1,5 kg  
 €437,00 € 336,90

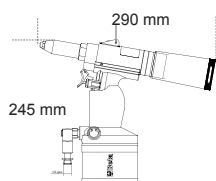

# 1942A

## Air saw

- Powerful and handy
- Designed for cutting bodies, exhaust pipes and silencers, aluminium and plastic
- Complete with rubber handle, PVC exhaust pipe and air-feeding hose
- Rear exhaust

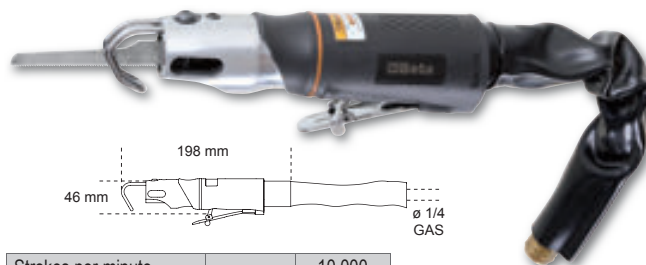

Strokes per minute		10.000
Stroke length	mm	10
Air inlet	GAS	1/4"
Operating pressure	bar	6,2
Internal hose size (Ø)	mm	8
Mean air consumption	l/min	75



019420000 550 g  
 €194,00 € 151,80

## Automatic hose reels

- Shock-proof plastic body for compressed air or cold water
- Metal clamp, revolving
- Device for automatically fixing hose at desired length

### 1901BM/8 1901T/10

Air inlet	GAS	1/4"	3/8"
Hose length	m	94	154
Max. operating pressure	bar	12	15
Internal hose size Ø	mm	8	10
Tube material		Polyurethane	Polyurethane

# 1901BM/8

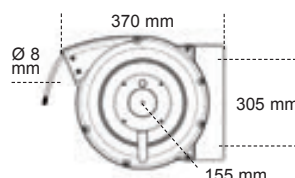

019010111 3,5 kg  
 €189,00 € 144,00



# 1901T/10

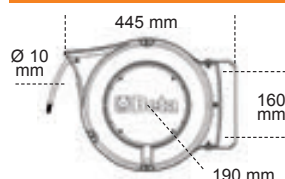

019010210 6,5 kg  
 €226,00 € 176,40





## 1952

*New item*

### Professional paint spray gun

- Die-cast aluminium body plated with black chemical nickel
- Nylon cup with drip-catching device, 3/8M BSP thread
- Body thread: 1/4" BSP cylindrical gas thread
- Pressure and airflow regulator
- Jet regulator from round to fan spray pattern
- Paint quantity regulator
- Supplied with service spanner for maintenance operations



jet Ø				
1952 1,2	019520012	€ 101,50	€ 78,30	
1952 1,5	019520015	€ 101,50	€ 78,30	
1952 1,8	019520018	€ 101,50	€ 78,30	
1952 2,0	019520020	€ 101,50	€ 78,30	

## 1949DGT

### Digital tyre inflator

- Operating pressure: 0÷11 bar (2.0÷160 psi)
- 4 units of measurement: psi/bar/kgcm<sup>2</sup>/kpa
- Backlit LCD display
- Reset feature
- Self-power off after 3 min.
- Pressure release button
- Resolution: 0.05 bars
- ABS housing, protective rubber shell on gauge, shockproof, nonslip handle grip
- Power supply: 2 AAA size 1.5V batteries
- Compatible with coupling 1916G 1/4"



019490020	500 g	€ 113,50	€ 88,90
-----------	-------	----------	---------

## 1949U5

*New item*

### Progressive blow gun with 5 nozzles

- Hard-wearing, shockproof composite material body
- 3 steel nozzles, 100/160/320 mm, scratchproof, protective rubber tips
- 1 "Turbo" nozzle made of fibreglass-reinforced nylon with safety tip
- 1 revolving nozzle, 100 mm, made of fibreglass-reinforced nylon
- With quick fixing system



019490030 230 g

€ 23,80 € 18,60

How many steps do you walk in a day?  
And in a year?

**New item**

# “0-Gravity” range

100 grams less for each step walked mean saving approximately  
1000 kilos a day and over **200 tons a year!**

<sup>1</sup>compared to the average weight of a shoe of the same category, size 42

- EVA outsole with durable nitrile rubber tread
- Stretch slip-on collar
- Heel stability support

**WALK  
LIGHTER!**

**420 g**

(approximate weight, size 42)



EU	UK	SKU
38	5	073530038
39	6	073530039
40	6,5	073530040
41	7	073530041
42	8	073530042
43	9	073530043
44	10	073530044
45	10,5	073530045
46	11	073530046
47	12	073530047
48	13	073530048

## 7353Y

Mesh fabric shoe, highly breathable, with TPU inserts  
High-visibility reflective mesh upper

- Carbon fibre toe cap
- Composite fibre penetration-proof insole



EN ISO  
20345  
2011

~~€ 99,00~~ € 79,50

S1P HRO SRC



# "0-Gravity" range



## 7352A

**New item**

Mesh fabric shoe,  
highly breathable,  
with TPU inserts

- Composite toe cap
- Composite fibre penetration-proof insole

EU	UK	Product Code
38	5	073520038
39	6	073520039
40	6,5	073520040
41	7	073520041
42	8	073520042
43	9	073520043
44	10	073520044
45	10,5	073520045
46	11	073520046
47	12	073520047
48	13	073520048

450 g



EN ISO  
20345  
2011

€73,00 € 58,40

S1P HRO SRC

## 7352B

**New item**

Mesh fabric shoe,  
highly breathable,  
with TPU inserts

- Composite toe cap
- Composite fibre penetration-proof insole

EU	UK	Product Code
38	5	073520138
39	6	073520139
40	6,5	073520140
41	7	073520141
42	8	073520142
43	9	073520143
44	10	073520144
45	10,5	073520145
46	11	073520146
47	12	073520147
48	13	073520148

450 g



EN ISO  
20345  
2011

€73,00 € 58,40

S1P HRO SRC

## 7354N

**New item**

Mesh fabric shoe,  
waterproof,  
with TPU inserts

- Composite toe cap
- Composite fibre penetration-proof insole

EU	UK	Product Code
38	5	073540038
39	6	073540039
40	6,5	073540040
41	7	073540041
42	8	073540042
43	9	073540043
44	10	073540044
45	10,5	073540045
46	11	073540046
47	12	073540047
48	13	073540048

460 g



EN ISO  
20345  
2011

€77,50 € 63,10

S3 HRO SRC

## 7355V

**New item**

Mesh fabric ankle shoe,  
waterproof,  
with TPU inserts

- Composite toe cap
- Composite fibre penetration-proof insole

EU	UK	Product Code
38	5	073550038
39	6	073550039
40	6,5	073550040
41	7	073550041
42	8	073550042
43	9	073550043
44	10	073550044
45	10,5	073550045
46	11	073550046
47	12	073550047
48	13	073550048

465 g



EN ISO  
20345  
2011

€82,50 € 66,80

S3 HRO SRC



## “BASIC” line

With composite fibre penetration-proof insoles:  
**INCREASED FLEXIBILITY = INCREASED COMFORT**

### 7241CK

Leather shoe,  
water-repellent

- Steel toe cap
- Composite fibre penetration proof insole

EU	UK	Product Code
35	2,5	072411535
36	3,5	072411536
37	4,5	072411537
38	5	072411538
39	6	072411539
40	6,5	072411540
41	7	072411541
42	8	072411542
43	9	072411543
44	10	072411544
45	10,5	072411545
46	11	072411546
47	12	072411547
48	13	072411548



EN ISO  
20345  
2011

S3 SRC

€ 32,00 € 25,60

### 7243CK

Leather ankle shoe,  
water-repellent,  
with quick opening system

- Steel toe cap
- Composite fibre penetration proof insole

EU	UK	Product Code
35	2,5	072431335
36	3,5	072431336
37	4,5	072431337
38	5	072431338
39	6	072431339
40	6,5	072431340
41	7	072431341
42	8	072431342
43	9	072431343
44	10	072431344
45	10,5	072431345
46	11	072431346
47	12	072431347
48	13	072431348



EN ISO  
20345  
2011

S3 RS SRC

€ 32,50 € 26,30

QUICK OPENING  
SYSTEM

### 7245BK

Lace-up leather ankle shoe,  
“welder style”, water-repellent,  
with quick opening system  
and front protection  
with strap closure

- Steel toe cap
- Composite fibre penetration proof insole

EU	UK	Product Code
35	2,5	072451235
36	3,5	072451236
37	4,5	072451237
38	5	072451238
39	6	072451239
40	6,5	072451240
41	7	072451241
42	8	072451242
43	9	072451243
44	10	072451244
45	10,5	072451245
46	11	072451246
47	12	072451247
48	13	072451248



EN ISO  
20345  
2011

S3 RS SRC

€ 35,50 € 28,60

QUICK OPENING  
SYSTEM

### 7246BK

Suede shoe, perforated

- Steel toe cap
- Composite fibre penetration proof insole

EU	UK	Product Code
35	2,5	072461235
36	3,5	072461236
37	4,5	072461237
38	5	072461238
39	6	072461239
40	6,5	072461240
41	7	072461241
42	8	072461242
43	9	072461243
44	10	072461244
45	10,5	072461245
46	11	072461246
47	12	072461247
48	13	072461248



EN ISO  
20345  
2011

S1P SRC

€ 32,00 € 25,60



## 7223PEK

Suede shoe with highly breathable mesh inserts and anti-abrasion reinforcement in toe cap area

- Composite toe cap
- Composite fibre penetration proof insole



~~€ 42,50~~ € 34,20

EU	UK	
35	2,5	072230135
36	3,5	072230136
37	4,5	072230137
38	5	072230138
39	6	072230139
40	6,5	072230140
41	7	072230141
42	8	072230142
43	9	072230143
44	10	072230144
45	10,5	072230145
46	11	072230146
47	12	072230147
48	13	072230148

EN ISO 20345 2011

S1P SRC

## 7224PEK

Suede shoe, perforated, with anti-abrasion reinforcement in toe cap area

- Composite toe cap
- Composite fibre penetration proof insole



~~€ 42,50~~ € 34,20

EU	UK	
35	2,5	072240235
36	3,5	072240236
37	4,5	072240237
38	5	072240238
39	6	072240239
40	6,5	072240240
41	7	072240241
42	8	072240242
43	9	072240243
44	10	072240244
45	10,5	072240245
46	11	072240246
47	12	072240247
48	13	072240248

EN ISO 20345 2011

S1P SRC

## 7236BK

Action Nubuck ankle shoe, waterproof, with quick opening system and reinforcement polyurethane toe cap cover

- Steel toe cap
- Composite fibre penetration proof insole



~~€ 47,00~~ € 38,00

EU	UK	
35	2,5	072360335
36	3,5	072360336
37	4,5	072360337
38	5	072360338
39	6	072360339
40	6,5	072360340
41	7	072360341
42	8	072360342
43	9	072360343
44	10	072360344
45	10,5	072360345
46	11	072360346
47	12	072360347
48	13	072360348

EN ISO 20345 2011

S3 RS SRC



## 7218FN

Action nubuck ankle shoe, water-repellent, with anti-abrasion insert in toe cap area and quick opening system

- Composite toe cap
- Composite fibre penetration-proof insole



**QUICK OPENING SYSTEM**

EU	UK	Icon
35	2,5	072180035
36	3,5	072180036
37	4,5	072180037
38	5	072180038
39	6	072180039
40	6,5	072180040
41	7	072180041
42	8	072180042
43	9	072180043
44	10	072180044
45	10,5	072180045
46	11	072180046
47	12	072180047
48	13	072180048

**EN ISO 20345 2011**

**S3 RS SRC**

~~€ 52,50~~ € 41,00

## 7290NA

Full-grain leather, shoe, waterproof, with reinforcement polyurethane toe cap cover and PUT/PTU VIBRAM® outsole.

- Composite toe cap
- Composite fibre penetration proof insole



EU	UK	Icon
36	3,5	072900336
37	4,5	072900337
38	5	072900338
39	6	072900339
40	6,5	072900340
41	7	072900341
42	8	072900342
43	9	072900343
44	10	072900344
45	10,5	072900345
46	11	072900346
47	12	072900347
48	13	072900348

**EN ISO 20345 2011**

**S3 SRC ESD**

~~€ 119,00~~ € 91,20

## 7291NA

Full-grain leather ankle shoe, waterproof, with reinforcement polyurethane toe cap cover and PU/PTU VIBRAM® outsole.

- Composite toe cap
- Composite fibre penetration proof insole



EU	UK	Icon
36	3,5	072910336
37	4,5	072910337
38	5	072910338
39	6	072910339
40	6,5	072910340
41	7	072910341
42	8	072910342
43	9	072910343
44	10	072910344
45	10,5	072910345
46	11	072910346
47	12	072910347
48	13	072910348

**EN ISO 20345 2011**

**S3 SRC ESD**

~~€ 123,00~~ € 95,90





# HEAVYDUTY

THE BEST PERFORMANCE 100% MADE IN ITALY



- **Upper:** Greased full-grain leather, waterproof, with reinforcement polyurethane toe cap cover and anti-abrasion insert on heel area
- **Toe Cap:** Fibreglass, 200 joules
- **Penetration-proof insole:** Composite fibre, ceramic treatment.
- **WIDE BODY**



- VIBRAM® "Ranger" rubber tread, heat resistant outsole (HRO), designed to provide unparalleled performance
- Polyurethane foam midsole of low specific weight
- Polyurethane reinforced cover



- Black fabric bound to PE and EVA, a material which does not get deformed and regains its initial shape when the foot is taken out of the shoe. Perforated sole to offer better breathability and ABS heel insert varying in density for improved shock absorption with the ground

## 7293HM



EU	UK	Product Code
39	6	072930639
40	6,5	072930640
41	7	072930641
42	8	072930642
43	9	072930643
44	10	072930644
45	10,5	072930645
46	11	072930646
47	12	072930647
48	13	072930648



EN ISO 20345 2011

€ 114,00 € 92,60

S3 HRO HI SRC

## 7294HM



EU	UK	Product Code
39	6	072940639
40	6,5	072940640
41	7	072940641
42	8	072940642
43	9	072940643
44	10	072940644
45	10,5	072940645
46	11	072940646
47	12	072940647
48	13	072940648



EN ISO 20345 2011

€ 121,00 € 98,50

S3 HRO HI SRC

## 7293HN

Nubuck shoe, waterproof, with SUPPORT SYSTEM for lateral ankle support

- Steel toe cap
- Composite fibre penetration proof insole

EU	UK	Product Code
39	6	072930839
40	6,5	072930840
41	7	072930841
42	8	072930842
43	9	072930843
44	10	072930844
45	10,5	072930845
46	11	072930846
47	12	072930847



EN ISO 20345 2011

€ 95,50 € 83,20

S3 HRO HI SRC

## 7294HN

Nubuck ankle shoe, waterproof, with SUPPORT SYSTEM for lateral ankle support and quick opening system

- Steel toe cap
- Composite fibre penetration proof insole

EU	UK	Product Code
39	6	072940839
40	6,5	072940840
41	7	072940841
42	8	072940842
43	9	072940843
44	10	072940844
45	10,5	072940845
46	11	072940846
47	12	072940847

QUICK OPENING SYSTEM



EN ISO 20345 2011

€ 99,00 € 86,50

S3 HRO HI SRC

# "ACTIVE" line



## 7314AF

Suede shoe with nylon mesh and carbon inserts

- Composite toe cap
- Composite fibre penetration proof insole

EU	UK	Code
35	2,5	073140235
36	3,5	073140236
37	4,5	073140237
38	5	073140238
39	6	073140239
40	6,5	073140240
41	7	073140241
42	8	073140242
43	9	073140243
44	10	073140244
45	10,5	073140245
46	11	073140246
47	12	073140247
48	13	073140248



EN ISO 20345 2011

S1P SRC

~~€ 65,00~~ € 56,00

## 7314AB

Suede shoe with nylon mesh and carbon inserts

- Composite toe cap
- Composite fibre penetration proof insole

EU	UK	Code
35	2,5	073140335
36	3,5	073140336
37	4,5	073140337
38	5	073140338
39	6	073140339
40	6,5	073140340
41	7	073140341
42	8	073140342
43	9	073140343
44	10	073140344
45	10,5	073140345
46	11	073140346
47	12	073140347
48	13	073140348



EN ISO 20345 2011

S1P SRC

~~€ 65,00~~ € 56,00

## 7315AN

Suede and microfibre shoe, water-repellent, with carbon inserts

- Composite toe cap
- Composite fibre penetration proof insole

EU	UK	Code
35	2,5	073150535
36	3,5	073150536
37	4,5	073150537
38	5	073150538
39	6	073150539
40	6,5	073150540
41	7	073150541
42	8	073150542
43	9	073150543
44	10	073150544
45	10,5	073150545
46	11	073150546
47	12	073150547
48	13	073150548



EN ISO 20345 2011

S3 SRC

~~€ 75,50~~ € 64,00

## 7318AN

Suede and microfibre ankle shoe, water-repellent, with carbon inserts

- Composite toe cap
- Composite fibre penetration proof insole

EU	UK	Code
35	2,5	073180535
36	3,5	073180536
37	4,5	073180537
38	5	073180538
39	6	073180539
40	6,5	073180540
41	7	073180541
42	8	073180542
43	9	073180543
44	10	073180544
45	10,5	073180545
46	11	073180546
47	12	073180547
48	13	073180548



EN ISO 20345 2011

S3 SRC

~~€ 77,00~~ € 65,40



# "FIT PRO" line

## 7340B

Mesh fabric shoe, highly breathable, with high-frequency PU inserts and protective toe cap reinforcement made of crust suede

- Aluminium toe cap
- Composite fibre penetration-proof insole
- FixLock closing makes it easier to put and remove the shoe (traditional laces included)

EU	UK	SKU
36	3,5	073400236
37	4,5	073400237
38	5	073400238
39	6	073400239
40	6,5	073400240
41	7	073400241
42	8	073400242
43	9	073400243
44	10	073400244
45	10,5	073400245
46	11	073400246
47	12	073400247

FIT PRO NET



EN ISO 20345 2011  
S1P SRC

€ 103,00 € 79,50

## 7340R

Mesh fabric shoe, highly breathable, with high-frequency PU inserts and protective toe cap reinforcement made of crust suede

- Aluminium toe cap
- Composite fibre penetration-proof insole
- FixLock closing makes it easier to put and remove the shoe (traditional laces included)

EU	UK	SKU
36	3,5	073400436
37	4,5	073400437
38	5	073400438
39	6	073400439
40	6,5	073400440
41	7	073400441
42	8	073400442
43	9	073400443
44	10	073400444
45	10,5	073400445
46	11	073400446
47	12	073400447

FIT PRO NET



EN ISO 20345 2011  
S1P SRC

€ 103,00 € 79,50

## 7341N

Microsuede shoe, waterproof, with high-frequency PU inserts and protective toe cap reinforcement made of crust suede

- Aluminium toe cap
- Composite fibre penetration-proof insole
- FixLock closing makes it easier to put and remove the shoe (traditional laces included)

EU	UK	SKU
36	3,5	073410236
37	4,5	073410237
38	5	073410238
39	6	073410239
40	6,5	073410240
41	7	073410241
42	8	073410242
43	9	073410243
44	10	073410244
45	10,5	073410245
46	11	073410246
47	12	073410247



FIT PRO

EN ISO 20345 2011  
S3 SRC

€ 108,00 € 83,20



## 7546BL

### Three-button polo shirt

- Pique cotton, 220 g/m<sup>2</sup>
- Reinforced placket and hidden buttons



XS	075460000
S	075460001
M	075460002
L	075460003
XL	075460004
XXL	075460005
XXXL	075460006



~~€ 25,50~~ € 20,90

## 7546G

### Three-button polo shirt

- Pique cotton, 220 g/m<sup>2</sup>
- Reinforced placket and hidden buttons



XS	075460100
S	075460101
M	075460102
L	075460103
XL	075460104
XXL	075460105
XXXL	075460106



~~€ 25,50~~ € 20,90

## 7546N

### Three-button polo shirt

- Pique cotton, 220 g/m<sup>2</sup>
- Reinforced placket and hidden buttons



XS	075460200
S	075460201
M	075460202
L	075460203
XL	075460204
XXL	075460205
XXXL	075460206



~~€ 25,50~~ € 20,90

## 7548BL

### Work t-shirt

- 100% jersey cotton, 180 g/m<sup>2</sup>
- Small rear logo



XS	075480000
S	075480001
M	075480002
L	075480003
XL	075480004
XXL	075480005
XXXL	075480006



~~€ 13,50~~ € 9,30

## 7548G

### Work t-shirt

- 100% jersey cotton, 180 g/m<sup>2</sup>
- Small rear logo



XS	075480100
S	075480101
M	075480102
L	075480103
XL	075480104
XXL	075480105
XXXL	075480106



~~€ 13,50~~ € 9,30

## 7548N

### Work t-shirt

- 100% jersey cotton, 180 g/m<sup>2</sup>
- Small rear logo



XS	075480200
S	075480201
M	075480202
L	075480203
XL	075480204
XXL	075480205
XXXL	075480206



~~€ 13,50~~ € 9,30



## 7579T

### Sleeveless work jacket, multipocket style

- 100% 300D nylon, waterproof, durable
- 95% polyester-5% stretch fabric, waterproof
- 100% polyester
- polyester 140 g/m<sup>2</sup>



M	075790002
L	075790003
XL	075790004
XXL	075790005
XXXL	075790006

~~€ 41,50~~ € 36,30

## 7634G

### Technical sweatshirt, long-zipped

- 67% polyester, 28% rayon, 5% spandex, 325 g
- 3D fabric for improved breathability and freedom of movement



XS	076340100
S	076340101
M	076340102
L	076340103
XL	076340104
XXL	076340105
XXXL	076340106

~~€ 54,00~~ € 47,80

## 7636BL

### Microfleece sweater, long-zipped

- 100% polyester, 180 g/m<sup>2</sup>
- Two waist pockets with zip closure
- Stretch wrist and waist tape
- Cuffs with thumb holes



XS	076360000
S	076360001
M	076360002
L	076360003
XL	076360004
XXL	076360005
XXXL	076360006

~~€ 20,90~~ € 17,70

## 7684

### Softshell jacket

- 94% polyester, 6% spandex, 290 g/m<sup>2</sup>
- 100% microfleece polyester



S	076840001
M	076840002
L	076840003
XL	076840004
XXL	076840005
XXXL	076840006

~~€ 78,00~~ € 55,30

## 7734

### Triple use Anorak jacket, waterproof

- Outer Anorak jacket
- Oxford polyester 300D, waterproof, with polyester 600D inserts, both PU-coated (resistance to water columns up to 2,000 mm).
- Polyester 210T lining, polyester padding, 80 g/m<sup>2</sup>



S	077340001
M	077340002
L	077340003
XL	077340004
XXL	077340005
XXXL	077340006

~~€ 131,50~~ € 100,60

## 7980R

### Cuffed winter cap

- 100% acrylic
- 3M Thinsulate™ padding



079800111

~~€ 5,90~~ € 5,20

## 7051MP

Eye protector with polycarbonate visor



070510001

~~€ 5,15~~ € 3,60

## 7076BP

Safety glasses with polarized polycarbonate lenses



070760029

~~€ 16,70~~ € 11,50

## 7810

**New item**

“Work trekking” trousers, multipocket style

- 90% nylon, 10% stretch fabric, 265 g
- Stretch waistband
- Bi-stretchable fabric for improved comfort
- Stretch leg bottom with vertical zip closure



S	078100101
M	078100102
L	078100103
XL	078100104
XXL	078100105

~~€ 53,00~~ € 46,30

## 7811

**SLIM FIT**

“Work trekking” trousers

- 90% nylon, 10% stretch fabric, 265 g
- Stretch waistband
- Bi-stretchable fabric for improved comfort
- Stretch leg bottom with vertical zip closure



S	078110001
M	078110002
L	078110003
XL	078110004
XXL	078110005

~~€ 51,50~~ € 40,30

## 7816BL

Work trousers, multipocket style

- T/C canvas, 65% polyester, 35% cotton, 260 g/m<sup>2</sup>
- Knee pad pockets and leg bottoms reinforced in polyester 600D



XS	078160100
S	078160101
M	078160102
L	078160103
XL	078160104
XXL	078160105
XXXL	078160106

~~€ 50,00~~ € 38,20

## 7820

Work trousers, multipocket style

- Twisted T/C canvas, 65% polyester, 35% cotton, 280 g/m<sup>2</sup>
- Cordura® Fabric knee reinforcements
- 3M Scotchlite™ Reflective Material inserts
- Central YKK® zip



XS	078200000
S	078200001
M	078200002
L	078200003
XL	078200004
XXL	078200005
XXXL	078200006
XXXXL	078200007

~~€ 63,00~~ € 45,70





## 7821

### Work Bermuda shorts, multipocket style

- Twisted T/C canvas, 65% polyester, 35% cotton, 280 g/m<sup>2</sup>

XS	078210000
S	078210001
M	078210002
L	078210003
XL	078210004
XXL	078210005
XXXL	078210006
XXXXL	078210007



~~€ 46,50~~ € 39,60

## 7970

### Trousers, waterproof

- PVC Tricot

XS	079700000
S	079700001
M	079700002
L	079700003
XL	079700004
XXL	079700005
XXXL	079700006



~~€ 24,50~~ € 18,50

## 7980N

### Rainproof cap



L Ø58cm	079800058
XL Ø60cm	079800060

~~€ 7,05~~ € 6,30

## 7823

### Work overalls, multipocket style

- Twisted T/C canvas, 65% polyester, 35% cotton, 280 g/m<sup>2</sup>
- Cordura® Fabric knee reinforcements
- 3M Scotchlite™ Reflective Material inserts
- Central YKK® zip

XS	078230000
S	078230001
M	078230002
L	078230003
XL	078230004
XXL	078230005
XXXL	078230006
XXXXL	078230007



~~€ 75,50~~ € 57,40

## 7825

### Work overalls, multipocket style

- Twisted T/C canvas, 65% polyester, 35% cotton, 280 g/m<sup>2</sup>
- Cordura® Fabric knee reinforcements
- 3M Scotchlite™ Reflective Material inserts
- Front closure with YKK® double tab zip, covered with a strap flap
- Elastic waistband
- Cuffs with PVC strap adjusters

XS	078250000
S	078250001
M	078250002
L	078250003
XL	078250004
XXL	078250005
XXXL	078250006
XXXXL	078250007



~~€ 99,00~~ € 75,00

## 7829

### Work jacket

- Twisted T/C canvas, 65% polyester, 35% cotton, 280 g/m<sup>2</sup>
- Cordura® Fabric elbow reinforcements
- 3M Scotchlite™ Reflective Material inserts
- Front closure with YKK® double tab zip, covered with a strap flap
- Cuffs with PVC strap adjusters



XS	078290000
S	078290001
M	078290002
L	078290003
XL	078290004
XXL	078290005
XXXL	078290006
XXXXL	078290007



~~€ 69,00~~ € 49,70

## 7979

### Jacket, waterproof

- PVC Tricot
- Foldaway hood
- Cuffs with strap adjusters
- Two deep front pockets



S	079790001
M	079790002
L	079790003
XL	079790004
XXL	079790005
XXXL	079790006



~~€ 41,00~~ € 30,20

## 7900E

### Work trousers, multipocket style

- T/C canvas, 65% polyester, 35% cotton, 260 g
- Hammer loop
- Triple stitching in points more subject to wear
- Metal zip closure
- Ruler pocket and hammer loop



XS	079000900
S	079000901
M	079000902
L	079000903
XL	079000904
XXL	079000905
XXXL	079000906
XXXXL	079000907

~~€ 36,00~~ € 22,30

## 7903E

### Work overalls

- T/C canvas, 65% polyester, 35% cotton, 260 g



XS	079030900
S	079030901
M	079030902
L	079030903
XL	079030904
XXL	079030905
XXXL	079030906
XXXXL	079030907

~~€ 45,00~~ € 27,90

## 7904E

### Work bomber jacket, padded, lined

- T/C canvas, 65% polyester, 35% cotton, 260 g/m<sup>2</sup>



XS	079040900
S	079040901
M	079040902
L	079040903
XL	079040904
XXL	079040905
XXXL	079040906
XXXXL	079040907



~~€ 71,50~~ € 44,30

## 7905E

### Work overalls

- T/C canvas, 65% polyester, 35% cotton, 260 g



XS	079050900
S	079050901
M	079050902
L	079050903
XL	079050904
XXL	079050905
XXXL	079050906
XXXXL	079050907

~~€ 58,00~~ € 36,30

## 7909E

### Work jacket

- T/C canvas, 65% polyester, 35% cotton, 260 g/m<sup>2</sup>



XS	079090900
S	079090901
M	079090902
L	079090903
XL	079090904
XXL	079090905
XXXL	079090906
XXXXL	079090907

~~€ 40,50~~ € 24,60

## 7901E

### Work short

- T/C canvas, 65% polyester, 35% cotton, 260 g/m<sup>2</sup>



XS	079010900
S	079010901
M	079010902
L	079010903
XL	079010904
XXL	079010905
XXXL	079010906
XXXXL	079010907

~~€ 30,00~~ € 18,50

## 7907E

### Sleeveless work jacket, multipocket style

- T/C canvas, 65% polyester, 35% cotton, 260 g/m<sup>2</sup>



XS	079070900
S	079070901
M	079070902
L	079070903
XL	079070904
XXL	079070905
XXXL	079070906
XXXXL	079070907

~~€ 34,00~~ € 20,90





## 7930G

### Work trousers

- 100% stretch cotton, 220 g
- Slim fit

**New item**



XS	079300300
S	079300301
M	079300302
L	079300303
XL	079300304
XXL	079300305
XXXL	079300306

~~€ 37,00~~ € 30,20

## 7933G

### Work overalls

- 100% stretch cotton, 220 g
- Slim fit

**New item**



XS	079330300
S	079330301
M	079330302
L	079330303
XL	079330304
XXL	079330305
XXXL	079330306

~~€ 47,50~~ € 38,70

## 7935G

### Work overalls

- 100% stretch cotton, 220 g
- Slim fit

**New item**



XS	079350300
S	079350301
M	079350302
L	079350303
XL	079350304
XXL	079350305
XXXL	079350306

~~€ 66,00~~ € 53,70

## 7939G

### Work jacket

- 100% stretch cotton, 220 g
- Slim fit

**New item**



XS	079390300
S	079390301
M	079390302
L	079390303
XL	079390304
XXL	079390305
XXXL	079390306

~~€ 41,00~~ € 34,00

## 7931G

### Work Bermuda shorts

- 100% stretch cotton, 220 g
- Slim fit

**New item**



XS	079310300
S	079310301
M	079310302
L	079310303
XL	079310304
XXL	079310305
XXXL	079310306

~~€ 30,00~~ € 24,60



# 50 Years in Motorsports



Technical Partner







998015616

8 014230 962542

The images are for reference only. Beta Utensili S.p.A. reserves the right to update and upgrade its product range without notice.



Beta Utensili S.p.A. | via Volta, 18 | 20845 Sovico (MB) | ph. +39 039 20771

[www.beta-tools.com](http://www.beta-tools.com)